

# Environment and Tools

## **Microsoft® MASM**

**Assembly-Language Development System  
Version 6.1**

**For MS-DOS® and Windows™ Operating Systems**

**Microsoft Corporation**

Information in this document is subject to change without notice. Companies, names, and data used in examples herein are fictitious unless otherwise noted. No part of this document may be reproduced or transmitted in any form or by any means, electronic or mechanical, for any purpose, without the express written permission of Microsoft Corporation.

©1992 Microsoft Corporation. All rights reserved.

Microsoft, MS, MS-DOS, XENIX, CodeView, and QuickC are registered trademarks and Windows and Windows NT are trademarks of Microsoft Corporation in the USA and other countries.

U.S. Patent No. 4955066

IBM is a registered trademark of International Business Machines Corporation.  
Intel is a registered trademark of Intel Corporation.  
UNIX is a registered trademark of American Telephone and Telegraph Company.  
BRIEF is a registered trademark of SDC Software Partners II L.P.  
Printed in the United States of America.

Document No. DB35751-1292

# Contents Overview

<b>Introduction</b> .....	<b>x x i</b>
<b>Part 1 The Programmer's WorkBench</b>	
Chapter 1 Introducing the Programmer's WorkBench .....	3
Chapter 2 Quick Start .....	7
Chapter 3 Managing Multimodule Programs .....	35
Chapter 4 User Interface Details .....	57
Chapter 5 Advanced PWB Techniques .....	77
Chapter 6 Customizing PWB .....	109
Chapter 7 Programmer's WorkBench Reference .....	131
<b>Part 2 The CodeView Debugger</b>	
Chapter 8 Getting Started with CodeView .....	293
Chapter 9 The CodeView Environment .....	319
Chapter 10 Special Topics .....	351
Chapter 11 Using Expressions in CodeView .....	375
Chapter 12 CodeView Reference .....	393
<b>Part 3 Compiling and Linking</b>	
Chapter 13 Linking Object Files with LINK .....	457
Chapter 14 Creating Module-Definition Files .....	491
Chapter 15 Using EXEHDR .....	513
<b>Part 4 Utilities</b>	
Chapter 16 Managing Projects with NMAKE .....	527
Chapter 17 Managing Libraries with LIB .....	581
Chapter 18 Creating Help Files with HELPMAKE .....	593
Chapter 19 Browser Utilities .....	615
Chapter 20 Using Other Utilities .....	631
<b>Part 5 Using Help</b>	
Chapter 21 Using Help .....	663
<b>Appendixes</b>	
Appendix A Error Messages .....	685
Appendix B Regular Expressions .....	845

iv Contents

---

Glossary..... 857

Index..... 873

# Contents

<b>Introduction</b> . . . . .	<b>xxi</b>
Scope and Organization of This Book . . . . .	xxii
Microsoft Support Services . . . . .	xxiii
Support Services Within the United States . . . . .	xxiii
Support Services Worldwide . . . . .	xxvi
Document Conventions . . . . .	xxxiii
<b>Part 1 The Programmer's WorkBench</b>	
<b>Chapter 1 Introducing the Programmer's WorkBench</b> . . . . .	<b>3</b>
What's in Part 1 . . . . .	4
Using the Tutorial . . . . .	4
Conventions in the Tutorial . . . . .	5
<b>Chapter 2 Quick Start</b> . . . . .	<b>7</b>
The PWB Environment . . . . .	7
The Microsoft Advisor . . . . .	8
Entering Text . . . . .	9
Saving a File . . . . .	10
Indenting Text with PWB . . . . .	11
Opening an Existing File . . . . .	14
Copying, Pasting, and Deleting Text . . . . .	16
Single-Module Builds . . . . .	18
Setting Build Options . . . . .	18
Setting Other Options . . . . .	21
Building the Program . . . . .	22
Fixing Build Errors . . . . .	23
Running the Program . . . . .	25
Debugging the Program . . . . .	26
Using CodeView to Isolate an Error . . . . .	26
Working Through a Program to Debug it . . . . .	29
Examining Memory in the Memory Window . . . . .	33
Where to Go from Here . . . . .	34
<b>Chapter 3 Managing Multimodule Programs</b> . . . . .	<b>35</b>
Multimodule Program Example . . . . .	35

---

Opening the Project . . . . .	36
Contents of a Project . . . . .	38
Dependencies in a Project . . . . .	39
Building a Multimodule Program . . . . .	40
Running the Program . . . . .	40
Project Maintenance . . . . .	41
Using Existing Projects . . . . .	42
Adding and Deleting a Project File . . . . .	44
Changing Assembler and Linker Options . . . . .	46
Changing Options for Individual Modules . . . . .	49
The Program Build Process . . . . .	51
Extending a PWB Project . . . . .	52
Using a Non-PWB Makefile . . . . .	55
Where to Go from Here . . . . .	56
<b>Chapter 4 User Interface Details . . . . .</b>	<b>57</b>
Starting PWB . . . . .	57
From the Command Line . . . . .	57
Using the Windows Operating System Program Manager . . . . .	58
Using the Windows Operating System File Manager . . . . .	59
The PWB Screen . . . . .	59
PWB Menus . . . . .	64
File . . . . .	64
Edit . . . . .	64
Search . . . . .	65
Project . . . . .	66
Run . . . . .	66
Options . . . . .	67
Browse . . . . .	68
Window . . . . .	69
Help . . . . .	70
Executing Commands . . . . .	70
Choosing Menu Commands . . . . .	70
Shortcut Keys . . . . .	71
Buttons . . . . .	72
Dialog Boxes . . . . .	72
<b>Chapter 5 Advanced PWB Techniques . . . . .</b>	<b>77</b>
Searching with PWB . . . . .	77
Searching by Visual Inspection . . . . .	78

Using the Find Command . . . . .	79
Using Regular Expressions . . . . .	82
Using the Source Browser . . . . .	88
Advanced Browser Database Information . . . . .	93
Executing Functions and Macros . . . . .	96
Executing Functions and Macros by Name . . . . .	98
Writing PWB Macros . . . . .	98
When Is a Macro Useful? . . . . .	99
Recording Macros . . . . .	99
Flow Control Statements . . . . .	102
User Input Statements . . . . .	104
<b>Chapter 6 Customizing PWB . . . . .</b>	<b>109</b>
Changing Key Assignments . . . . .	109
Changing Settings . . . . .	112
Customizing Colors . . . . .	114
Adding Commands to the Run Menu . . . . .	115
How PWB Handles Tabs . . . . .	118
PWB Configuration . . . . .	120
Autoloading Extensions . . . . .	121
The TOOLS.INI File . . . . .	122
TOOLS.INI Statement Syntax . . . . .	124
Environment Variables . . . . .	127
Current Status File CURRENT.STS . . . . .	128
Project Status Files . . . . .	129
<b>Chapter 7 Programmer's WorkBench Reference . . . . .</b>	<b>131</b>
PWB Command Line . . . . .	131
PWB Menus and Keys . . . . .	132
PWB Default Key Assignments . . . . .	135
Note on Available Keys . . . . .	139
PWB Functions . . . . .	140
Cursor-Movement Commands . . . . .	144
Predefined PWB Macros . . . . .	207
PWB Switches . . . . .	244
Extension Switches . . . . .	246
Filename-Parts Syntax . . . . .	247
Boolean Switch Syntax . . . . .	248
Browser Switches . . . . .	286
Help Switches . . . . .	287

**Part 2 The CodeView Debugger**

<b>Chapter 8 Getting Started with CodeView</b> . . . . .	<b>293</b>
Preparing Programs for Debugging . . . . .	293
General Programming Considerations . . . . .	294
Compiling and Linking . . . . .	295
Debugging Strategies . . . . .	297
Identifying the Bug . . . . .	297
Locating the Bug . . . . .	298
Setting up CodeView . . . . .	299
CodeView Files . . . . .	300
Configuring CodeView with TOOLS.INI . . . . .	301
CodeView TOOLS.INI Entries . . . . .	302
Memory Management and CodeView . . . . .	308
The CodeView Command Line . . . . .	308
Leaving CodeView . . . . .	309
Command-Line Options . . . . .	310
The CURRENT.STS State File . . . . .	316
<b>Chapter 9 The CodeView Environment</b> . . . . .	<b>319</b>
The CodeView Display . . . . .	319
The Menu Bar . . . . .	320
The Window Area . . . . .	320
The Status Bar . . . . .	321
CodeView Windows . . . . .	321
How to Use CodeView Windows . . . . .	321
The Source Windows . . . . .	324
The Watch Window . . . . .	324
The Command Window . . . . .	326
The Local Window . . . . .	328
The Register Window . . . . .	329
The 8087 Window . . . . .	330
The Memory Windows . . . . .	330
The Help Window . . . . .	332
CodeView Menus . . . . .	332
The File Menu . . . . .	332
The Edit Menu . . . . .	334
The Search Menu . . . . .	335
The Run Menu . . . . .	336
The Data Menu . . . . .	338



The Options Menu . . . . .	342
The Calls Menu . . . . .	346
The Windows Menu. . . . .	347
The Help Menu . . . . .	349
<b>Chapter 10 Special Topics . . . . .</b>	<b>351</b>
Debugging in the Windows Operating System . . . . .	351
Comparing CVW with CV . . . . .	351
Preparing to Run CVW . . . . .	352
Starting a Debugging Session . . . . .	353
CVW Commands . . . . .	357
CVW Debugging Techniques . . . . .	360
Debugging P-Code . . . . .	363
Requirements . . . . .	364
Preparing Programs . . . . .	365
P-Code Debugging Techniques . . . . .	365
P-Code Debugging Limitations . . . . .	367
Remote Debugging . . . . .	367
Requirements . . . . .	368
Remote Monitor Command-Line Syntax . . . . .	370
Starting a Remote Debugging Session . . . . .	371
<b>Chapter 11 Using Expressions in CodeView . . . . .</b>	<b>375</b>
Common Elements . . . . .	375
Line Numbers . . . . .	376
Registers . . . . .	377
Addresses . . . . .	378
Address Ranges . . . . .	379
Choosing an Expression Evaluator . . . . .	380
Using the C and C++ Expression Evaluators . . . . .	381
Additional Operators . . . . .	381
Unsupported Operators . . . . .	381
Restrictions and Special Considerations . . . . .	382
The Context Operator . . . . .	382
Numeric Constants . . . . .	384
String Literals . . . . .	385
Symbol Formats . . . . .	385
Using C++ Expressions . . . . .	386
Access Control . . . . .	386
Ambiguous References . . . . .	386

Inheritance .....	386
Constructors, Destructors, and Conversions .....	387
Overloading .....	388
Operator Functions .....	388
Debugging Assembly Language .....	389
Memory Operators .....	389
Register Indirection .....	390
Register Indirection with Displacement .....	391
Address of a Variable .....	391
PTR Operator .....	391
Strings .....	392
Array and Structure Elements .....	392
<b>Chapter 12 CodeView Reference .....</b>	<b>393</b>
CodeView Command Overview .....	398
CodeView Command Reference .....	400

### Part 3 Compiling and Linking

<b>Chapter 13 Linking Object Files with LINK .....</b>	<b>457</b>
New Features .....	457
Overview .....	458
LINK Output Files .....	459
LINK Syntax and Input .....	460
The objfiles Field .....	461
The exe file Field .....	462
The mapfile Field .....	463
The libraries Field .....	463
The deffile Field .....	466
Examples .....	467
Running LINK .....	468
Specifying Input with LINK Prompts .....	469
Specifying Input in a Response File .....	469
LINK Options .....	471
Specifying Options .....	471
The /ALIGN Option .....	472
The /BATCH Option .....	472
The /CO Option .....	473
The /CPARM Option .....	473
The /DOSSEG Option .....	474

The /DSALLOC Option .....	475
The /DYNAMIC Option .....	475
The /EXEPACK Option .....	475
The /FARCALL Option .....	476
The /HELP Option .....	477
The /HIGH Option .....	477
The /INFO Option .....	477
The /LINE Option .....	478
The /MAP Option .....	478
The /NOD Option .....	479
The /NOE Option .....	479
The /NOFARCALL Option .....	479
The /NOGROUP Option .....	480
The /NOI Option .....	480
The /NOLOGO Option .....	480
The /NONULLS Option .....	480
The /NOPACKC Option .....	481
The /NOPACKF Option .....	481
The /OLDOVERLAY Option .....	481
The /ONERROR Option .....	481
The /OV Option .....	482
The /PACKC Option .....	482
The /PACKD Option .....	483
The /PACKF Option .....	484
The /PAUSE Option .....	484
The /PCODE Option .....	485
The /PM Option .....	485
The /Q Option .....	485
The /r Option .....	486
The /SEG Option .....	486
The /STACK Option .....	487
The /TINY Option .....	487
The /W Option .....	488
The /? Option .....	488
Setting Options with the LINK Environment Variable .....	488
Setting the LINK Environment Variable .....	488
Behavior of the LINK Environment Variable .....	489
Clearing the LINK Environment Variable .....	489

LINK Temporary Files . . . . .	489
LINK Exit Codes . . . . .	490
<b>Chapter 14 Creating Module-Definition Files . . . . .</b>	<b>491</b>
New Features . . . . .	491
MS-DOS Programs . . . . .	491
Statements . . . . .	492
Overlays . . . . .	492
Overview . . . . .	492
Module Statements . . . . .	493
Syntax Rules . . . . .	494
The NAME Statement . . . . .	495
The LIBRARY Statement . . . . .	496
The DESCRIPTION Statement . . . . .	496
The STUB Statement . . . . .	497
The APPLoader Statement . . . . .	498
The EXETYPE Statement . . . . .	498
The PROTMODE Statement . . . . .	499
The REALMODE Statement . . . . .	500
The STACKSIZE Statement . . . . .	500
The HEAPSIZE Statement . . . . .	500
The CODE Statement . . . . .	501
The DATA Statement . . . . .	501
The SEGMENTS Statement . . . . .	502
CODE, DATA, and SEGMENTS Attributes . . . . .	503
The OLD Statement . . . . .	505
The EXPORTS Statement . . . . .	505
The IMPORTS Statement . . . . .	506
The FUNCTIONS Statement . . . . .	508
The INCLUDE Statement . . . . .	510
Reserved Words . . . . .	510
<b>Chapter 15 Using EXEHDR . . . . .</b>	<b>513</b>
Running EXEHDR . . . . .	513
The EXEHDR Command Line . . . . .	513
EXEHDR Options . . . . .	514
Executable-File Format . . . . .	515
EXEHDR Output: MS-DOS Executable File . . . . .	516
EXEHDR Output: Segmented-Executable File . . . . .	518
DLL Header Differences . . . . .	519

Segment Table .....	520
Exports Table .....	520
EXEHDR Output: Verbose Output .....	521
MS-DOS Header Information .....	521
New .EXE Header Information .....	521
Tables .....	523
Relocations .....	523

## Part 4 Utilities

<b>Chapter 16 Managing Projects with NMAKE .....</b>	<b>527</b>
New Features .....	527
Overview .....	528
Running NMAKE .....	529
Command-Line Options .....	529
NMAKE Command File .....	533
The TOOLS.INI File .....	534
Contents of a Makefile .....	535
Using Special Characters as Literals .....	535
Wildcards .....	536
Comments .....	536
Long Filenames .....	537
Description Blocks .....	537
Dependency Line .....	538
Targets .....	538
Dependents .....	542
Commands .....	543
Command Syntax .....	543
Command Modifiers .....	544
Exit Codes from Commands .....	545
Filename-Parts Syntax .....	546
Inline Files .....	547
Macros .....	550
User-Defined Macros .....	551
Using Macros .....	554
Special Macros .....	554
Substitution Within Macros .....	560
Substitution Within Predefined Macros .....	561
Environment-Variable Macros .....	561
Inherited Macros .....	563

Precedence Among Macro Definitions . . . . .	563
Inference Rules . . . . .	563
Inference Rule Syntax . . . . .	564
Inference Rule Search Paths . . . . .	565
User-Defined Inference Rules . . . . .	566
Predefined Inference Rules . . . . .	567
Inferred Dependents . . . . .	569
Precedence Among Inference Rules . . . . .	570
Directives . . . . .	570
Dot Directives . . . . .	570
Preprocessing Directives . . . . .	572
Sequence of NMAKE Operations . . . . .	576
A Sample NMAKE Makefile . . . . .	578
NMAKE Exit Codes . . . . .	580
<b>Chapter 17 Managing Libraries with LIB . . . . .</b>	<b>581</b>
Overview . . . . .	581
Running LIB . . . . .	582
The LIB Command Line . . . . .	582
LIB Command Prompts . . . . .	582
The LIB Response File . . . . .	583
Specifying LIB Fields . . . . .	583
The Library File . . . . .	584
LIB Options . . . . .	584
LIB Commands . . . . .	586
The Cross-reference Listing . . . . .	590
The Output Library . . . . .	590
Examples . . . . .	591
LIB Exit Codes . . . . .	592
<b>Chapter 18 Creating Help Files with HELPMAKE . . . . .</b>	<b>593</b>
Overview . . . . .	594
Running HELPMAKE . . . . .	595
Encoding . . . . .	595
Decoding . . . . .	597
Getting Help . . . . .	598
Other Options . . . . .	599
Source File Formats . . . . .	599
Elements of a Help Source File . . . . .	600
Defining a Topic . . . . .	600

Creating Links to Other Topics . . . . .	601
Formatting Topic Text . . . . .	604
Dot and Colon Commands . . . . .	605
Other Help Text Formats . . . . .	609
Rich Text Format . . . . .	609
Minimally Formatted ASCII . . . . .	612
Context Prefixes . . . . .	613
<b>Chapter 19 Browser Utilities . . . . .</b>	<b>615</b>
Overview of Database Building . . . . .	616
Preparing to Build a Database . . . . .	616
How BSCMAKE Builds a Database . . . . .	616
Methods for Increasing Efficiency . . . . .	617
BSCMAKE . . . . .	618
System Requirements for BSCMAKE . . . . .	618
The BSCMAKE Command Line . . . . .	619
BSCMAKE Options . . . . .	620
Using a Response File . . . . .	622
BSCMAKE Exit Codes . . . . .	623
SBRPACK . . . . .	623
Overview of SBRPACK . . . . .	624
The SBRPACK Command Line . . . . .	624
SBRPACK Exit Codes . . . . .	626
CREF . . . . .	626
Using CREF . . . . .	626
Difference from Previous Releases . . . . .	629
<b>Chapter 20 Using Other Utilities . . . . .</b>	<b>631</b>
CVPACK . . . . .	631
Overview of CVPACK . . . . .	632
The CVPACK Command Line . . . . .	632
CVPACK Exit Codes . . . . .	633
H2INC . . . . .	633
Basic H2INC Operation . . . . .	634
H2INC Syntax and Options . . . . .	635
Converting Data and Data Structures . . . . .	638
Converting Function Prototypes . . . . .	648
Summary of H2INC-Recognized Keywords and Pragmas . . . . .	651
IMPLIB . . . . .	652
About Import Libraries . . . . .	652

The IMPLIB Command Line . . . . .	653
Options . . . . .	653
RM, UNDEL, and EXP . . . . .	654
Overview of the Backup Utilities . . . . .	654
The RM Utility . . . . .	654
The UNDEL Utility . . . . .	655
The EXP Utility . . . . .	656
WX/WXServer . . . . .	657
Running WX/WXServer . . . . .	657

## Part 5 Using Help

<b>Chapter 21 Using Help . . . . .</b>	<b>663</b>
Structure of the Microsoft Advisor . . . . .	663
Navigating Through the Microsoft Advisor . . . . .	664
Using the Help Menu . . . . .	665
Using the Mouse and the F1 Key . . . . .	666
Using Hyperlinks . . . . .	666
Using Help Windows and Dialog Boxes . . . . .	667
Accessing Different Types of Information . . . . .	669
Using Different Help Screens . . . . .	672
Using Help in PWB . . . . .	673
Opening a Help File . . . . .	673
Global Search . . . . .	674
Using QuickHelp . . . . .	675
Using the /Help Option . . . . .	676
Using the QH Command . . . . .	676
Managing Help Files . . . . .	679
Managing Many Help Files . . . . .	680

## Appendixes

<b>Appendix A Error Messages . . . . .</b>	<b>685</b>
Error Message Lists . . . . .	685
BSCMAKE Error Messages . . . . .	688
CodeView C/C++ Expression Evaluator Errors . . . . .	692
CodeView Error Messages . . . . .	700
CVPACK Error Messages . . . . .	716
EXEHDR Error Messages . . . . .	720
Math Coprocessor Error Messages . . . . .	722



H2INC Error Messages . . . . .	724
HELPMAKE Error Messages . . . . .	761
IMPLIB Error Messages . . . . .	767
LIB Error Messages . . . . .	769
LINK Error Messages . . . . .	775
ML Error Messages . . . . .	798
NMAKE Error Messages . . . . .	828
PWB Error Messages . . . . .	840
SBRPACK Error Messages . . . . .	842
<b>Appendix B Regular Expressions . . . . .</b>	<b>845</b>
Regular-Expression Summaries . . . . .	845
UNIX Regular-Expression Syntax . . . . .	848
Tagged Regular Expressions . . . . .	850
Tagged Expressions in Build:Message . . . . .	852
Justifying Tagged Expressions . . . . .	852
Predefined Regular Expressions . . . . .	853
Non-UNIX Regular-Expression Syntax . . . . .	854
Non-UNIX Matching Method . . . . .	855
<b>Glossary . . . . .</b>	<b>857</b>
<b>Index . . . . .</b>	<b>873</b>

# Figures and Tables

## Figures

Figure 2.1	PWB Display	8
Figure 3.1	The SHOW Project	36
Figure 3.2	The PWB Build Process	51
Figure 4.1	User Interface Elements	60
Figure 4.2	Window Elements	61
Figure 4.3	Status Bar Elements	62
Figure 4.4	PWB Menu Elements	63
Figure 4.5	Dialog Box Elements	73
Figure 4.6	Key Box and Check Box	74
Figure 5.1	Regular Expression Example	83
Figure 5.2	Complex Regular Expression Example	84
Figure 6.1	How PWB Displays Tabs	119
Figure 7.1	Arranged Windows	213
Figure 7.2	Vertical Tiling	278
Figure 7.3	Horizontal Tiling	278
Figure 9.1	CodeView Display	320
Figure 15.1	Format for a Segmented-Executable File	516
Figure 16.1	NMAKE Description Block	537
Figure 21.1	Microsoft Advisor Global Contents Screen	664

## Tables

Table 7.1	File Menu and Keys	132
Table 7.2	Edit Menu and Keys	133
Table 7.3	Search Menu and Keys	133
Table 7.4	Project Menu and Keys	134
Table 7.5	Run Menu and Keys	134
Table 7.6	Browse Menu and Keys	134
Table 7.7	Window Menu and Keys	135
Table 7.8	Help Menu and Keys	135
Table 7.9	PWB Default Key Assignments	136
Table 7.10	PWB Functions	140
Table 7.11	Cursor-Movement Commands	145
Table 7.12	PWB Macros	208
Table 7.13	PWB Color Names	252
Table 7.14	PWB Color Values	254

Table 8.1	CodeView TOOLS.INI Entries. . . . .	302
Table 8.2	CodeView Command-Line Options . . . . .	310
Table 9.1	Moving Around with the Keyboard . . . . .	323
Table 11.1	Registers. . . . .	377
Table 12.1	Register Names . . . . .	395
Table 12.2	CodeView Command Summary . . . . .	398
Table 14.1	Module Statements . . . . .	493
Table 16.1	Predefined Inference Rules . . . . .	567
Table 16.2	Binary Operators for Preprocessing . . . . .	574
Table 18.1	Formatting Attributes . . . . .	605
Table 18.2	Dot and Colon Commands . . . . .	606
Table 18.3	RTF Formatting Codes . . . . .	610
Table 18.4	Microsoft Product Context Prefixes . . . . .	613
Table 18.5	Standard h. Contexts . . . . .	614
Table A.1	Error Codes Listed by Utility. . . . .	686
Table A.2	Error Codes Listed by Error Code Range . . . . .	687
Table B.1	UNIX Regular-Expression Summary . . . . .	845
Table B.2	UNIX Predefined Expressions . . . . .	846
Table B.3	CodeView Regular Expressions. . . . .	847
Table B.4	Non-UNIX Regular-Expression Summary . . . . .	847
Table B.5	Non-UNIX Predefined Expressions. . . . .	848
Table B.6	UNIX Regular-Expression Syntax. . . . .	848
Table B.7	Predefined Regular Expressions and Definitions . . . . .	853
Table B.8	Non-UNIX Regular Expression Syntax. . . . .	854



---

# Introduction

Microsoft® Macro Assembler (MASM) includes a full set of development tools — editor, compiler, linker, debugger, and browser — for writing, compiling, and debugging your programs. You can work within the Microsoft Programmer's WorkBench (PWB) integrated environment, or you can use the tools separately to develop your programs.

*Environment and Tools* describes the following development tools:

- ◆ The Programmer's WorkBench (PWB). PWB is a comprehensive tool for application development. Within its environment is everything you need to create, build, browse, and debug your programs. Its macro language gives you control over not only editing but also build operations and other PWB functions.
- ◆ The Microsoft® CodeView™ debugger. This is a diagnostic tool for finding errors in your programs. Two versions of CodeView are described: one for MS-DOS® and one for Microsoft Windows™. Each CodeView version has specialized commands for its operating environment, as well as other commands for examining code and data, setting breakpoints, and controlling your program's execution.
- ◆ LINK, the Microsoft Segmented-Executable Linker. The linker combines object files and libraries into an executable file, either an application or a dynamic-link library (DLL).
- ◆ EXEHDR, the Microsoft EXE File Header Utility. EXEHDR displays and modifies the contents of an executable-file header.
- ◆ NMAKE, the Microsoft Program Maintenance Utility. NMAKE simplifies project maintenance. Once you specify which project files depend on others, you can use NMAKE to automatically execute the commands that will update your project when any file has changed.
- ◆ LIB, the Microsoft Library Manager. LIB creates and maintains standard libraries. With LIB, you can create a library file and add, delete, and replace modules.

- ◆ HELPMAKE, the Microsoft Help File Maintenance Utility. HELPMAKE creates and maintains Help files. You can use HELPMAKE to create a Help file or to customize the Microsoft Help files.
- ◆ BSCMAKE, the Microsoft Browser Database Maintenance Utility, and SBRPACK, the Microsoft Browse Information Compactor. BSCMAKE creates browser files for use with the PWB Source Browser. SBRPACK compresses the files that are used by BSCMAKE.

*Environment and Tools* also describes these special-purpose utilities:

- ◆ H2INC, the Microsoft C Header Translation Utility. H2INC translates C header files into MASM-compatible include files.
- ◆ CVPACK, the Microsoft Debugging Information Compactor. CVPACK compresses the size of debugging information in an executable file.
- ◆ IMPLIB, the Microsoft Import Library Manager. IMPLIB creates an import library that resolves external references from a Windows-based application to a DLL.
- ◆ RM, the Microsoft File Removal Utility; UNDEL, the Microsoft File Undelete Utility; and EXP, the Microsoft File Expunge Utility. These utilities manage, delete, and recover backup files.

## Scope and Organization of This Book

This book has five parts and five appendixes to give you complete information about PWB, CodeView, and the utilities included with MASM.

Part 1 is a brief PWB tutorial and comprehensive reference. The first three chapters introduce PWB and provide a tutorial that describes the features of the integrated environment and how to use them. Chapters 4, 5, and 6 contain detailed information on the interface, advanced PWB techniques, and customization. Chapter 7 contains a complete reference to PWB's default keys and all functions, predefined macros, and switches.

Part 2 provides full information on the Microsoft CodeView debugger. Chapter 8 tells how to prepare programs for debugging, how to start CodeView, and how to customize CodeView's interface and memory usage. Chapter 9 describes the environment, including the CodeView menu commands and the format and use of each CodeView window. Chapter 10 explains how to use expressions, including the C and C++ expression evaluators. Chapter 11 describes techniques for debugging Windows-based programs. Chapter 12 contains a complete reference to CodeView commands.

The chapters in Parts 3 and 4 describe the utilities. These chapters are principally for command-line users. Even if you're using PWB, however, you may find the

detailed information in Parts 3 and 4 helpful for a better understanding of how each tool contributes to the program development process.

Part 3 provides information about compiling and linking your program. LINK command-line syntax and options are covered in Chapter 13. The contents and use of module-definition files are explained in Chapter 14. Chapter 15 describes how to use EXEHDR to examine the file header of a program.

Part 4 presents the other utilities. NMAKE, the utility for automating project management, is described in Chapter 16. Chapter 17 covers LIB, used in managing standard libraries. Procedures for using HELPMAKE to create and maintain Help files are in Chapter 18. The tools for creating a browser database are discussed in Chapter 19. Finally, Chapter 20 describes how to use the following special-purpose utilities: H2INC, CVPACK, IMPLIB, RM, UNDEL, and EXP.

Part 5 presents the Microsoft Advisor Help system and the QuickHelp program. It describes the structure of the Help files, how to navigate through the Help system, and how to manage Help files.

The appendixes provide supplementary information. Appendix A describes error messages. Appendix B describes regular expressions for use in PWB and CodeView.

## Microsoft Support Services

Microsoft offers a variety of no-charge and fee-based support options to help you get the most from your Microsoft product. For an explanation of these options, please see one of the following sections:

- ◆ If you are in the United States, see “Support Services Within the United States.”
- ◆ If you are outside the United States, see “Support Services Worldwide.”

## Support Services Within the United States

If you have a question about Microsoft Macro Assembler (MASM), one of the following resources may help you find an answer:

- ◆ The index in the product documentation and other printed product documentation.
- ◆ Context-sensitive online Help available from the Help menu.

- ◆ The README files that come with your product disks. These files provide general information that became available after the books in the product package were published.
- ◆ Electronic options such as CompuServe forums or bulletin board systems, if available.

If you cannot find the information you need, you can obtain product support through several methods. In addition, you can locate training and consultation services in your area.

For information about Microsoft incremental fee-based support service options, call Microsoft Inside Sales at (800) 227-4679, Monday through Friday, between 6:30 a.m. and 5:30 p.m. Pacific time.

---

**Note** Microsoft's support services are subject to Microsoft's prices, terms, and conditions in place in each country at the time the services are used.

---

## Microsoft Forums on CompuServe

Microsoft Product Support Services are available on several CompuServe forums. For an introductory CompuServe membership kit specifically for Microsoft users, dial (800) 848-8199 and ask for operator 230. If you are already a CompuServe member, type `go microsoft` at any ! prompt.

## Microsoft Product Support Services

You can reach Microsoft Product Support Services Monday through Friday between 6:00 a.m. and 6:00 p.m. Pacific time.

- ◆ For assistance with Microsoft MASM, dial (206) 646-5109.

When you call, you should be at your computer with Microsoft MASM running and the product documentation at hand. Have your file open and be prepared to give the following information:

- ◆ The version of Microsoft MASM you are using.
- ◆ The type of hardware you are using, including network hardware, if applicable.
- ◆ The operating system you are using.
- ◆ The exact wording of any messages that appeared on your screen.
- ◆ A description of what happened and what you were trying to do when the problem occurred.
- ◆ A description of how you tried to solve the problem.



---

## Microsoft Product Support for the Deaf and Hard-of-Hearing

Microsoft Product Support Services are available for the deaf and hard-of-hearing Monday through Friday between 6:00 a.m. and 6:00 p.m. Pacific time.

Using a special TDD/TT modem, dial (206) 635-4948.

## Product Training and Consultation Services

Within the United States, Microsoft offers the following services for training and consultation:

### Authorized Training Centers

Microsoft Authorized Training Centers offer several services for Microsoft product users. These include:

- ◆ Customized training for users and trainers.
- ◆ Training material development.
- ◆ Consulting services.

For information about the training center nearest you, call Microsoft Consumer Sales at (800) 426-9400 Monday through Friday between 6:30 a.m. and 5:30 p.m. Pacific time.

### Consultant Referral Service

Microsoft's Consultant Relations Program can refer you to an independent consultant in your area. These consultants are skilled in:

- ◆ Macro development and translation.
- ◆ Database development.
- ◆ Custom interface design.

For information about the consultants in your area, call the Microsoft Consultant Relations Program at (800) 227-4679, extension 56042, Monday through Friday between 6:30 a.m. and 5:30 p.m. Pacific time.

## Support Services Worldwide

If you are outside the United States and have a question about Microsoft MASM, Microsoft offers a variety of no-charge and fee-based support options. To solve your problem, you can:

- ◆ Consult the index in the product documentation and other printed product documentation.
- ◆ Check context-sensitive online Help available from the Help menu.
- ◆ Check the README files that come with your product disks. These files provide general information that became available after the books in the product package were published.
- ◆ Consult electronic options such as CompuServe forums or bulletin board systems, if available.

If you cannot find a solution, you can receive information on how to obtain product support by contacting the Microsoft subsidiary office that serves your country.

---

**Note** Microsoft's support services are subject to Microsoft's prices, terms, and conditions in place in each country at the time the services are used.

---

### Calling a Microsoft Subsidiary Office

When you call, you should be at your computer with Microsoft MASM running and the product documentation at hand. Have your file open and be prepared to give the following information:

- ◆ The version of Microsoft MASM you are using.
- ◆ The type of hardware you are using, including network hardware, if applicable.
- ◆ The operating system you are using.
- ◆ The exact wording of any messages that appeared on your screen.
- ◆ A description of what happened and what you were trying to do when the problem occurred.
- ◆ A description of how you tried to solve the problem.

Microsoft subsidiary offices and the countries they serve are listed below.

Area	Telephone Numbers
Argentina	Microsoft de Argentina S.A. Phone: (54) (1) 814-0356 Fax: (54) (1) 814-0372
Australia	Microsoft Pty. Ltd. Phone: (61) (02) 870-2200 Fax: (02) 805-1108 Bulletin Board Service: (612) 870-2348 Technical Support: (61) (02) 870-2131 Sales Information Centre: (02) 870-2100
Austria	Microsoft Ges.m.b.H. Phone: 0222 - 68 76 07 Fax: 0222 - 68 16 2710 Information: 060 - 89 - 247 11 101 Prices, updates, etc.: 060 - 89 - 3176 1199 CompuServe: msce (Microsoft Central Europe) Technical support: Windows, Windows for Workgroups, Microsoft Mail: 0660 - 65 - 10 Microsoft Excel for Windows, Microsoft Excel for OS/2, PowerPoint for Windows: 0660 - 65 - 11 Word for MS-DOS, Windows Write: 0660 65 - 12 Word for Windows, Word for OS/2: 0660 - 65 - 13 Works for MS-DOS, Works for Windows, Publisher, WorksCalc, WorksText: 0660 - 65 - 14 C PDS, FORTRAN PDS, Pascal, Macro Assembler PDS, QuickC, QuickC for Windows, QuickPascal, QuickAssembler, Profiler: 0660 - 65 - 15 COBOL PDS, Basic PDS, QuickBASIC, Visual Basic: 0660 - 65 - 16 MS-DOS: 0660 - 65 - 17 Macintosh Software: 0660 - 65 - 18 Project for Windows, Project for MS-DOS, Multiplan, Mouse, Flight Simulator, Paintbrush, Chart: 0660 - 67 - 38 FoxPro: 0660 - 67 - 61
Baltic States	See Germany
Belgium	Microsoft NV Phone: 02-7322590 Fax: 02-7351609 Technical Support Bulletin Board Service: 02-7350045 (1200/2400/9600 baud, 8 bits, no parity, 1 stop bit, ANSI terminal emulation) (Dutch speaking) Technical Support: 02-5133274 (English speaking) Technical Support: 02-5023432 (French speaking) Technical Support: 02-5132268 Technical Support Fax: (31) 2503-24304
Bermuda	See Venezuela
Bolivia	See Argentina

**xxviii Environment and Tools**

---

<b>Area</b>	<b>Telephone Numbers</b>
Brazil	Microsoft Informatica Ltda. Phone: (55) (11) 530-4455 Fax: (55) (11) 240-2205 Technical Support Phone: (55) (11) 533-2922 Technical Support Fax: (55) (11) 241-1157 Technical Support Bulletin Board Service: (55) (11) 543-9257
Canada	Microsoft Canada Inc. Phone: 1 (416) 568-0434 Fax: 1 (416) 568-4689 Technical Support Phone: 1 (416) 568-3503 Technical Support Facsimile: 1 (416) 568-4689 Technical Support Bulletin Board Service: 1 (416) 507-3022
Caribbean Countries	See Venezuela
Central America	See Venezuela
Chile	See Argentina
Colombia	See Venezuela
Denmark	Microsoft Denmark AS Phone: (45) (44) 89 01 00 Fax: (45) (44) 68 55 10
Ecuador	See Venezuela
England	Microsoft Limited Phone: (44) (734) 270000 Fax: (44) (734) 270002 Upgrades: (44) (81) 893-8000 Technical Support: Main Line (All Products): (44) (734) 271000 Windows Direct Support Line: (44) (734) 271001 Database Direct Support Line: (44) (734) 271126 MS-DOS 5 Warranty Support: (44) (734) 271900 MS-DOS 5 Fee Support Line: (44) (891) 315500 OnLine Service Assistance: (44) (734) 270374 Bulletin Board Service: (44) (734) 270065 (2400 Baud) Fax Information Service: (44) (734) 270080
Finland	Microsoft OY Phone: (358) (0) 525 501 Fax: (358) (0) 522 955
France	Microsoft France Phone: (33) (1) 69-86-46-46 Telex: MSPARIS 604322F Fax: (33) (1) 64-46-06-60 Technical Support Phone: (33) (1) 69-86-10-20 Technical Support Fax: (33) (1) 69-28-00-28

Area	Telephone Numbers
French Polynesia	See France
Germany	<p>Microsoft GmbH  Phone: 089 - 3176-0  Telex: (17) 89 83 28 MS GMBH D  Fax: 089 - 3176-1000  Information: 0130 - 5099  Prices, updates, etc.: 089 - 3176 1199  Bulletin board, device drivers, tech notes : BTX: microsoft# or *610808000#  CompuServe: msce (Microsoft Central Europe)  Technical support:  Windows, Windows for Workgroups, Microsoft Mail: 089 - 3176 - 1110  Microsoft Excel for Windows, Microsoft Excel for OS/2, PowerPoint for Windows: 089 - 3176 - 1120  Word for MS-DOS, Windows Write: 089 - 3176 - 1130  Word for Windows, Word for OS/2: 089 - 3176 - 1131  Works for MS-DOS, Works for Windows, Publisher, WorksCalc, WorksText: 089 - 3176 - 1140  C PDS, FORTRAN PDS, Pascal, Macro Assembler PDS, QuickC, QuickC for Windows, QuickPascal, QuickAssembler, Profiler: 089 - 3176 - 1150  COBOL PDS, Basic PDS, QuickBASIC, Visual Basic: 089 - 3176 - 1151  MS-DOS: 089 - 3176 - 1152  Macintosh Software: 089 - 3176 - 1160  Project for Windows, Project for MS-DOS, Multiplan, Mouse, Flight Simulator, Paintbrush, Chart: 089 - 3176 - 1170  FoxPro: 089 - 3176 - 1180</p>
Hong Kong	<p>Microsoft Hong Kong Limited  Technical Support: (852) 804-4222</p>
Ireland	See England
Israel	<p>Microsoft Israel Ltd.  Phone: 972-3-752-7915  Fax: 972-3-752-7919</p>
Italy	<p>Microsoft SpA  Phone: (39) (2) 269121  Telex: 340321 I  Fax: (39) (2) 21072020  Technical Support:  Microsoft Excel for Windows, Project for Windows, Works for Windows: (39) (2) 26901361  Word, Works for MS-DOS: (39) (2) 26901362  Windows, PowerPoint, Publisher, Windows for Workgroups, Works : (39) (2) 26901363  Basic, COBOL, Visual Basic, MS-DOS-based, Fox Products: (39) (2) 26901364  C, FORTRAN, Pascal, Macro Assembler (MASM), and SDKs: (39) (2) 26901354  LAN Manager, SQL Server, Microsoft Mail, Microsoft Mail Gateways: (39) (2) 26901356</p>

xxx **Environment and Tools**

---

<b>Area</b>	<b>Telephone Numbers</b>
Japan	Microsoft Company Ltd. Phone: (81) (3) 3363-1200 Fax: (81) (3) 3363-1281 Technical Support: MS-DOS-based Applications: (81) (3) 3363-0160 Windows-based Applications: (81) (3) 3363-5040 Language Products (Microsoft C, Macro Assembler [MASM], QuickC): (81) (3) 3363-7610 Language Products (Basic, FORTRAN, Visual Basic, Quick Basic): (81) (3) 3363-0170 All Products Technical Support Fax: (81) (3) 3363-9901
Korea	Microsoft CH Phone: (82) (2) 552-9505 Fax: (82) (2) 555-1724 Technical Support: (82) (2) 563-9230
Liechtenstein	See Switzerland (German speaking)
Luxemburg	Microsoft NV Phone: (32) 2-7322590 Fax: (32) 2-7351609 Technical Support Bulletin Board Service: (31) 2503-34221 (1200/2400/9600 baud, 8 bits, No parity, 1 stop bit, ANSI terminal emulation) (Dutch speaking) Technical Support: (31) 2503-77877 (English speaking) Technical Support: (31) 2503-77853 (French speaking) Technical Support: (32) 2-5132268 Technical Support Fax: (31) 2503-24304
México	Microsoft México, S.A. de C.V. Phone: (52) (5) 325-0910 Fax: (52) (5) 280-0198 Technical Support: (52) (5) 325-0912 Sales: (52) (5) 325-0911
Netherlands	Microsoft BV Phone: 02503-13181 Fax: 02503-37761 Technical Support Bulletin Board Service: 02503-34221 (1200/2400/9600 baud, 8 bits, No parity, 1 stop bit, ANSI terminal emulation) (Dutch speaking) Technical Support: 02503-77877 (English speaking) Technical Support: 02503-77853 Technical Support Fax: 02503-24304
New Zealand	Technology Link Centre Phone: 64 (9) 358-3724 Fax: 64 (9) 358-3726 Technical Support Applications: 64 (9) 357-5575
Northern Ireland	See England

---

<b>Area</b>	<b>Telephone Numbers</b>
Norway	Microsoft Norway AS Phone: (47) (2) 95 06 65 Fax: (47) (2) 95 06 64 Technical Support: (47) (2) 18 35 00
Papua New Guinea	See Australia
Paraguay	See Argentina
Peru	See Venezuela
Portugal	MSFT, Lda. Phone: (351) 1 4412205 Fax: (351) 1 4412101
Puerto Rico	See Venezuela
Republic of China	Microsoft Taiwan Corp. Phone: (886) (2) 504-3122 Fax: (886) (2) 504-3121
Republic of Ireland	See England
Scotland	See England
Spain	Microsoft Iberica SRL Phone: (34) (1) 804-0000 Fax: (34) (1) 803-8310 Technical Support: (34) (1) 803-9960
Sweden	Microsoft AB Phone: (46) (8) 752 56 00 Fax: (46) (8) 750 51 58 Technical Support: Applications: (46) (8) 752 68 50 Development and Network products: (46) (8) 752 60 50 MS-DOS: (46) (071) 21 05 15 (SEK 4.55/min) Sales Support: (46) (8) 752 56 30 Bulletin Board Service: (46) (8) 750 47 42 Fax Information Service: (46) (8) 752 29 00

Area	Telephone Numbers
Switzerland	(German speaking) Microsoft AG Phone: 01 - 839 61 11 Fax: 01 - 831 08 69 Information: 0049 - 89 - 247 11 101 Prices, updates, etc.: 0049 - 89 - 3176 1199 CompuServe: msce (Microsoft Central Europe) Technical support: Windows, Windows for Workgroups, Microsoft Mail: 01 - 342 - 4085 Microsoft Excel for Windows, Microsoft Excel for OS/2, PowerPoint for Windows: 01 - 342 - 4082 Word for MS-DOS, Windows Write: 01 - 342 - 4083 Word for Windows, Word for OS/2: 01 - 342 - 4087 Works for MS-DOS, Works for Windows, Publisher, WorksCalc, WorksText: 01 - 342 - 4084 C PDS, FORTRAN PDS, Pascal, Macro Assembler PDS, QuickC, QuickC for Windows, QuickPascal, QuickAssembler, Profiler: 01 - 342 - 4036 COBOL PDS, Basic PDS, QuickBASIC, Visual Basic: 01 - 342 - 4086 MS-DOS: 01 - 342 - 2152 Macintosh Software: 01 - 342 - 4081 Project for Windows, Project for MS-DOS, Multiplan, Mouse, Flight Simulator, Paintbrush, Chart : 01 - 342 - 0322 FoxPro: 01 / 342 - 4121  (French speaking) Microsoft SA, office Nyon Phone: 022 - 363 68 11 Fax: 022 - 363 69 11 Technical support: 022 - 738 96 88
Uruguay	See Argentina
Venezuela	Corporation MS 90 de Venezuela S.A. Phone: 0058.2.914739 Fax: 0058.2.923835
Wales	See England
Venezuela	Phone: 0058.2.914739 Fax: 0058.2.923835



## Document Conventions

This book uses the following typographic conventions:

Examples	Description
README.TXT, COPY, LINK, /CO	Uppercase (capital) letters indicate filenames, MS-DOS commands, and the commands to run the tools. Uppercase is also used for command-line options, unless the option must be lowercase.
<b>printf, IMPORT</b>	Bold letters indicate keywords, library functions, reserved words, and CodeView commands. Keywords are required unless enclosed in double brackets as explained below.
<i>expression</i>	Words in italic are placeholders for information that you must supply (for example, a function argument).
[[ <i>option</i> ]]	Items inside double square brackets are optional.
{ <i>choice1</i>   <i>choice2</i> }	Braces and a vertical bar indicate a choice between two or more items. You must choose one of the items unless all the items are also enclosed in double square brackets.
CL ONE.C TWO.C	This font is used for program examples, user input, program output, and error messages within the text.
Repeating elements...	Three horizontal dots following an item indicate that more items having the same form may follow.
while( ) { . . . }	Three vertical dots following a line of code indicate that part of the example program has intentionally been omitted.
F1, ALT+A	Small capital letters indicate the names of keys and key sequences, such as ENTER and CTRL+C. A plus (+) indicates a combination of keys. For example, CTRL+E means to hold down the CTRL key while pressing the E key.  The cursor-movement keys on the numeric keypad are called ARROW keys. Individual ARROW keys are referred to by the direction of the arrow on the top of the key (LEFT, RIGHT, UP, DOWN). Other keys are referred to by the name on the top of the key (PGUP, PGDN).

Examples	Description
<b>Arg Meta Delete</b> (ALT+A ALT+A SHIFT+DEL)	A bold series of names followed by a series of keys indicates a sequence of PWB functions that you can use in a macro definition, type in a dialog box, or execute directly by pressing the sequence of keys. In this book, these keys are the default keys for the corresponding functions. Some functions are not assigned to a key, and the word “Unassigned” appears in the place of a key. In PWB Help, the current key that is assigned to the function is shown.
“defined term”	Quotation marks usually indicate a new term defined in the text.
dynamic-link library (DLL)	Acronyms are usually spelled out the first time they are used.

P A R T 1

# The Programmer's WorkBench

Chapter 1	Introducing the Programmer's WorkBench .....	3
Chapter 2	Quick Start. ....	7
Chapter 3	Managing Multimodule Programs .....	35
Chapter 4	User Interface Details .....	57
Chapter 5	Advanced PWB Techniques .....	77
Chapter 6	Customizing PWB. ....	109
Chapter 7	Programmer's WorkBench Reference .....	131



## CHAPTER 1

# Introducing the Programmer's WorkBench

The Microsoft Programmer's WorkBench (PWB) is a powerful tool for application development. PWB combines the following features:

- ◆ A full-featured programmer's text editor.
- ◆ An extensible "build engine" which allows you to assemble and link your programs using the PWB environment. The build engine can be extended to support any programming tool.
- ◆ Error-message browsing. Once a build completes, you can step through the build messages, fixing errors in your source programs.
- ◆ A Source Browser. When working with large systems, it is often difficult to remember where program symbols are accessed and defined. The Source Browser maintains a database that allows you to go quickly to where a given variable, function, type, class, or macro is defined or referenced.
- ◆ An extensible Help system. The Microsoft Advisor Help system provides a complete reference on using PWB and MASM. You can also write new Help files and seamlessly integrate them into the Help system to document your own library routines or naming conventions.
- ◆ A macro language that can control editing functions, program builds, and other PWB operations.

For increased flexibility, you can write extensions to PWB. These extensions can perform tasks that are inconvenient in the PWB macro language. For example, you can write extensions to perform file translations, source-code formatting, text justification, and so on. As with the macro language, PWB extensions have full access to most PWB capabilities. For information about how to write PWB extensions, see the Microsoft Advisor Help system (choose "PWB Extensions" from the main Help table of contents).

PWB comes with extensions for C/C++, Basic, and Fortran, in addition to assembly language, to facilitate mixed-language programming. To install one of these

extensions, simply rename its corresponding .XXT file to a .MXT file in the \BIN subdirectory where you installed MASM, as described in *Getting Started*. Also, because an increasing number of programmers are using C++, the PWB Browser extension supports classes.

## What's in Part 1

This part of the book introduces you to the fundamentals of PWB. Chapter 2, “Quick Start,” shows you how to use the PWB editor and build a simple single-module program from PWB. Chapter 3, “Managing Multimodule Programs,” expands upon the information you learned in Chapter 2. It teaches you how to build a more complicated program that consists of several modules. You should be able to work through these two chapters in less than three hours.

As you work through these chapters, you may want to refer to Chapter 4, “User Interface Details,” which explains options for starting PWB, briefly describes all of the menu commands, and summarizes how menus and dialog boxes work. The user interface information is presented in one chapter for easy access.

Chapter 5, “Advanced PWB Techniques,” shows how to use the PWB search facilities (including searching with regular expressions), how to use the Source Browser, how to execute functions and macros, and how to write PWB macros.

Chapter 6, “Customizing PWB,” describes how to redefine key assignments, change PWB settings, add commands to the PWB menu, and use the TOOLS.INI initialization file to store startup and configuration information for PWB.

Chapter 7, “PWB Reference,” contains an alphabetical reference to PWB menus, keys, functions, predefined macros, and switches. It contains the essential information you need to know to take the greatest advantage of PWB's richly customizable environment.

## Using the Tutorial

You probably want to get right to work with MASM. The tutorial chapters 2 and 3 can help you become productive very quickly. To get the most out of this material, here are a few recommendations:

- ◆ Follow the steps presented in the tutorial. It is always tempting to explore the system and find out more about the product through independent research. However, just as programming requires an orderly sequence of steps, some aspects of PWB also require sequenced actions.
- ◆ If you complete a step and something seems wrong—for example, if your screen doesn't match what is in the book—back up and try to find out what's wrong. Troubleshooting tips will help you take corrective actions.

- ◆ When working through this tutorial, consider how you might use these techniques in your own work. PWB is like a full tool chest. You probably won't learn (or even want to learn) all of PWB's capabilities right away. But as time goes on, you'll have uses for many of the tools you don't use immediately.

## Conventions in the Tutorial

Procedures described in the course of the tutorial are introduced with headings designated by a triangular symbol. A list of the steps making up the procedure then follows. For example:

➔ **To open a file:**

1. From the File menu, choose Open.  
PWB displays the Open File dialog box.
2. In the File List list box, select the file that you want to open.
3. Choose OK.

In procedures, the heading gives you a capsule summary of what the steps will accomplish. Each numbered step is an action you take to complete the procedure. Some steps are followed by an explanation, an illustration, or both.





---

## CHAPTER 2

# Quick Start

This chapter gets you started with PWB. You'll learn the basics by building and debugging a C-callable routine that generates a 2-byte pseudo-random number.

Some of the source code that you will be using is included with the sample programs shipped with MASM 6.1. If you chose not to install the sample code when you set up MASM, run SETUP to install it (see *Getting Started* for more information).

To start PWB in the Windows operating system for this tutorial, double-click the PWB icon in the MASM group.

In MS-DOS, type

```
PWB
```

at the prompt.

- ➔ **To leave PWB at any time:**
  - From the File menu, choose Exit, or press ALT+F4.

## The PWB Environment

If this is the first time you have used PWB, you see the menu bar, the status bar, and an empty desktop (assuming a standard installation). If you have used PWB before, it opens the file you last worked with.

PWB uses a windowed environment to present information, get information from you, and allow you to edit programs. The environment has the following components:

- ◆ An editor for writing and revising programs
- ◆ A “build engine”—the part of PWB that helps you assemble, link, and execute your programs from within the environment

- ◆ A source-code browser
- ◆ Commands for program execution and debugging
- ◆ The Microsoft Advisor Help system

The browser and the Help system are dynamically loaded extensions to the PWB platform. Microsoft languages and the utilities are also supported in PWB by extensions. Other extensions are available, such as the Microsoft Source Profiler. PWB presents all of these components through menus and dialog boxes.

The following figure shows some parts of the PWB interface.

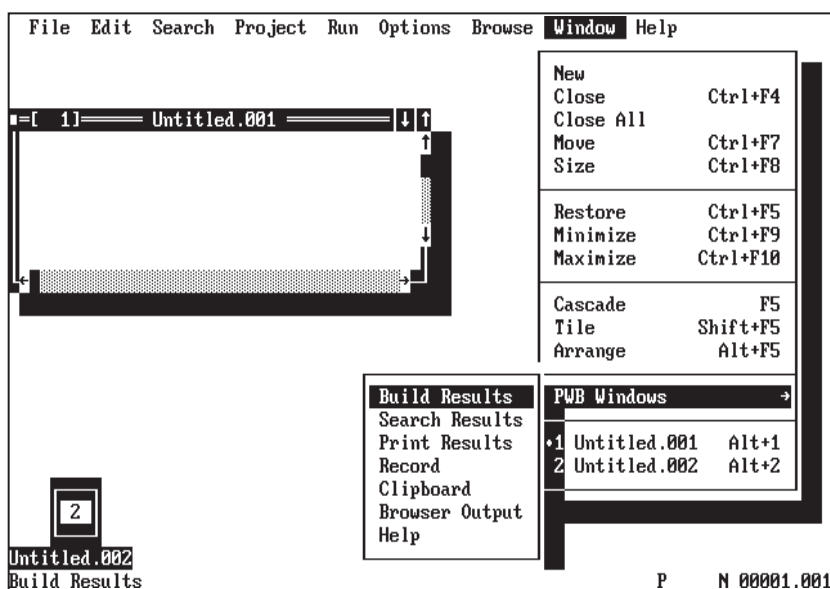

**Figure 2.1** PWB Display

Chapter 4, “User Interface Details,” contains a thorough description of these elements and the rest of the PWB environment. Refer to this chapter when you need specific information about an unfamiliar interface element.

## The Microsoft Advisor

PWB makes programming easier by providing the Microsoft Advisor Help system, which contains comprehensive information about:

- ◆ PWB editing functions
- ◆ PWB advanced features
- ◆ PWB menus and dialog boxes

- ◆ CodeView debugger
- ◆ Intel 80x86 assembly language
- ◆ MASM 6.1 assembler options
- ◆ Microsoft utilities (such as NMAKE, LINK, and so on)

The Advisor provides context-sensitive Help and general Help. Context-sensitive Help provides information about the menu, dialog box, or language element at the cursor. To see context-sensitive Help, you can simply point to an item on the screen and press either the right mouse button or the F1 key. PWB displays a Help window showing the requested information. You can also get context-sensitive Help and more general Help by using the Help menu.

To answer questions of a less specific nature, you can access the Contents screen by choosing Contents from the Help menu or by pressing SHIFT+F1. From the Advisor contents, you can access Help on any other subject in the database.

➔ **To get started using the Microsoft Advisor:**

- From the Help menu, choose the Help on Help command.

Help on Help teaches you how to use the Microsoft Advisor Help system. For more information on using Help, see Chapter 21.

➔ **To close the Help window:**

- Click the upper-left corner of the Help window (the Close box), press ESC, choose Close from the File menu, or press CTRL+F4.

---

**Note** Click the Close box, choose Close from the File menu, or press CTRL+F4 to close any open window in PWB.

---

The following sections explain basic editing procedures. If you're already familiar with these, you can skip to "Opening an Existing File" on page 14.

## Entering Text

In this section, you'll learn basic PWB procedures by entering a simple C-callable assembly-language routine.

➔ **To start a new file:**

1. Move the mouse cursor ("point") to the File menu on the menu bar and click the left button, or press ALT+F from the keyboard.

PWB opens the File menu.

2. Point to the New command and click the left button, or press N to choose New.

PWB opens a window with the title `Untitled.001`.

Pressing the `ALT` key from the keyboard changes focus to the menu bar, and pressing the highlighted key in a menu name opens that menu. Similarly, within a menu, pressing a key highlighted in one of the commands causes that command to be carried out. Using the keyboard, you can also easily move to the beginning of a file by typing `CTRL+HOME`, or to the end of a file by typing `CTRL+END`.

Starting with your cursor in the upper-left corner of the edit window, type the following comment line:

```
; C-CALLABLE PSEUDO-RANDOM NUMBER GENERATOR ROUTINE
```

Your screen should appear as follows:

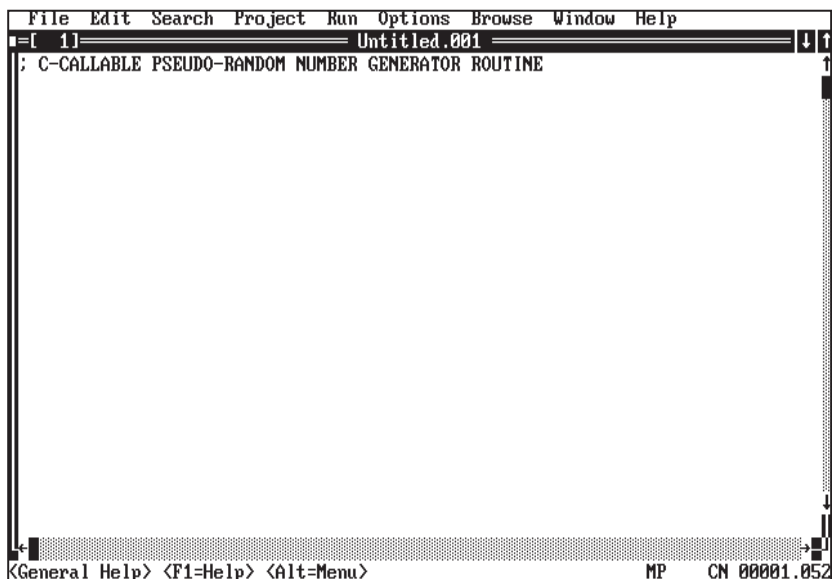

## Saving a File

Now that you've started entering your program, save your work before proceeding.

➔ **To save a file:**

- From the File menu, choose Save, or press `SHIFT+F2`.  
PWB displays the Save As dialog box.

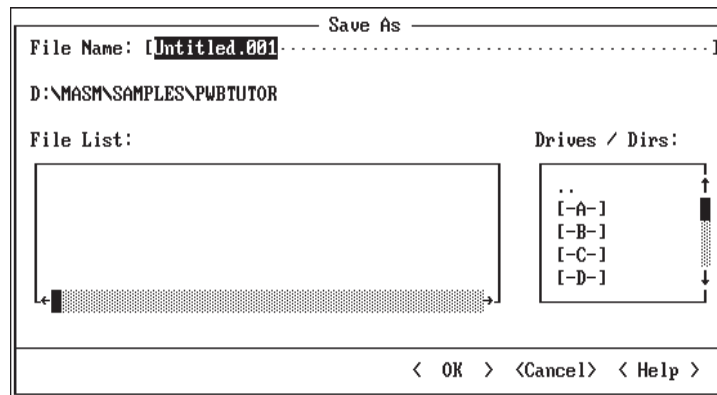

This dialog box has several options that you use to pass information to PWB. PWB indicates the active option—in this case, the File Name text box—by highlighting the area in which you can enter text. For more information about dialog boxes, see Chapter 4, “User Interface Details.”

Because you have not yet saved the file, it still has the name `Untitled.001`. Type `ONEOF.ASM` in the File Name text box. Then click OK or press ENTER to save the file (if you want, you can first select the directory where the file will be saved, using the Drives / Dirs list box).

---

**Note** Now that you have named your file, choosing Save from the File menu does not bring up a dialog box. Your file is immediately saved to disk.

---

## Indenting Text with PWB

Most assembly-language programmers format their code in several text columns (for example, a label column, an instruction column, a parameter column, and a comment column). You can create these columns differently in PWB than in other text editors. In PWB, you can move the cursor (“point”) to any position on the screen and start typing text. PWB will take care of inserting whatever new lines, spaces, or tabs are necessary to place the text in the position you are typing. By setting options, you can determine whether PWB will use spaces or tab characters to create the necessary white space (see “How PWB Handles Tabs” on page 118).

Type the following comment lines to document the routine:

```
;      unsigned int OneOf ( unsigned int range )
;      -----
;      Routine uses a linear congruential method to calculate
;      a pseudo-random number, treats the number as a fraction
;      between 0 and 1, multiplies it times the range,
;      truncates the result to an integer, and returns it.
;
; Algorithm:  a[i] = ( ( a[i-1] * b ) + 1 ) mod m
;            where b = 4961 and m = 2^16
;
OneOf  PROC NEAR C PUBLIC USES bx dx, range:WORD
OneOf  ENDP
```

When you enter assembly-language code, you will often be adding a line indented to the same column as the line above. PWB saves you time by automatically indenting new lines when you press the ENTER key.

- ◆ If there is no line or a blank line immediately below the new line, PWB matches the indentation of the line above it.
- ◆ If there is a line immediately below the new line, PWB matches the indentation of the line below it.

You'll now type some text after the line containing the PROC NEAR directive.

➔ **To insert space for a new line using a mouse:**

1. Position the cursor anywhere past the end of the line containing PROC NEAR. Precise positioning of the cursor is not critical because (by default) PWB trims trailing spaces from the end of your lines.
2. Click the left mouse button.
3. Press ENTER to make a new line.

If you are in overtyping mode, change to insert mode by pressing the INS key. Otherwise, pressing ENTER simply moves the cursor to the beginning of the next line. PWB displays the letter O on the status bar and shows the cursor as an underscore to signal that you are in overtyping mode.

➔ **To insert the new line using the keyboard:**

1. Move the cursor to the line containing the PROC NEAR directive by pressing the UP ARROW key.
2. Press END to move the cursor to the end of the line.
3. Press ENTER to make a new line.

Now type the following lines, using the TAB key to indent and space the instructions:

```

mov     ax, 4961      ; Load the constant into AX and multiply
mul     rndPrev      ; it by the previous value in the series
inc     ax           ; add one to the product
mov     rndPrev, ax  ; and save it, mod 2^16

mov     bx, range    ; Now load the range argument,
mul     bx           ; multiply it times the new number,
mov     ax, dx       ; and return the high 16 bits

```

Your program now looks like this:

```

File Edit Search Project Run Options Browse Window Help
C:\MASM\SAMPLES\PWB\TUTOR\ONEOF.ASM
:
: unsigned int OneOf ( unsigned int range )
:-----
: Routine uses a linear congruential method to calculate
: a pseudo-random number, treats the number as a fraction
: between 0 and 1, multiplies it times the range,
: truncates the result to an integer, and returns it.
:
: Algorithm:  a[i] = ( ( a[i-1] * b ) + 1 ) mod m
:             where b = 4961 and m = 2^16
:
OneOf  PROC NEAR C PUBLIC USES bx dx, range:WORD
mov     ax, 4961      ; Load the constant into AX and multiply
mul     rndPrev      ; it by the previous value in the series
inc     ax           ; add one to the product
mov     rndPrev, ax  ; and save it, mod 2^16

mov     bx, range    ; Now load the range argument
mul     bx           ; and multiply it times the new number,
mov     ax, dx       ; and return the high 16 bits
OneOf  ENDP
:
:-----
<General Help> <F1=Help> <Alt=Menu> N 00001.001

```

Now that you have finished entering the code for the routine, save the file. From the File menu, choose Save, or press SHIFT+F2. Because you have already named and saved the file once before, PWB simply saves it, without bringing up the Save As dialog box.

---

**Note** You can turn on automatic file saving by setting the **Autosave** switch to yes with the Editor Settings command on the Options menu. When **Autosave** is turned on, PWB automatically saves your file before executing certain commands such as running your program or switching to another file. For example, if you run a program that is not yet stabilized, PWB ensures that your file is stored safely in case you have to reboot.

---

## Opening an Existing File

The remainder of this chapter uses a different file, RND.ASM, which you can now open in PWB. This file contains code to let you test the routine you just entered. It has several errors you will correct as you follow the tutorial.

### ➔ To open RND.ASM:

1. From the File menu, choose Open (press ALT+F, O).

PWB displays the Open File dialog box.

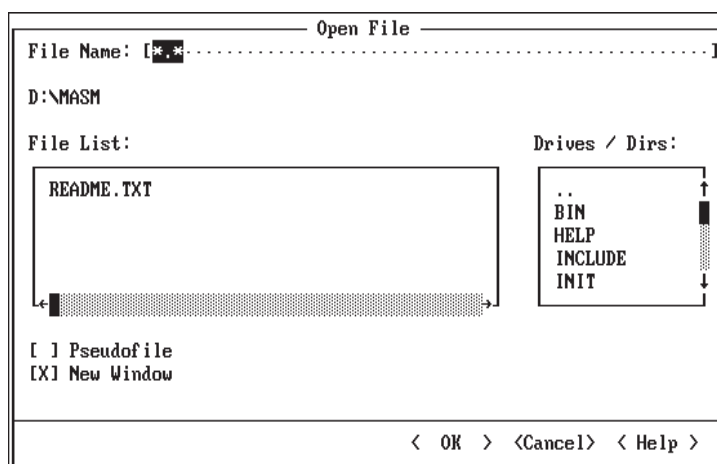

PWB uses \*.\* as the default filename in the File Name text box. This causes PWB to display all files in the current directory in the File List box. If you know the name of the file you want to open, you can replace the \*.\* by typing the filename into the File Name text box.

2. If you are not in the directory or drive where the sample programs are located, press TAB twice to move to the Drives/Dirs box, or click inside it. The example file, RND.ASM, is located in the \SAMPLES\PWBTUTOR subdirectory of your main MASM directory, if you accepted the default directory suggested by SETUP.

The current directory is shown directly beneath the File Name text box. Subdirectories of the current directory are listed in the Drives/Dir box, followed by the available disk drives. Although the box is only large enough to display five entries at a time, you can scroll through the subdirectories or drives to find the one you want by using the DOWN ARROW or PAGE DOWN key, or by using the scroll bar to the right of the box.

A directory entry consisting of two periods (..) indicates the “parent directory” of the one you are currently in. Selecting the .. directory causes you to move one level up your directory tree to the directory immediately above the current



directory. For example, if you are in the directory, C:\MASMSAMPLES, then the .. directory would be C:\MASM. Using the .. entry helps you walk one step at a time along directory “paths.”

You’ll notice that the cursor is a blinking underline. That means that although you have selected the list box, you haven’t yet chosen an item.

- Use the arrow keys to move to the \SAMPLES\PWBTUTOR subdirectory of your main MASM directory.

As you press the arrow keys, you’ll notice that the cursor changes to a bar that highlights the whole selection. This is called the “selection cursor.” The text of the selected item also appears in the File Name box.

- When you have highlighted the drive or directory you want, press ENTER to move there. Using the mouse, you can simply double-click on a directory or drive entry to move to it, without having to go through an intermediate selection step.
- Use the TAB key or mouse to move to the File List box.
- Use the arrow keys to move to RND.ASM, or click on it with the left mouse button.
- When you have highlighted RND.ASM, press ENTER or choose the OK button to accept your selection and open the file. Just as with the directory or drive entries, you can simply double-click on the filename to open it, bypassing the selection step.

PWB opens RND.ASM for editing.

```

File Edit Search Project Run Options Browse Window Help
[ 1] D:\MASM\SAMPLES\PWBTUTOR\ONEOF.ASM
[ 2] D:\MASM\SAMPLES\PWBTUTOR\RND.ASM
.NOLIST
; This source file contains a C-callable routine designed to generate
; unsigned pseudo-random numbers between 0 and any number up to 65,535
; (up to 16 bits long). It takes an argument specifying the upper end
; of the desired range. The rest of the file contains code used to
; test the routine by writing its output to the standard output device.
.LIST
      PAGE      55,132
      TITLE    Random number routine: OneOf( range ), with test code
      .MODEL   small, c
      .DOSSEG
      .186

OneOf  PROTO   range:WORD
seedr  PROTO
atoui  PROTO
uitoa  PROTO

.STACK
<F1=Help> <Alt=Menu> <F6=Window> CN 00001.001

```

## Copying, Pasting, and Deleting Text

The RND.ASM code contains a placeholder routine named OneOf, which returns 0. You can now delete it and replace it with the random number routine that you created in the previous section of this tutorial.

You have already typed in and saved the OneOf routine in a different file. Rather than type it over again, you can copy and paste it using PWB's clipboard (a temporary storage place for text). To do this, open the Window menu and choose the ONEOF.ASM window (if you no longer have it open, you will need to go back to the directory in which you saved it and open it using the Open command on the File menu).

Next, to copy the routine most conveniently, you will change the way text is selected. Three selection modes are available on the Edit menu:

- ◆ Stream mode—by default, the editor starts in stream selection mode, which allows selection to begin at any point, and selects all characters in a stream between the beginning and end positions of the cursor.
- ◆ Line mode—selects complete lines of text, starting with the entire line on which the cursor begins, and ending with the entire line on which it ends.
- ◆ Box mode—allows you to select a rectangular section of text, one corner of which is the starting position of the cursor, and the opposite corner of which is the ending position of the cursor.

The currently active selection mode is marked with a dot on the Edit menu. Clicking on a mode selects it. You can also change modes while selecting text. Just select text by clicking the left mouse button and dragging the mouse. Then, without releasing the left mouse button, press the right mouse button to toggle among the selection modes.

In this case, line selection mode is the most convenient.

➔ **To change the selection mode:**

- From the Edit menu, choose Line Mode.

Next, place the cursor on the top line of text for the routine:

```
;      unsigned int OneOf ( unsigned int range )
```

➔ **To select lines of text using the keyboard:**

- Press SHIFT+DOWN ARROW until the cursor is on the line containing ENDP.

→ **To select lines of text using the mouse:**

- Hold down the left mouse button and drag the cursor to the line containing ENDP.

→ **To copy and paste the text that has been selected:**

1. From the Edit menu, choose Copy. This action places the section of text that has been selected into the clipboard. You can also invoke the copy command using the shortcut key combination CTRL+INS.
2. From the Window menu, choose the RND . ASM window.
3. Go to the place where you want to insert the routine (line 51). Press ALT+A, type 51, then press CTRL+M to jump to line 51.

This sequence of keystrokes is pronounced “Arg 51 Mark.” The PWB function **Arg** begins an argument (51) that is passed to the **Mark** function. When you pass a number to **Mark**, PWB moves the cursor to that line.

You can also do this from the menu by typing the line number in the Goto Mark dialog box from the Search menu.

The cursor is at the beginning of line 51, exactly where you want to insert the new routine.

4. From the Edit menu, choose Paste, or use the SHIFT+INS shortcut keystroke to paste the contents of the clipboard into that location.

→ **To delete the old placeholder routine:**

1. Use the PAGE DOWN key and arrow keys or mouse to move to the first line of the placeholder routine, just below the ENDP line of the inserted routine.
2. Select the six lines of the old routine, using SHIFT+DOWN ARROW or by selecting with the mouse.
3. From the Edit menu, choose Delete, or press DEL.

The selected section is deleted.

---

**Important** If you select an area of text and then type something or otherwise insert text, PWB *replaces* the selected text (deletes it and substitutes what you are typing or inserting), without saving it on the clipboard. You can recover the text by choosing Undo at once from the Edit menu. In the example above, if you had selected the six lines of old routine before pasting in the new routine, those lines would have been deleted and replaced by the paste operation.

---

You have inserted the new routine into RND.ASM. Save the file by choosing Save from the File menu.

## Single-Module Builds

The next step is to assemble and link the RND program to see if it works. Assembling and linking the source files is called “building the project.” It results in an executable file. A project build can also:

- ◆ Create and update the browser database.
- ◆ Create a Windows-based dynamic-link library (DLL).
- ◆ Build a library of routines.

## Setting Build Options

Before you build a program, you must tell PWB what kind of file to create by using the commands on the Options menu. Use the commands from the Options menu to specify:

- ◆ The run-time support for your program. This is important for mixed-language program development, where you have some source files in assembler and some in another language. With Basic, for example, the run-time support must be Basic’s run-time support.

The run-time support you choose determines the run-time libraries that are used and the types of target environments that can be supported.

- ◆ Project template. The template describes in detail how PWB is to build a project for a specific type of file (.EXE, .COM, .DLL, .LIB) and the operating environment for the target file (MS-DOS, the Windows operating system, and so on).
- ◆ Either a debug or release build. Debug options normally specify the inclusion of CodeView debugging information, where release options do not. You may want to generate a different listing file for a debug build than for a release build, or you may not want any listing file for one type of build or the other.
- ◆ A build directory. PWB builds your object and executable files in your current directory unless you specify otherwise. (This option is reserved for projects that use explicit project files, which are described in Chapter 3.)

➔ **To set the project template for RND.ASM:**

1. From the Options menu, choose Set Project Template from the Project Templates cascaded menu.

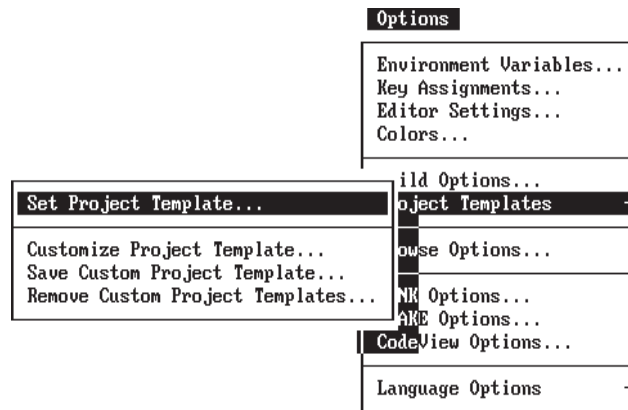

Note that the actual order of the menu items may differ from the illustration because PWB's extensions can be loaded in any order.

2. PWB displays the Set Project Template dialog box.

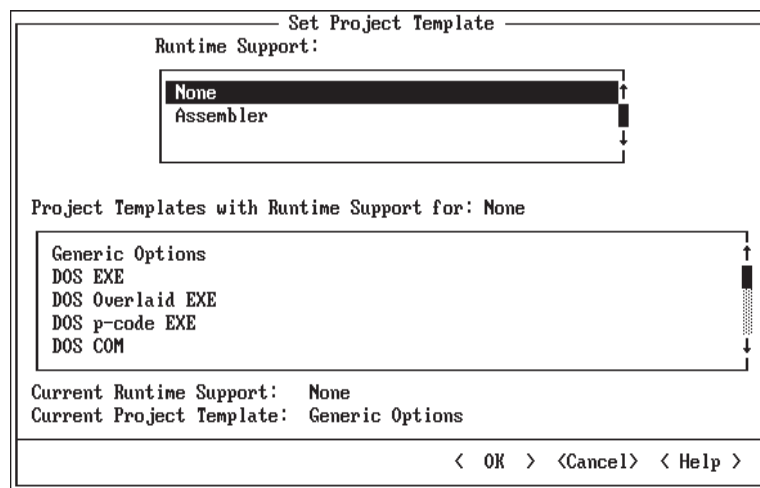

This dialog box typically has the entries `None` and `Assembler` in the Runtime Support list box. If you have installed other languages, their names appear as well.

Since the RND program does not require run-time support, leave `None` selected.

3. Move to the Project Templates list box by clicking in the box, pressing the TAB key the appropriate number of times, or by pressing ALT+T.
4. Select `DOS EXE`.
5. Choose the OK button to set the new project template.

→ **To set the build options for RND.ASM:**

1. From the Options menu, choose Build Options.  
PWB displays the Build Options dialog box.

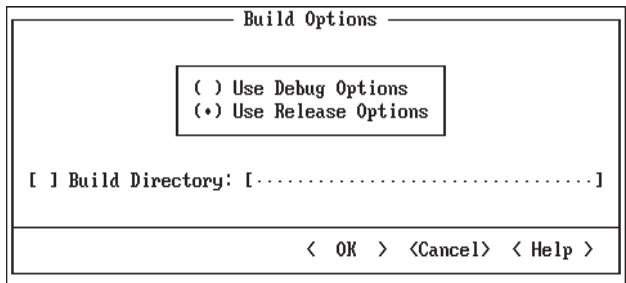

2. Turn on Use Debug Options by choosing the Option button or by pressing ALT+D.  
This option tells PWB that you are building a debugging version of the program. PWB uses debug options when you build or rebuild until you use the Build Options dialog box to choose Use Release Options.
3. Choose the OK button.
4. From the Options menu, choose Languages Options, then choose MASM options from the secondary menu.  
PWB displays the Macro Assembler Global Options dialog box.
5. Choose Set Debug Options.  
PWB displays the Macro Assembler Debug Options dialog box.  
In the Debug Information box, CodeView should already be selected, indicating that the assembler will generate the information that CodeView needs to correlate assembled code with source code.
6. Select Generate Listing File and Include Instruction Timings. This causes the assembler to create a listing file showing you exactly how it assembled your program, and to include in the listing how many clock cycles each instruction will take to execute.
7. Choose the OK button twice.

PWB saves all the options that you specify. You don't have to respecify them each time you work on your project.

The following illustration shows the three sets of options that PWB maintains for each project. Global options are used for every build. Debug options are used when Use Debug Options is turned on in the Build Options dialog box. Release options are used when Use Release Options is turned on.

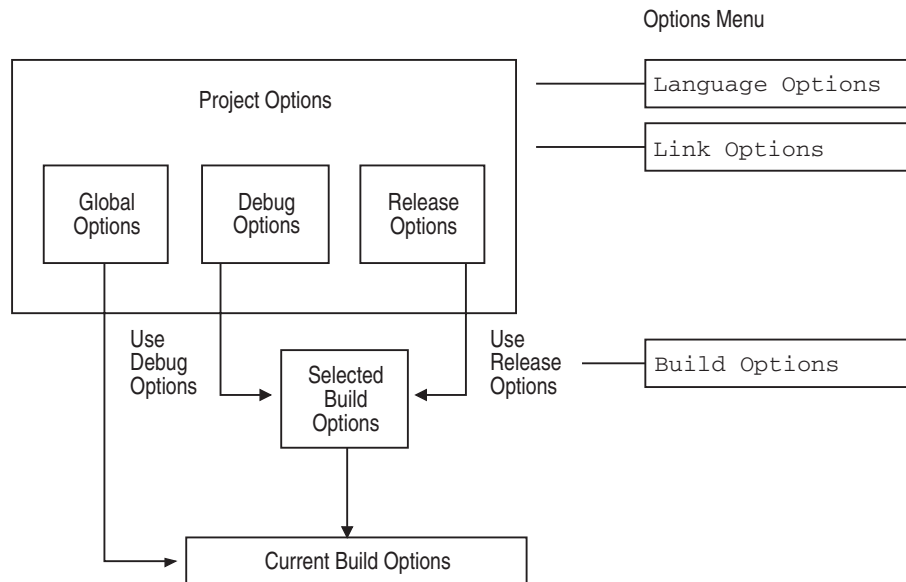

You can set assembler and linker options for both types of builds (debug and release) by using the Language Options commands and the LINK Options command. The Build Options command then determines which type of build, using which set of options, is actually performed when you assemble a file or rebuild the project.

Global options, on the other hand, typically include settings for warning level, memory model, and language variant. These are options that do not change between debug and release versions of a project.

## Setting Other Options

The Options menu also contains commands that allow you to describe the desired project build more completely. You don't need to change most of these options to build RND.ASM because the default values supplied by the template will work well.

The Options menu contains the following commands:

- ◆ MASM Options in the Language Options cascaded menu. These commands let you specify assembler options specific to debug and release builds, and general options common to both types of builds. Using the MASM Global Options dialog box, you can specify memory model, warning level, and so on.

If you have more languages installed, their Compiler Options commands also appear in the Languages Options cascaded menu.

- ◆ **LINK Options.** This command parallels the Compiler Options commands. You can specify options specific to debug or release builds and general options common to both debug and release builds.  
Use LINK Options to specify items such as stack size and additional libraries. You can also select different libraries for debug and release builds. This is handy if you have special libraries for debugging and fast libraries for release builds.
- ◆ **NMAKE Options.** This command lets you specify NMAKE command-line options for all builds. This option is particularly useful if you have an existing makefile that was not created by PWB or if you have modified your PWB project makefile. For more information about these subjects, see “Using a Non-PWB Makefile” on page 55.
- ◆ **CodeView Options.** This command allows you to set options for the CodeView debugger.

## Building the Program

Now that you’ve set your options, you can build the program. Note that the sample program contains intentional errors that you will correct.

➔ **To start the project build:**

1. From the Project menu, choose Build.  
PWB tells you that your build options have changed and asks if you want to Rebuild All.
2. Choose Yes to rebuild your entire project.

After the build is completed, PWB displays the following dialog box:

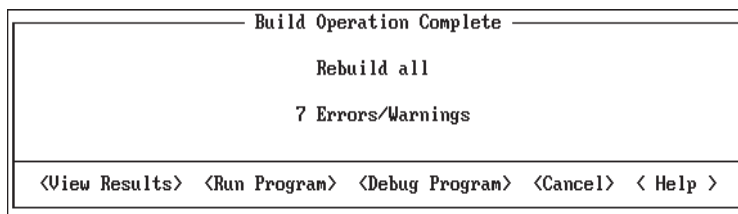

You can choose one of several actions in this dialog box:

- ◆ View the complete results of the build by opening the Build Results window.
- ◆ Run the program if building in MS-DOS. You can run an MS-DOS program right away if the build succeeds. If the build fails, you should fix the errors before you attempt to run the program.



To run a successfully built Windows-based program, you must be running under the Windows operating system, and have started the WXServer program *before* you start PWB.

- ◆ Debug the program if building in MS-DOS. If the build succeeds but you already know the program is not producing the intended results, you can debug your MS-DOS program using CodeView.

To debug a Windows-based program, you should be running under the Windows operating system, and already have the WXServer running when you start PWB or CodeView.

- ◆ Get Help by choosing the Help button or by pressing F1 (as in every PWB dialog box).
- ◆ Cancel the dialog box. This returns you to normal editing.

Choose View Results to close the dialog box (press ENTER). PWB displays the results of the build so that you can review the build messages or step through them to view the location of each error. The next section describes how to do this.

## Fixing Build Errors

For each build, PWB keeps a complete list of build errors and messages in the Build Results window. The RND.ASM program that you just built contains several errors that you'll identify and fix in this section.

If you want to examine build errors in a specific order, you can do so in the Build Results window by placing the cursor on whatever error you wish to examine, and selecting Goto Error from the Project menu. PWB opens a window onto the appropriate source file and places the cursor on the line at which that error was recognized. When you are finished with each error, selecting the Build Results window from the Window menu will return you to the Build Results window.

In many cases, however, you will want to work through the errors one after another. This is the easiest method for fixing the build errors in RND.ASM.

### → To fix errors one after another:

1. From the Project menu, choose Next Error, or press SHIFT+F3.

PWB positions the cursor on the location of the first error or warning in your program. In this case, a comma is missing after the 10 at the end of the first line of the `banr2` data declaration.

```

File Edit Search Project Run Options Browse Window Help
[ 1] Build Results
=[ 2] D:\MASM61\CODE\RND.ASM
lbanr EQU sizeof banr
banr2 BYTE 13, 10
      (80 numbers in each series)"
lbanr2 EQU sizeof banr2
prompt BYTE 13, 10, 13, 10,
      "Please enter a range (0 - 65,535): "
lprompt EQU sizeof prompt
isrng BYTE 13, 10,
      "Is:12345678 the correct range? If so, press 'Y': "
lisrng EQU sizeof isrng
again BYTE 13, 10,
      "Press "Esc" to quit, any other key to continue ", 13, 10
lagain EQU sizeof again
ALIGN 2
RND.ASM(31): error A2008: syntax error : (80 numbers in each series)
<F1=Help> <Error Help> <F6=Window> N 00031.017

```

2. Correct the first error by inserting a comma immediately after the 10.
3. From the Project menu, choose Next Error, or press SHIFT+F3.

PWB moves the cursor to the location of the second error. Here, "Esc" in the string on the line below the cursor is enclosed in double quotes, and the string itself is also enclosed in double quotes. As a result, the assembler interprets the first set of quotes around Esc as the end of the string, and then does not recognize Esc as a valid instruction or directive. This can be fixed by substituting a pair of single quotes for the pair of double quotes either around the string or around Esc.

4. Fix the error by changing the double quotes ( " ") around Esc to single quotes ( ' ' ).

Because of this error, the data symbol **again** was not defined during the first assembly pass, which also meant that the constant **lagain** could not be evaluated. As a result, two more errors were generated, which can now be ignored.

5. From the Project menu, choose Next Error, or press SHIFT+F3.

PWB positions the cursor on the location of the third error, a simple typographical error where the **mov** instruction was spelled "mob."

6. Correct the third error by replacing the "b" in mob with a "v."

Now that all the build errors in RND.ASM have been corrected, save the file by choosing Save from the File menu or by pressing SHIFT+F2.

## Running the Program

The next step is to build and run the program.

→ **To run the program:**

1. From the Run menu, choose Execute (be sure that you have saved RND.ASM first).

PWB detects that you've changed the source and displays a dialog box with the following options:

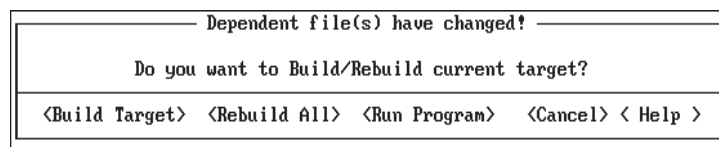

2. Choose Build Target to build the program.

When the build completes, PWB displays the following dialog box:

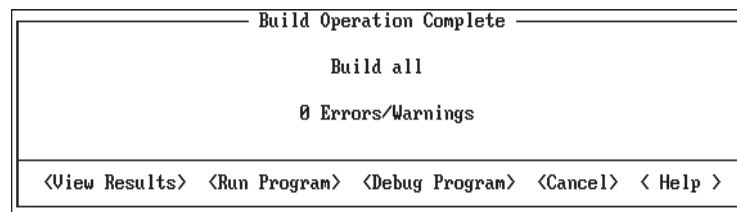

3. Choose Run Program to run the finished program.

When you run it, the RND program will start by asking you to supply a range value between 1 and 65,535. Type 1234 and press ENTER. The program will then ask you to confirm that 1,234 is indeed the correct range. When you type *y*, the program is supposed to display a list of random numbers within that range. Instead, however, the program restarts when you type *y*. Something is wrong.

To get out of the program and back to PWB, press CTRL+C (in the case of this particular program, you can also use the ESC key to exit when the program asks for confirmation of a range value). Before blanking your program's output, PWB will display the message, "Strike any key to continue..." so that you can examine the final state of the screen.

The following sections describe the process of debugging using the Microsoft CodeView debugger. If you're already familiar with CodeView, skip to Chapter 3, "Managing a Multimodule Program."

## Debugging the Program

PWB integrates several Microsoft tools to produce a complete development environment. Among those tools are NMAKE, a program maintenance utility, and CodeView, a symbolic debugger. Whenever you build programs using PWB, PWB in turn invokes NMAKE to manage the build process. In the same way, PWB can serve as a gateway to CodeView when you need to debug a program you have built.

Earlier, you chose Use Debug Options in the Build Options dialog box. A debug build typically includes the assembler options that generate CodeView information. Therefore, the program is ready to debug with the CodeView debugger.

## Using CodeView to Isolate an Error

In addition to the typographical errors that you just corrected, RND.ASM contains a logical error which will prevent it from running properly. You can use CodeView to isolate this error.

### → To start CodeView:

- From the Run menu, choose Debug.

If anything in your program is out of date, PWB asks if you want to build or rebuild the current target. If you modified the source file in any way, PWB considers it out of date relative to the executable file that you built earlier. If this happens, build the program and choose Debug from the Run menu.

CodeView now starts, displaying three windows on its main debugging screen.

The screenshot shows the CodeView debugger interface with three windows:

- locals**: An empty window for local variables.
- source1 CS:IP RND.ASM**: A window displaying assembly code for RND.ASM. The code is as follows:
 

```

72:  OneOf  ENDP
73:
74:      .STARTUP
75:
76:      ; Seed the random number generator with a "random" value
77:      call  seedr
78:
79:      ; Display 1st Banner line
80:      mov   ah, 040h      ; DOS function: Write to file or device
81:      mov   bx, 1         ; Handle = Standard Output
82:      mov   cx, lbanr     ; Number of bytes to write
      
```
- command**: A window for entering commands, currently showing a prompt '>'. Below the window are keyboard shortcuts: <F8=Trace> <F10=Step> <F5=Go> <F3=S1 Fmt> and a DEC button.

The first thing to do is set up the CodeView screen so that it best suits your way of working. When you leave CodeView, your setup will be saved in CURRENT.STS. The next time you use CodeView, that setup will be restored when the program starts.

The right screen layout depends a lot on your work style, and on the project you are working on. In this case, many of CodeView's more advanced features will not be necessary, so we will set up a simple screen.

By default, three windows are initially displayed: "locals," "source1," and "command." Close the locals window, since it will not be needed in debugging RND, open a register window and a memory window, and arrange the windows in the screen.

The screenshot shows the CodeView debugger interface with three windows open:

- memory1 b DS:0**: Shows memory addresses 37AB:0000 to 37AB:001A with their corresponding hex values and ASCII characters.
- source1 CS:IP RND.ASM**: Shows assembly code starting at address 74: with instructions like MOV AX,37D2, MOV DS,AX, MOV BX,SS, SUB BX,AX, SHL BX,04, MOV SS,AX, and ADD SP,BX. A comment at 76: reads "; Seed the random generator with a 'random' value" and a call instruction at 77: reads "call seedr".
- reg**: Shows the current state of registers: AX = 0000, BX = 0000, CX = 0000, DX = 0000, SP = 0400, BP = 0000, SI = 0000, DI = 0000, DS = 37AB, ES = 37AB, SS = 37E6, CS = 37BB, IP = 0028, FL = 0200.

At the bottom, there is a command window with a prompt ">" and a status bar with keyboard shortcuts: <F8=Trace> <F10=Step> <F5=Go> <F3=S1 Fmt> <Sh+F3=M1 Fmt> DEC.

- ➔ **To close a window using the mouse:**
  - Click the upper left corner of the window.
- ➔ **To close a window using the keyboard:**
  - Use the F6 key to move into the window that you want to close. Choose Close from the Windows menu, or press CTRL+F4.
- ➔ **To open the Register and Memory windows:**

1. From the Windows menu, choose Register, or press ALT+7.

The Register window displays the contents of the processor's registers, either in "Native" (8086) mode, or in "32-bit" (80386-80486) mode.

2. At the bottom of the Options menu, click Native if it is not already selected.
3. Choose Memory 1 from the Windows menu, or press ALT+F5.

Memory windows display the contents of a specified block of memory, so that you can watch changes as your program runs.

→ **To move and size a window using the mouse:**

1. To move a window, place the cursor on its top line, not in a corner. Then drag the window to a new location.
2. To size a window, move the cursor to the lower right corner of the window. Then drag the corner to change the window's size.

→ **To move and size a window using the keyboard:**

1. Using the F6 key, shift focus to the window you want to size.
2. Choose Move or Size from the Windows menu.
3. Use the arrow keys to move or size the window.
4. Press ENTER when you are finished.

When you have positioned and sized the windows to your satisfaction, set the source window to show both your source text and the actual instructions assembled by MASM, and set the memory window to stay fully up to date as the program executes.

→ **To display mixed source and assembler output:**

1. From the Options menu, choose Source1 Window.  
CodeView displays the Source1 Window Options dialog box.
2. In the Display box, choose Mixed Source and Assembly.
3. Choose OK.

→ **To set the Memory1 window to be updated frequently:**

1. From the Options menu, choose Memory1 Window.  
CodeView displays the Memory1 Window Options dialog box.
2. Select the "Re-evaluate expression always (live)" check box.
3. Choose the OK button.

## Working Through a Program to Debug it

CodeView has placed you at the program's starting point. The registers are as they would be at that point, and the memory window shows whatever the DS register is

pointing to. The instructions that appear at the top of the source window have been created by the `.STARTUP` directive, as you can see if you scroll up a few lines.

CodeView provides various ways to control and examine the execution of a program. The “Step” command (F10 key) executes the next instruction in the program, and if that instruction is a call, executes the entire called code up through the return. “Trace” (F8 key), on the other hand, jumps to the called code and traces through it too, one instruction at a time. You can also run the program up to a given point, or set breakpoints at several points. With RND, we will only need to use a few of the possible debugging tools.

➔ **To Step through the program:**

- Use the F10 key to step through the first couple of instructions of the `.STARTUP` code.

You will notice that as each instruction is executed, CodeView briefly displays the program output screen, and updates the Register window to show changes in the registers. As the DS register is loaded, the Memory window displays the data segment of the RND program.

Stepping is a slow way to move through the program. In many cases, as with RND, you will want to move quickly to the point where the program failed, to see what the matter was. In RND, everything seemed to be working correctly until you entered `y` to confirm the range.

➔ **To run a program up to a given place:**

1. Scroll through the code to the comment line:

```
    ;           Read in a character from the keyboard
```

Three lines below the comment is a **cmp** instruction.

2. Place the cursor on the line containing the **cmp** instruction, either by using the arrow keys or the mouse.





So far, so good: the program continues to run as expected.

- Now press F10 to execute the call itself.

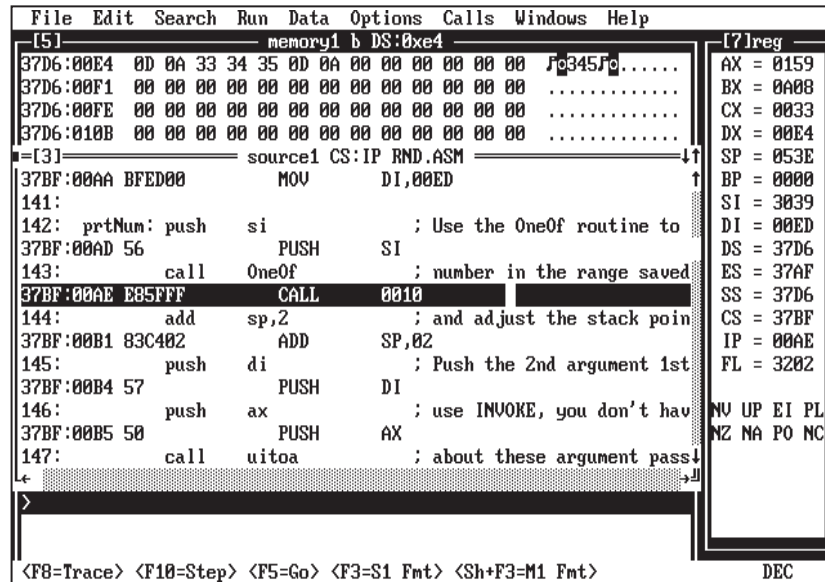

The program now erroneously starts over. We now know that the problem must be located in the OneOf routine.

- Press CTRL+C, then ENTER to get out of the program.
- Choose Restart from the Run menu to return to the beginning of the program.
- As you did before, scroll down to where OneOf is called and execute the program up to just before the call.
- This time, use F8 to trace through the call.

You will notice that CodeView now shifts into the called routine, allowing you to step through the OneOf code instruction by instruction.

- Step or trace through the OneOf routine, using F10 or F8, and look for the problem.

You will discover a simple error of omission: the routine has no **ret** instruction at the end. As a result, execution continues into the succeeding code, which happens to be the .STARTUP code.

Having found the problem, you can leave CodeView and return to PWB.

- From the File menu, select Exit.

CodeView closes, saving your settings for next session.

13. From PWB, insert a new line in the RND.ASM file just before the ENDP line of the OneOf routine.
14. Type a **ret** instruction there.

```

File Edit Search Project Run Options Browse Window Help
D:\MASM\SAMPLES\PUBTUTOR\RND.ASM
;
; argument, truncates the resulting product to an integer,
; and returns it.
;
; Algorithm:  a[i] = ( ( a[i-1] * b ) + 1 ) mod m
;             where b = 4961 and m = 2^16
;
OneOf  PROC NEAR C PUBLIC USES bx dx, range:WORD
        mov     ax, rndPrev      ; Load the previous value in the series
        mov     bx, 4961         ; and multiply it by the constant
        mul     bx
        inc     ax               ; add one to the product
        mov     rndPrev, ax      ; and save it, mod 2^16

        mov     bx, range       ; Now load the range argument,
        mul     bx               ; multiply it times the new number
        mov     ax, dx           ; and return the high 16 bits of the product
        ret

OneOf  ENDP

        .STARTUP
  
```

<General Help> <F1=Help> <Alt=Menu> N 00072.012

15. Save the corrected file by choosing Save from the File menu, or by pressing SHIFT+F2.
16. Select Execute from the Run menu to rebuild the program and try it again.

This time, it should work without problems.

## Examining Memory in the Memory Window

In addition to being able to watch the register contents change as your code runs, CodeView lets you see what happens to locations in memory. For example, you may have noticed that `OFFSET lnBuf` was assembled as hex `E4`. By setting the memory window at that address, you can watch what happens in the `lnBuf` buffer as the program formats a line of output. One way to reach that address, since it is fairly close, is to scroll in the memory window until you get to it. However, this is often impractical.

### ➤ To set the address in the Memory Window:

1. From the Options menu, select Memory1 Window.
2. In place of `DS:0` in the Address Expression field of the Memory1 Window Options dialog box, type `DS:0x00e4`.

Now, you can step through cycles of a formatting loop and watch the buffer change.

→ **To step through a formatting loop in RND.EXE:**

1. In the source window, scroll to the instruction `dec bl` around line 150, which completes a formatting cycle for a random number.
2. Press F7 or click in that line with the right mouse button.

If you know for sure that `dec bl` is on line 150, you can move to the Command window and type `g @150` followed by the ENTER key. This instructs CodeView to execute the program up through line 150 in the source file.

The screenshot shows the CodeView interface with three main windows:

- Memory Window (top):** Shows memory addresses and their contents. The address `37D2:00E4` contains the value `3,377`. The address `37D2:00F1` contains `4,396`. The address `37D2:00FE` contains `10,014`.
- Source Window (middle):** Shows the assembly code for `RND.ASM`. Line 150 is highlighted: `150: dec bl ; Decrement the number count`. Other visible lines include `151: jnz prtNum ; and go on until finished.`, `153: push bx ; If it's time to print a l`, `154: mov ah, 040h ; DOS function: Write to fi`, and `155: mov bx, 1`.
- Command Window (bottom):** Shows the command `>g @150` entered, with a prompt `>` below it.

At the bottom of the window, there are keyboard shortcuts: `<F8=Trace> <F10=Step> <F5=Go> <F3=S1 Fmt> <Sh+F3=M1 Fmt>` and the text `DEC`.

3. While watching the memory window, press F7 again, or click the `dec bl` instruction again with the right mouse button.

As the loop executes again, you can see the memory area change to reflect the new value being formatted into `lnBuf`.

→ **To switch from CodeView back to PWB:**

- Choose Exit from the CodeView File menu.

## Where to Go from Here

Now that you've created, built, and debugged a simple program, you've begun to discover the power of PWB. Chapter 3, "Managing Multimodule Programs," describes how to create and manage projects with more than one source file.



## CHAPTER 3

## Managing Multimodule Programs

This chapter expands on the work you did in Chapter 2 and explains how to build and maintain multimodule programs using PWB's integrated project-management facilities. PWB offers an efficient way to manage complex projects. You organize and build your project entirely within PWB, using convenient menus and dialog boxes instead of makefiles or batch files.

PWB stores the information needed to build and manage your program in two files, the project makefile and the project status file. These are called the "project." When you open the project, PWB automatically configures itself to build your program. To move from one project to another, you close one project and open another.

### Multimodule Program Example

In this chapter, you'll learn to set up a multimodule project in PWB by building SHOW.EXE, a three-module program. The SHOW program displays text files on character-based screens with MS-DOS.

The following modules make up SHOW.EXE:

<b>Module</b>	<b>Function</b>
SHOW.ASM	Program driver; contains .STARTUP entry point, and calls all other procedures.
PAGER.ASM	Contains procedures for paging through a file and writing text to the screen buffer
SHOWUTIL.ASM	Contains miscellaneous procedures.

The program also contains a common header file SHOW.INC in addition to these three source modules. Figure 3.1 shows the components of SHOW and how they combine to build the executable file.

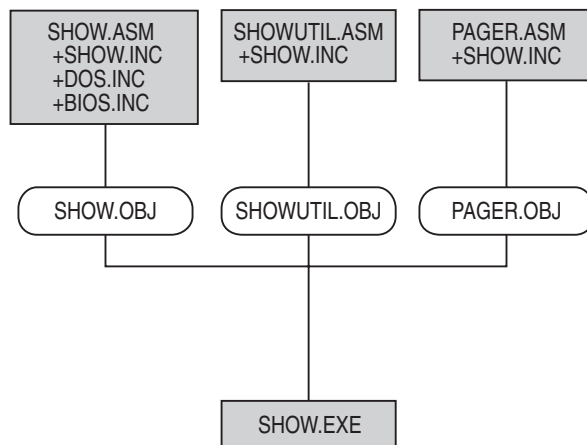

**Figure 3.1 The SHOW Project**

To build SHOW.EXE, you need to assemble the three source files and link them together, having specified the assembler and link options that will produce the kind of file you are trying to make. All this build information is stored in the SHOW project make and status files.

## Opening the Project

Start by opening the SHOW project. (If you have not started PWB, do so now.)

### ➤ To create a project:

1. From the Project menu, choose New Project.  
PWB displays the New Project dialog box.

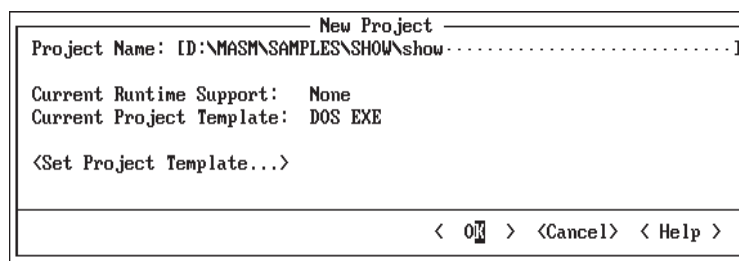

2. Type show in the Project Name text box.
3. Choose Set Project Template.  
PWB displays the Set Project Template dialog box.
4. Select the following options:

- ◆ Runtime Support: None.
- ◆ Project Template: DOS EXE.

At this point, the Set Project Template dialog box should appear as follows:

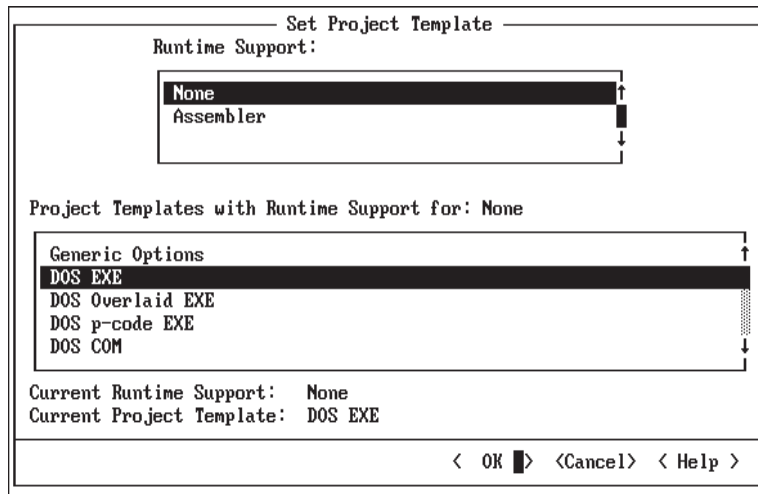

This initial specification tells PWB what kind of executable file you intend to build, and is saved as part of the project.

5. Choose OK to return to the New Project dialog box.

In this case, a project makefile, SHOW.MAK, already exists. Since PWB would ordinarily create and save a new makefile at this point, you are now asked whether you want to overwrite the existing file.

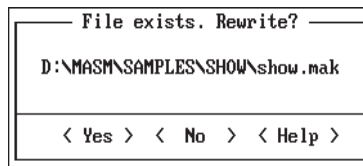

6. Choose Yes to overwrite the existing file.

PWB saves the new SHOW.MAK and returns to the New Project dialog box.

7. Choose OK.

PWB now displays the Edit Project dialog box so that you can add files to your new project.

The next section describes the types of files that can be added to the project. The tutorial then continues by listing the example files to add to the list.

## Contents of a Project

A project file list can contain the following files:

- ◆ Source code files (.ASM).
- ◆ Object files (.OBJ) in special cases.
- ◆ Library files (.LIB) for libraries that change.
- ◆ Module-definition files (.DEF) for DLLs.
- ◆ Resource-assembler source files (.RC) for Microsoft Windows-based programs.

These file types are all that are needed to create most MS-DOS and Windows-based applications. Include files, such as SHOW.INC, need not be listed because PWB automatically adds them when it scans your source files for dependencies.

When you select assembler run-time support with a Windows-based project template in the Set Project Template dialog box, PWB automatically specifies standard library files such as LIBW.LIB. Therefore, you need not add standard library files to the project list.

### ➔ To add the SHOW files to your project:

1. Choose the files you want to add to the project from the File List box. In this case, you'll add SHOW.ASM, PAGER.ASM, and SHOWUTIL.ASM. These files are located in the \MASM\SAMPLES\SHOW directory. If you installed Microsoft MASM 6.1 in a directory other than MASM, adjust the path accordingly.

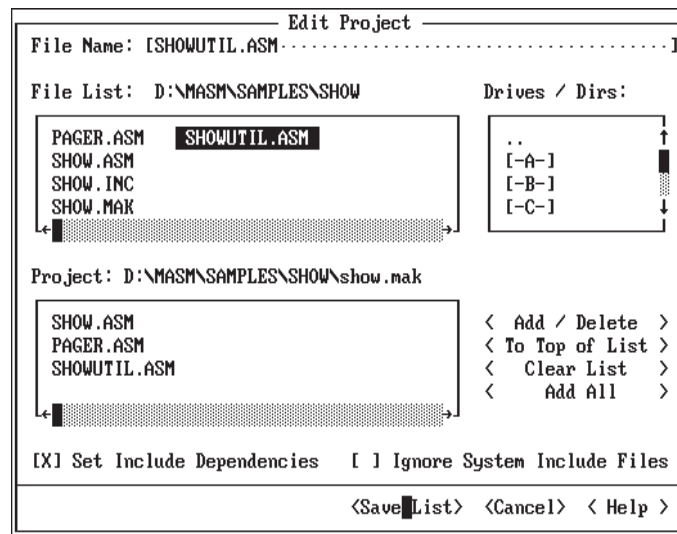



You can scroll the File List box by clicking the scroll bars or by pressing the arrow keys.

2. For each file, select it and choose Add / Delete to add the file to the Project list box. Or, you can double-click a file to add or remove it from the list. To add all three files at once, you can type \* .ASM in the File Name field, press ENTER, and then choose Add All.
3. Choose Save List when you have added all three files.

PWB uses the rules in the project template along with the list of files that you just specified to scan the sources for include dependencies and to create the project makefile. This process is described in the next section.

Now your project completely describes what you want to build (the project template), the component source files, and the commands used to build the project.

## Dependencies in a Project

When you save the project, PWB generates a makefile from the project template, files, and options you specified. This file also contains a list of instructions that are interpreted by NMAKE. In addition, PWB generates the project status file, which saves the project template, the editor state, and the build environment for the project. For more information on the project status file, see “Project Status Files” on page 129.

When you build the project, NMAKE examines the build rules in the project makefile. These are rules that specify targets (such as an object or an executable file) and the commands required to build them. For example, a rule for making an .OBJ file from an .ASM file can be expressed as follows:

```
.asm.obj :  
    ML /c $<
```

To reduce the amount of time builds take, NMAKE assembles or links only the targets that are out-of-date with respect to their corresponding source file. This process is simple if there is a one-to-one correspondence between sources and targets. However, many programs use the INCLUDE directive to include files containing common equates, macros, and other program text. The object files must be made dependent not only on the source file but also on the files that are used by the source file.

You don't need to add include (.INC) files to your project. When you save the project, PWB scans your source files looking for INCLUDE directives and builds dependencies on these files. NMAKE will thereafter recompile a source file if you change a file that it includes.

## Building a Multimodule Program

Now that the project files are complete, you can build the program in the same way you built the single-module program.

➔ **To build a multimodule program:**

1. You are starting a new project, so you should use debug options for the initial builds. Choose the Use Debug Options button in the Build Options dialog box.
2. From the Project menu, choose Build.  
PWB displays a dialog box to inform you that build information has changed because you altered the build options.
3. Choose Yes to rebuild your entire project.

As the program is built, PWB shows status messages about the progress of the build. When the build completes, a dialog box displays a summary of any errors encountered during the build process.

---

**Note** The Next Error command on the Project menu works the same for a multimodule build as for a single-module build. Because errors in a multimodule build can occur in different files, PWB automatically switches to the file that contains the error.

---

In some cases, you will want to force a complete rebuild of your project by choosing Rebuild All from the Project menu. The difference between Build and Rebuild All is that Build compiles and links only out-of-date targets and Rebuild All compiles all targets, regardless of whether they are current.

## Running the Program

Now that your program is built, you can test it from PWB.

➔ **To run SHOW:**

1. From the Run menu, choose Program Arguments.
2. Type the name of a text file to pass to the SHOW program. The SHOW.ASM source file is a good file to use.
3. Choose OK to set the program arguments. PWB saves the arguments so that you can run or debug the program many times with the same command line.
4. From the Run menu, choose Execute.

SHOW will display the first screen of text in the file you passed to it. You can use the arrow keys and PAGE UP and PAGE DOWN to move around in the text file.

Press **Q** and then any key to return to PWB.

You have successfully created a multimodule project, built the program, and run it, all from within the Programmer's WorkBench. You can now leave PWB.

→ **To leave PWB:**

- From the File menu, choose Exit or press ALT+F4.

PWB saves your project and returns to the operating-system prompt. If you started PWB from within the Windows operating system, you will return to the Windows operating system.

Creating a PWB project is an important first step. However, most of the time you will be maintaining projects. The next section provides an overview of project maintenance. The tutorial then continues with the SHOW project.

## Project Maintenance

Once you have created a project, you may have to change it to reflect the changes in your project organization. You can:

- ◆ Add new file-inclusion directives to your source files.
- ◆ Add new source, object, or library files.
- ◆ Delete obsolete files.
- ◆ Move modules within the list.
- ◆ Change assembler and linker options.
- ◆ Change options for individual modules.

When you add a new INCLUDE directive to a source file, you add a new dependency between files. For the most accurate builds, you need to regenerate include dependencies for the project.

→ **To regenerate include dependencies:**

1. From the Project menu, choose Edit Project.
2. Select the Set Include Dependencies check box.
3. Choose Save List.

PWB regenerates the include dependencies for the entire project and rewrites the project makefile.

→ **To add new files to an existing project:**

1. From the Project menu, choose Edit Project.
2. For each file that you want to add to the project:

- ◆ Select the file from the File List box, or type the name of the file in the File Name text box.
  - ◆ Choose the Add / Delete button to add the file.
3. Choose Save List to rewrite the project makefile, set up the dependencies, and add the commands for the new files.

➔ **To delete files from a project:**

1. From the Project menu, choose Edit Project.
2. For each file that you want to remove from the project:
  - ◆ Select the file from the File List box, or type the name of the file in the File Name text box.
  - ◆ Choose the Add / Delete button to remove the file from the list.
3. Choose Save List.

With most programming languages, you won't need to move modules within a project. However, some languages or custom projects require files to be in a specific order. If you're programming in Basic, for example, you must place the main module of your program at the top of the list. Unlike other languages, Basic does not define an explicit name where execution begins. Entry to a Basic program is defined by the first file in the list.

➔ **To move a file to the top of the project file list:**

1. From the Project menu, choose Edit Project.
2. Select the file you want to move to the top of the list.
3. Choose the To Top of List button.

## Using Existing Projects

You'll now make modifications to the SHOW project that you just created. During a PWB session, the project you open remains open unless you explicitly change it. If you have not already started PWB, you should do so now. In the Windows operating system, double-click the PWB icon in the MASM program group.

If you are not compiling from within the Windows operating system, you can start PWB and open the SHOW project from the operating-system command line by typing the command:

```
PWB /PP SHOW
```

If the SHOW project is the last project you had open in PWB, type the following command:

```
PWB /PL
```

You can set up PWB to reopen the last project automatically at startup by choosing Editor Settings from the Options menu, and then by setting the Boolean switch Lastproject to Yes.

If you have already started PWB, open the project now.

➔ **To open the project from within PWB:**

1. From the Project menu, choose Open Project.
2. Choose SHOW.MAK from the File List box or type show in the Project Name text box.

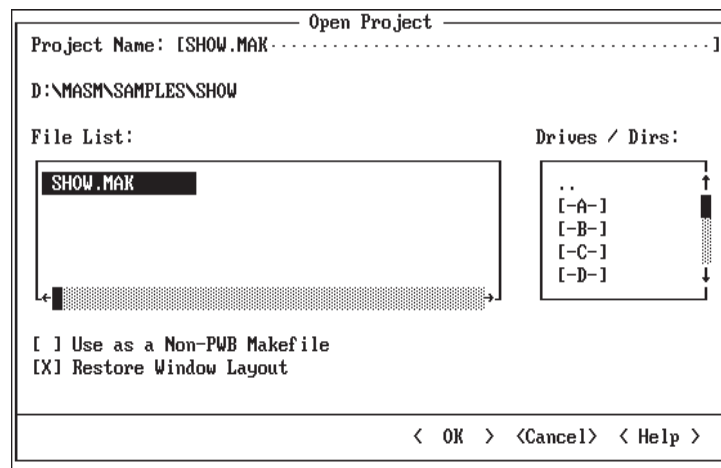

3. Choose OK.

When you open the project, PWB restores the project's environment, including:

- ◆ The window layout with the window style, size, and position for each window.
- ◆ The file history—a list of open files for each window and the last cursor position in each file.
- ◆ The last find string.
- ◆ The last replace string.
- ◆ The options that you used for the last find or find-and-replace operation, such as regular expressions. See “Using Regular Expressions” on page 82 for more information about regular expressions.
- ◆ The project template (for example, DOS EXE) and any customizations you have made to the template such as changing the build type or an assembler or linker option.
- ◆ The command-line arguments for your program.

**Note** PWB can save all environment variables, including PATH, INCLUDE, LIB, and HELPFILES, depending on how the **envcursave** and **envprojsave** switches are set. For more information, see “Environment Variables” on page 127.

Also, if you turn the **restorelayout** switch off, PWB does not restore the window layout, the find strings and options, or the file history of a project. Instead, PWB keeps the current editor state when opening a project.

---

## Adding and Deleting a Project File

As you develop a project, you will occasionally add new modules. The following example presents the steps needed to add a library file to the SHOW project. Note that this procedure is only an example, and in fact, SHOW does not use or require any library support.

➔ **To add a file to your project:**

1. From the Project menu, choose Edit Project.  
The file and directory navigation lists in this dialog box work in exactly the same way as those in the Open File dialog box.
2. Choose the parent directory symbol ( . . ) in the Drives / Dirs list box to move up the directory tree to the SAMPLES directory.
3. Choose the parent directory symbol ( . . ) again to move up the directory tree to the MASM directory.
4. Choose the LIB directory in the Drives / Dirs list box to move down the tree into the LIB directory.

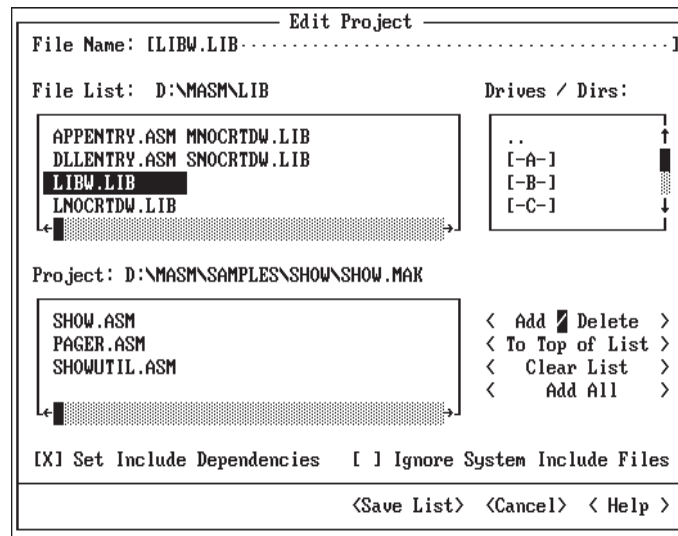

Notice that the directory displayed after the label `File List` reflects the directory change.

5. Make sure the File Name text box contains `*.*` or `*.LIB`.
6. Select `LIBW.LIB` in the File List box.
7. Choose the Add / Delete button to add the file to the project.

`LIBW.LIB` is being used here as an example of how to add a file to your project. In practice, because it is a system library that will not change, there is no reason to add it. However, if you have a library of your own that is being used by your project, you would add it to the project in this way.

8. Since `LIBW.LIB` is not a source file and cannot have include dependencies, you can clear the Set Include Dependencies check box. If this check box is selected, PWB regenerates the dependencies for all the files in the project.
9. Choose Save List.

`LIBW.LIB` is now part of the project. Since `SHOW` is not a program designed to run under Microsoft Windows, you should now delete this library from the project again.

➔ **To delete a file from your project:**

1. From the Project menu, choose Edit Project.
2. In the Edit Project dialog box, you can either select `LIBW.LIB` in the Project list box and then select Add / Delete, or simply double-click on `LIBW.LIB` in the Project list box to delete it.

## Changing Assembler and Linker Options

Up to this point, you have used PWB's default build options for all the examples. These options are sufficient for most cases, but in special cases, you will want to adjust them.

When you are debugging a program, you should choose the debug build type. When producing a debug build, the assembler and linker include a good deal of extra information in the program for CodeView to use in debugging. When you are ready to use the program, choose the release build type, so that the extra debugging information is no longer incorporated into the program.

➔ **To specify whether a build should be for release or debug:**

1. From the Options menu, choose Build Options.
2. Choose Use Debug Options or Use Release Options in the Build Options dialog box.
3. Choose OK.

When you specify a release build, PWB does not change your debug options. For more information on global options, debug options, and release options, see "Setting Build Options" on page 18.

➔ **To change assembler options:**

1. From the Language Options cascaded menu on the Options menu, choose MASM Options.

The Macro Assembler Global Options dialog box contains a number of options that are common to both the release and debug builds.

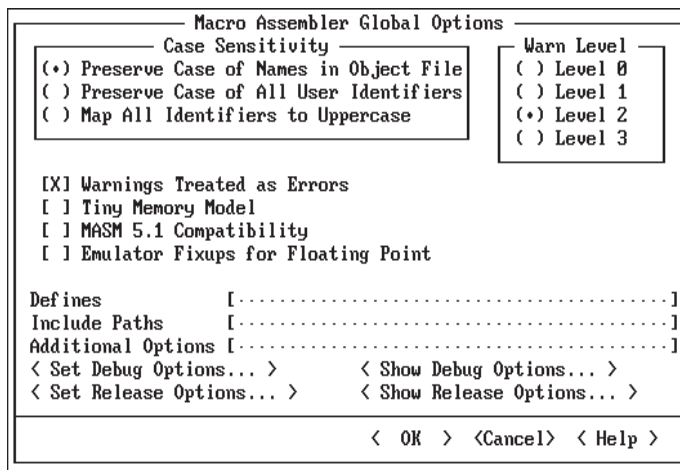



At the bottom of the dialog box are buttons that set options that are specific to the current type of build (debug or release), and that show the assembler flags corresponding to those options. Default settings were determined when you chose the project template.

---

**Note** You can choose the Set Debug Options button to view and set the options for debug builds. However, this does not change the type of build that is performed when you build the project. To set the type of build, choose Build Options from the Options menu.

---

2. Choose Set Debug Options.

PWB displays a dialog box in which you can specify debug options.

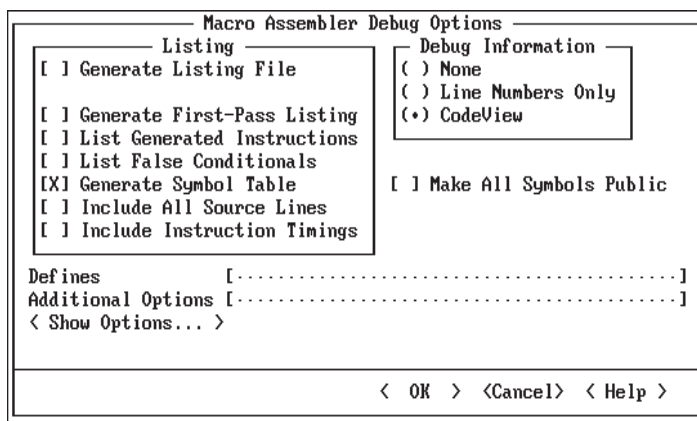

If you had chosen Set Release Options, PWB would have displayed the same dialog box, so that you could select options for release builds.

3. Choose OK to return to the Macro Assembler Global Options dialog box.
4. Choose OK to save the new assembly options and return to the main PWB screen.

→ **To change the linker options:**

1. From the Options menu, choose LINK Options.

PWB displays the LINK Options dialog box.

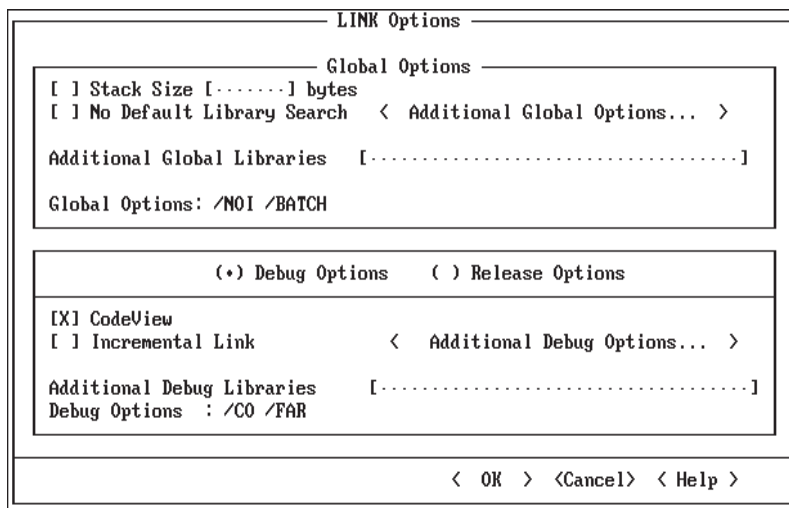

2. Choose Additional Global Options to review and select additional global link options.

PWB displays the Additional Global Link Options dialog box.

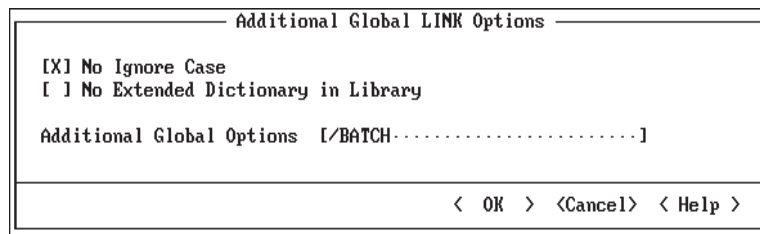

3. Choose OK when you are finished to return to the LINK Options dialog box.
4. Choose Additional Debug Options to review and select additional debug link options.

PWB displays the Additional Debug Options dialog box.

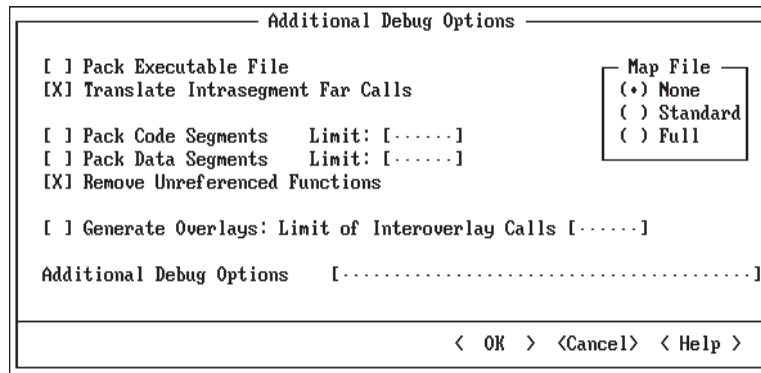

5. Choose OK when you are finished to return to the LINK Options dialog box.
6. Choose OK to close the LINK Options dialog box and use any new options you might have set.

You are now ready to build your project with any new options you have selected.

→ **To build a modified project:**

- From the Project menu, choose Rebuild All.

## Changing Options for Individual Modules

Most of the modules in a program can generally be built using the same options. However, you may occasionally want to modify the options for a single module.

The example that follows shows how to customize your project to change the assembler options for PAGER.ASM only. To do this, you manually edit the instructions in the project makefile for compiling PAGER.ASM.

→ **To open SHOW.MAK for editing:**

1. If the SHOW project is open, choose Close Project from the Project menu.  
This step is important because you cannot edit a PWB makefile for a project that is currently open.
2. Choose the Open command from the File menu and open the SHOW.MAK file in the editor.

→ **To customize the assembly of PAGER.ASM:**

1. Find the rule for compiling PAGER.ASM:

```
PAGER.obj : PAGER.ASM show.inc
!IF $(DEBUG)
    $(ASM) /c $(AFLAGS_G) $(AFLAGS_D) /FoPAGER.obj PAGER.ASM
!ELSE
    $(ASM) /c $(AFLAGS_G) $(AFLAGS_R) /FoPAGER.obj PAGER.ASM
!ENDIF
```

This rule contains a conditional statement with two commands. The first command is for debug builds, and the second command is for release builds. You can edit either one of these commands, or both. They contain the following macros defined earlier in the makefile:

Macro	Definition
ASM	The name of the MASM assembler
AFLAGS_G	Global options for assembly
AFLAGS_D	Debug options for assembly
AFLAGS_R	Release options for assembly

As an example, suppose that PAGER.ASM contained data structures which you want to pack on 32-bit boundaries for the release build only. The `/Zp4` flag tells the ML program to pack data structures on 4-byte boundaries.

2. Edit the release build command as follows.

```
$(ASM) /c $(AFLAGS_G) $(AFLAGS_R) /Zp4 /FoSHOWUTIL.obj SHOWUTIL.ASM
```

Because it is hard to be sure what options the flags macros will invoke, the new option should be placed *after* them, so that it will supersede any instructions they may contain.

Note that both the assembler options, such as `/Zp`, and NMAKE macros, such as `AFLAGS_G`, are case sensitive and must appear exactly as shown.

---

**Warning** After this modification, PWB still recognizes this makefile as a PWB makefile. However, if you make changes beyond adding options to individual command lines, PWB may no longer recognize the file as a PWB makefile. If this happens, you can delete the makefile and re-create it, or you can use it as a non-PWB makefile. For more information on using non-PWB makefiles, see “Using a Non-PWB Makefile” on page 55.

---

You could save your changes to the makefile by choosing Save from the File menu, then reopen the project and rebuild SHOW with the custom option you just installed. Because PAGER.ASM does not contain any data declarations, however, the new options have no real purpose or effect.

## The Program Build Process

This section explains the correspondence between projects and makefiles. Normally, the build process is automatic, but you may encounter situations that require customized build options. Read this section to learn how the utilities work with PWB. The following diagram illustrates the PWB build process.

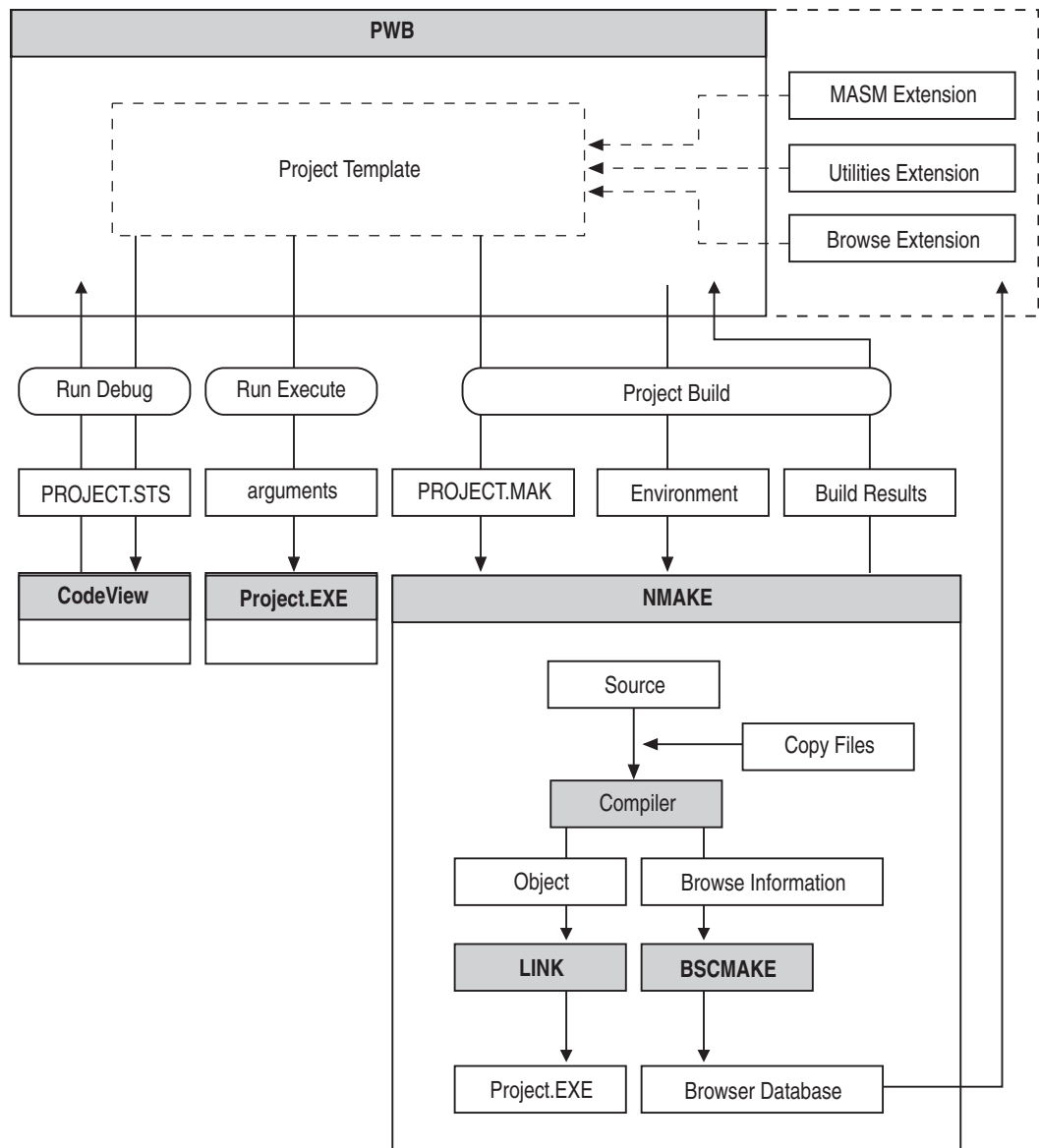

Figure 3.2 The PWB Build Process

When you save your project by choosing the Save button in the Edit Project dialog box, PWB uses the list of files along with the rules in the selected project template to scan for dependencies and write the project makefile.

When you choose the Build or Rebuild All command from the Project menu, PWB releases as much memory as possible and passes the makefile to NMAKE, which builds the project.

NMAKE stops at the end of the first build step that produces an error (as opposed to a warning) or at the end of a successful build. In either case, NMAKE returns the results of the build to PWB along with a log of any errors and warnings. For more information about NMAKE, see Chapter 16, “Managing Projects with NMAKE.”

PWB saves the output of the build for you to view in the Build Results window or to step through when you choose the Next Error (SHIFT+F3), Previous Error (SHIFT+F4), and Goto Error commands on the Project menu. You can run the program, set program arguments, and debug the program by choosing commands in the Run menu.

If you have turned on the generation of browser information, PWB builds the browser database when you build the program. Once you have a browser database, you can use the commands in the Browse menu to navigate your program’s source files and examine the structure of your program. For more information, see “Using the Source Browser” on page 88.

## Extending a PWB Project

Makefiles that are not written by PWB often contain utility targets that are not used in the process of building the project itself. These targets are used to clean up intermediate files, perform backups, process documentation, or automate other tasks related to the project. You can extend a PWB makefile to perform these kinds of tasks by adding new rules. These additional rules must be placed in a special section of the project makefile.

In the following example you will add a section that creates a file with information about the project. This file has the same base name as the project and the extension .LST. It lists the files in the project and the major options used for the build. This example section can be used with any assembly-language PWB project.

Use the SHOW project to see how to add a custom section. If you have been following the tutorial, you have already made one custom edit to the SHOW.MAK file.

→ **To add a custom section to the PWB makefile:**

1. If the project is open, choose Close Project from the Project menu.  
This step is crucial because PWB disables modification of the project makefile until the project is closed or a different project is opened. (This restriction does not apply to non-PWB project makefiles.)
2. From the File menu, choose the Open command and open the SHOW.MAK file in the editor.
3. Press CTRL+END to move the cursor to the end of the makefile.
4. Type the following new comment line *exactly* as shown:

```
# << User_supplied_information >>
```

You must put the number sign (#) in column one and type the contents of the line exactly as shown, including capitalization. Failing to type this line accurately will make the project unrecognizable to PWB or will cause PWB to change your custom build information in unexpected ways.

You can copy this line from Help rather than typing it in, if you wish. Press ALT+A, type USI, press F1, and then copy the line. Move back to the make file, and paste the line in at the end.

NMAKE requires space between rules. Therefore, you should separate this line from the lines above it by one blank line. Similarly, you should leave at least one line between the separator and your custom build rules. For more information about NMAKE and the syntax of makefiles, see Chapter 16, “Managing Projects with NMAKE.”

This comment line is used by PWB as a separator. Anything above this comment is regarded as belonging to PWB, and you should not edit the information there. The exception is to add options to individual command lines, as described in “Changing Options for Individual Modules” on page 49. Anything in the makefile after the separator is your information, and PWB ignores it. NMAKE, however, processes the entire file.

Now that you have a separator to show PWB where your custom information starts, you can add the custom information. The separator and custom section is included in the following text, and can also be found in the EXTRA.TXT file in the SAMPLES directory:

```
# << User_supplied_information >>

# Example 'user section' for PWB project makefiles,
# used in the PWB Tutorial.
#
# NOTE: This is not a standalone makefile.
#       Append this file to makefiles created by PWB.
#
# This user section adds a new target to build a project
# listing that shows the build type, options, and a list
# of files in the project.
#

!IFDEF PROJ
!ERROR Not a standalone makefile.
!ENDIF
!IF $(DEBUG)
BUILD_TYPE = debug
!ELSE
BUILD_TYPE = release
!ENDIF

# Project files and information-list target
#
$(PROJ).bld : $(PROJFILE)
    @echo <<$(PROJ).bld : Project Build Information
Build Type:      $(BUILD_TYPE)
Program Arguments: $(RUNFLAGS)
Project Files
    $(FILES: =^
    )
Assembler Options
    Global:  $(AFLAGS_G)
    Debug:   $(AFLAGS_D)
    Release: $(AFLAGS_R)
Link Options
    Global:  $(LFLAGS_G)
    Debug:   $(LFLAGS_D)
    Release: $(LFLAGS_R)
<<KEEP
```

The custom section of a PWB makefile can use any of the information defined by PWB. This example takes advantage of many macros defined by PWB. For example, the PROJFILE macro, which contains the name of the project makefile, is used as the dependent of the listing file so that the listing is rebuilt whenever the project makefile changes.

In addition, this custom section uses many features of NMAKE, including macros, macro substitution, preprocessing directives, and inline files. For more information



about NMAKE and makefiles, see Chapter 16, “Managing Projects with NMAKE.”

→ **To rebuild using the custom options:**

1. Choose Open Project from the Project menu and reopen the SHOW project.
2. From the Project menu, choose Build Target.
3. Type the name of the new target `SHOW.BLD` in the Target text box, and then choose OK.

PWB informs you that the build options have changed and asks if you want to rebuild everything.

4. Choose Yes to confirm that you want to rebuild everything.

The project information file that is created shows the project name, indicates whether the build is a debug or release build, lists the files in the project, and lists the assembler and linker options used for the build.

## Using a Non-PWB Makefile

PWB makefiles are highly structured and stylized makefiles that are generated from the rules in the project template and a list of files that you supply. Many projects have existing makefiles that PWB can't read because they do not have this stylized structure. These makefiles are called non-PWB or “foreign” makefiles.

You can still take advantage of many of PWB's project features with non-PWB makefiles. The features that cannot be used are shown as unavailable menu items. Note that a PWB makefile is not required to use the Source Browser—all you need to have is a browser database. For information on building a browser database, see “Building Databases for Non-PWB Projects” on page 94.

→ **To use a non-PWB make file:**

1. From the Project menu, choose Open Project.
2. Select the non-PWB make file to open.
3. Select the Use as a Non-PWB Makefile check box.

The Open Project dialog box appears.

4. Choose OK.

---

**Note** A PWB makefile cannot be edited or modified when it is the open project. However, PWB does not disable modification of non-PWB makefiles. You can edit a non-PWB makefile, even when it belongs to the currently open project.

---

You can now use the Build, Rebuild All, and Build Target commands from the Project menu. The Build and Rebuild All commands work as they do with a PWB makefile by building the first target. However, the Language Options commands and the LINK Options command on the Options menu are unavailable. You set these kinds of options by editing the makefile.

When you close a non-PWB project, PWB saves the environment, window layout, and file history just as it does for a PWB project.

## Where to Go from Here

This concludes the PWB tutorial section of this manual. If you wish, you can leave PWB by choosing Exit from the File menu (or by pressing ALT+F4).

Chapter 4, "User Interface Details," explains how to start PWB, describes the elements of the user interface, and gives you an overview of the menus.

Chapter 5, "Advanced PWB Techniques," explains search techniques (including regular-expression searching), describes how to use the browser, and shows how to write PWB macros.

Chapter 6, "Customizing PWB," describes how to change the behavior of PWB to suit your needs.

Chapter 7, "PWB Reference," contains an alphabetical reference to PWB menus, keys, functions, predefined macros, and switches.

---

## CHAPTER 4

# User Interface Details

This chapter summarizes the PWB user interface. It contains:

- ◆ General information on starting PWB.
- ◆ Instructions on how to use elements of the PWB screen.
- ◆ A description of the indicators on the status bar.
- ◆ A summary of every PWB menu command.
- ◆ Instructions on how to use menus and dialog boxes.

## Starting PWB

You can start PWB in either of the following ways:

- ◆ From the the Windows operating system Program Manager
- ◆ From the operating-system command line

## From the Command Line

→ **To start PWB from the command line:**

- At the operating-system prompt, type:

```
PWB [[options ]] [[filename]]
```

PWB starts with its default startup sequence.

For a complete list of PWB options and their meanings, see “PWB Command Line” on page 131. Sometimes, you will want to modify the default startup sequence. The following procedures are examples of how you can start PWB to accommodate different circumstances.

→ **To start PWB with an existing PWB project:**

- Type `PWB /PP project.mak`

PWB opens the specified project and the files that you were working on with the project.

→ **To start PWB with the project you used in your last session:**

- Type `PWB /PL`

As with the previous option, the `/PL` option opens a project and arranges your screen as it was when you left PWB.

→ **To start PWB quickly for editing a file such as CONFIG.SYS:**

- Type `PWB /DAS /t CONFIG.SYS`

This command suppresses autoloading of extensions and status files (`/DAS`). It also tells PWB not to remember `CONFIG.SYS` for the next PWB session (`/t CONFIG.SYS`).

## Using the Windows Operating System Program Manager

Microsoft Windows offers features that can enhance program development, particularly if you plan to develop Windows-based applications. You can edit and build your application in an MS-DOS session and then immediately run it under the Windows operating system. See *Getting Started* for a full description of how to set up Windows operating system icons for MASM in the Windows Program Manager.

To start PWB with Windows, double-click the PWB icon.

You can add a Program Item to the Program Manager for each project you are working on. Use the PIF editor to open `PWB.PIF`, and then choose `Save As` on the `File` menu to create a `.PIF` file with the same base name as your project. Next, use the `Optional Parameters` text box to specify the `/PF` or `/PP` options and the name of the project makefile.

To run PWB in a window by default, you can change “`Display Usage`” in the PIF file to “`Windowed`” and (optionally) “`Execution`” to “`Background`.” Then, choose `Project Templates` on the `Options` menu. In the `Build Rule` edit field of the `Customize Project Templates` dialog box, type: `macro WXFLAGS "/w"` and select `Set Build Rule`. Choose `OK`.

## Using the Windows Operating System File Manager

When programming, you are often concentrating on which file or project you want to work on and would prefer that the computer provide the right tool for the job. With the Windows File Manager, you can associate certain types of files with the commands that operate on those files. Therefore, when you double-click the filename in the File Manager, the right tool starts with the correct command-line options.

You can associate project makefiles (.MAK files) with the PWB .PIF file. Double-clicking a project makefile then starts PWB and opens that project, source files and all.

→ **To associate PWB with .MAK files:**

1. Select any file in the File Manager with the extension .MAK.
2. From the File menu, choose Associate.
3. Type the command `PWB.PIF` in the dialog box. (Make sure that your PWB.PIF file specifies a question mark (?) in the Optional Parameters text box.)

Now when you double-click a project makefile, the File Manager automatically starts PWB, and PWB opens that project.

---

**Note** Be sure you have set your PATH, INIT, and TMP environment variables prior to starting the Windows operating system so PWB can find all its files.

---

## The PWB Screen

Figure 4.1 shows the PWB display. The table which follows it describes each of the user interface elements.

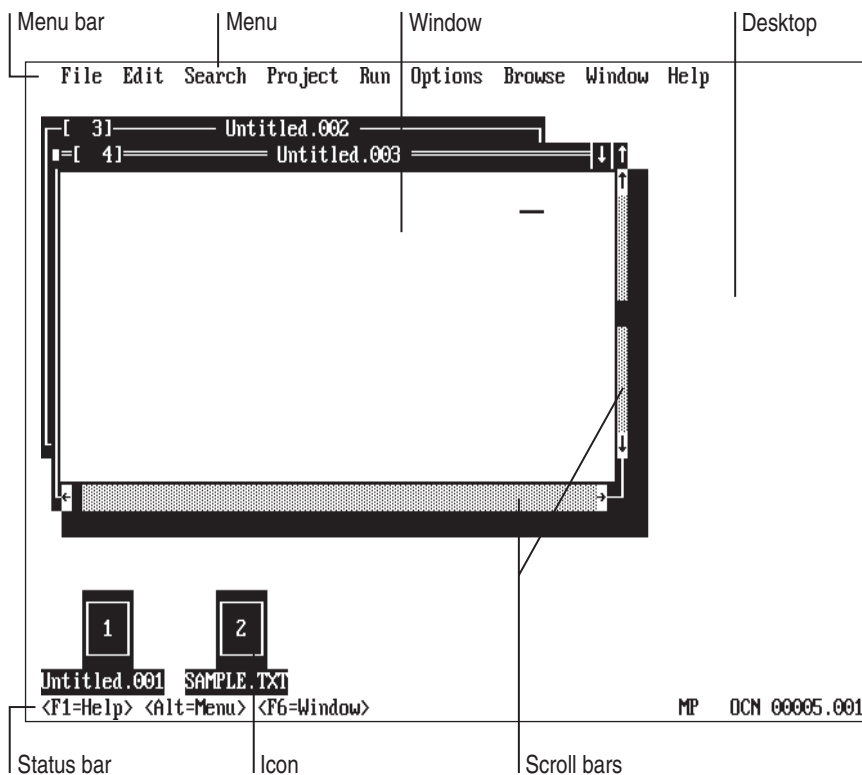

**Figure 4.1 User Interface Elements**

Name	Description
Menu bar	Lists available menus.
Menu	Lists PWB commands.
Desktop	Background area.
Icon	Displays a window in compact form.
Window	Contains source code; displays Help, browser results, build results, or error messages.
Scroll bars	Change position in file or list.
Status bar	Shows command buttons for the mouse and shortcut keys; summarizes commands and file and keyboard status.

Figure 4.2 shows a PWB window. The table which follows it describes each of a window's elements.

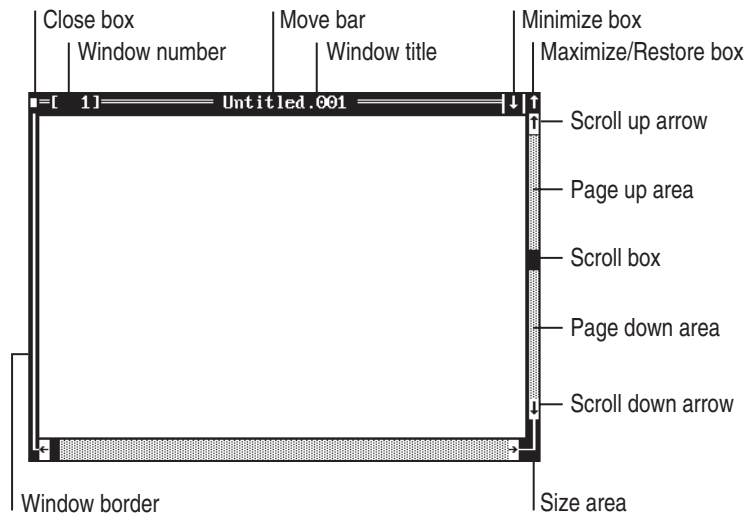

**Figure 4.2 Window Elements**

Name	Description
Window border	Moves window. Drag to move the window.
Close box	Closes the window. Click to close the window.
Window number	Identifies window. Press ALT+number to move to that window.
Window title	Indicates window contents, a filename, or pseudofile title.
Minimize box	Shrinks window to an icon. Click to minimize the window.
Maximize/Restore box	Enlarges window to maximum size or restores window to its original size.
Scroll up arrow	Scrolls up by lines. Click to scroll up.
Page up area	Scrolls up by pages. Click to page up.
Scroll box	Indicates relative position in the file. Drag to change position.
Page down area	Scrolls down by pages. Click to page down.
Scroll down arrow	Scrolls down by lines. Click to scroll down.
Size area	Sizes window. Drag to size the window.
Move bar	Moves window. Drag to move the window.

Figure 4.3 shows the PWB status bar. The table which follows it describes each of the status bar's elements.

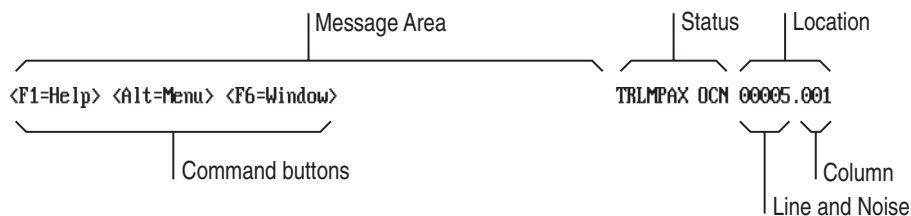

**Figure 4.3 Status Bar Elements**

Name	Description
Message area	Shows command buttons for the mouse and shortcut keys, and summarizes commands.
Status	Indicates current file, editor, and keyboard status, as described in the following table.
Location	Shows the location of the cursor in the file.
Command buttons	Show common commands and shortcut keys. Click the button or press the key to execute the command.
Line	Indicates the line at the cursor. When scanning a file during a search or when loading a file, PWB displays the current line in the line indicator as specified by the <b>Noise</b> switch.
Column	Indicates the column at the cursor.

The status area of the status bar displays one of the following letters to indicate the corresponding status.

Letter	Description
T	File is temporary and is not recorded in the PWB status file.
R	File is no-edit (read-only); modification is disabled.
L	Line endings in the file are linefeed characters only.
M	File is modified.
P	File is a pseudofile.
A	Meta prefix (F9) is active.
X	Macro recording is turned on.
O	Overtyping mode is enabled. In insert mode, no indicator appears.
C	CAPS LOCK is on.
N	NUM LOCK is on.



Figure 4.4 shows the Window menu with the PWB Windows cascaded menu pulled down. The table which follows it describes each element of a menu.

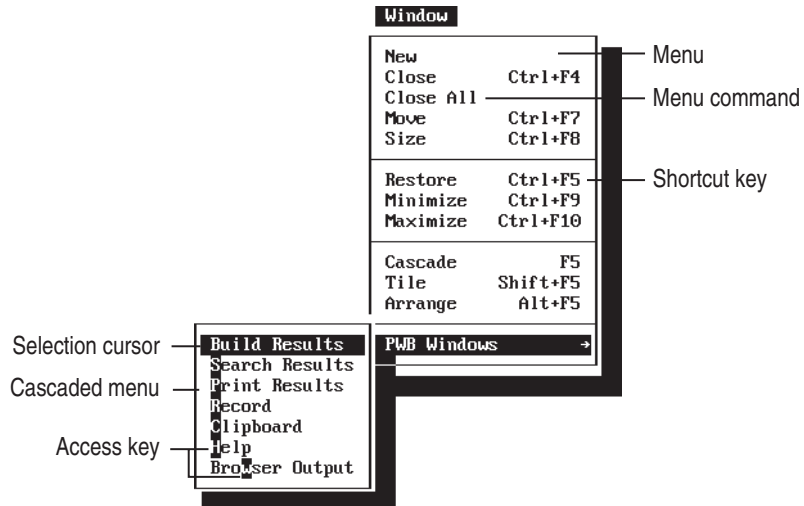

**Figure 4.4 PWB Menu Elements**

Name	Description
Menu	Displays a list of commands.
Menu command	Executes the command. When the command is dimmed, it is unavailable.
Shortcut key	Executes the command directly and bypasses the use of the menu. Press the key to execute the command.
Cascaded menu	Lists a group of related commands. The command for a cascaded menu has a small right arrow after the command. To open a cascaded menu, click the command or move the selection cursor to the command and press the RIGHT ARROW key. To close an open cascaded menu, press the LEFT ARROW key.
Access key	Executes the command. Press the highlighted letter key to execute the command.
Selection cursor	Indicates the selected command. Press the UP ARROW and DOWN ARROW keys to move the selection cursor. Press ENTER to execute the command.

## PWB Menus

PWB commands are organized into menus; the menu names appear along the menu bar at the top of the screen. When a menu or command is selected, PWB displays a brief description of the selected menu on the status bar. To get more information about a menu or command, point the mouse cursor to the name and click the right mouse button, or highlight the name by using the arrow keys and then press F1.

### File

The File menu provides commands to open, close, and save files. You can switch to any open PWB file or find a specific file on your disk. You can also print a selection, a file, or a list of files.

<b>Command</b>	<b>Description</b>
<b>New</b>	Start a new file
<b>Open</b>	Open an existing file
<b>Find</b>	Locate a file or list of files on disk
<b>Merge</b>	Merge one or more files into the current file
<b>Next</b>	Open the next file in the list of files specified on the command line
<b>Save</b>	Save the current file
<b>Save As</b>	Save the current file with a different name
<b>Save All</b>	Save all modified files
<b>Close</b>	Close the current file
<b>Print</b>	Print a selection, the current file, or a list of files
<b>DOS Shell</b>	Temporarily exit to the operating system
<b>All Files</b>	List all open files in PWB
<b>Exit</b>	Leave PWB

### Edit

The Edit menu provides commands to manipulate text, set the selection mode, and record macros.

<b>Command</b>	<b>Description</b>
<b>Undo</b>	Reverse the effect of your recent edit
<b>Redo</b>	Reverse the effect of the last Undo
<b>Repeat</b>	Repeat the last edit
<b>Cut</b>	Delete selected text and copy it to the clipboard

<b>Command</b>	<b>Description</b>
<b>Copy</b>	Copy selected text to the clipboard
<b>Paste</b>	Insert text from the clipboard
<b>Delete</b>	Delete selected text without copying it to the clipboard
<b>Set Anchor</b>	Save the current cursor position
<b>Select To Anchor</b>	Select text from the anchor to the cursor
<b>Stream Mode</b>	Set stream selection mode
<b>Box Mode</b>	Set box selection mode
<b>Line Mode</b>	Set line selection mode
<b>Read Only</b>	Toggle the PWB no-edit state (to prevent accidental modification or to allow modification)
<b>Set Record</b>	Define a macro name and its shortcut key
<b>Record On</b>	Record commands for a macro

## Search

The Search menu provides commands to perform single-file and multifile text and regular-expression searches. You can do single-file and multifile find-and-replace operations. You can define and jump to marks or go to specific lines.

<b>Command</b>	<b>Description</b>
<b>Find</b>	Search for an occurrence of a text string or pattern
<b>Replace</b>	Search for a string or pattern and replace it with another
<b>Log</b>	Turn multifile searching on and off
<b>Next Match</b>	Move to the next match
<b>Previous Match</b>	Move to the previous match
<b>Goto Match</b>	Go to the match at the cursor in the Search Results window
<b>Goto Mark</b>	Move to a mark or line number
<b>Define Mark</b>	Set a mark at the cursor
<b>Set Mark File</b>	Open or create a mark file

## Project

The Project menu provides commands to open and create projects, build a project or selected targets in the project, and determine the location of build errors and messages.

<b>Command</b>	<b>Description</b>
<b>Compile File</b>	Compile or assemble the current source file
<b>Build</b>	Build the project
<b>Rebuild All</b>	Build all files in the project (even those that have not been modified)
<b>Build Target</b>	Build specific targets in the project
<b>New Project</b>	Create a new project
<b>Open Project</b>	Open an existing project
<b>Edit Project</b>	Change the list of files in the project
<b>Close Project</b>	Remove the current project from memory without changing its contents
<b>Next Error</b>	Move to the next error
<b>Previous Error</b>	Move to the previous error
<b>Goto Error</b>	Move to the error at the cursor in the Build Results window

## Run

The Run menu provides commands to set arguments for the project's program, run and debug the program, run operating-system commands, and add or run custom Run menu commands.

<b>Command</b>	<b>Description</b>
<b>Execute</b>	Run the current program
<b>Program Arguments</b>	Specify commands passed to your program for Execute or Debug
<b>Debug</b>	Run CodeView for the current program
<b>Run DOS Command</b>	Perform any single DOS task without exiting PWB
<b>Customize Run Menu</b>	Add commands to the Run menu

The custom commands that you add to the Run menu appear after the Customize Run Menu command.

## Options

The Options menu provides commands to set environment variables for use within PWB, customize the look and behavior of PWB, and assign keys to commands. For projects, you can set the build type, customize the project template, and set assembler and utility options.

Command	Description
<b>Environment Variables</b>	View and modify environment variables
<b>Key Assignments</b>	Assign keys that invoke functions and macros
<b>Editor Settings</b>	Change the setting of any PWB switch
<b>Colors</b>	Change screen colors
<b>Build Options</b>	Specify whether the program is built as a debug or release version; specify a build directory
<b>Project Templates</b>	Cascaded menu of commands for project templates
<b>Language Options</b>	Cascaded menu of compiler options commands

The Project Templates cascaded menu provides the following commands to manage project templates:

Command	Description
<b>Set Project Template</b>	Changes the run-time support and project template
<b>Customize Project Template</b>	Modify the current project template
<b>Save Custom Project Template</b>	Save the current template as a new, custom template
<b>Remove Custom Project Template</b>	Delete custom project templates

The Language Options cascaded menu provides the following commands for setting assembler and compiler options for any other languages that may be installed:

Command	Description
<b>MASM Options</b>	Set assembler options

**Note** Additional languages, such as Basic and FORTRAN, are listed when their PWB extensions are loaded. To load the Basic extension, rename PWBBASIC.XXT in the BIN subdirectory to PWBBASIC.MXT. For FORTRAN, do the same for PWBFORT.XXT.

The following commands appear when the utilities extension (PWBUTILS) is loaded:

Command	Description
<b>LINK Options</b>	Set linker options for your project
<b>NMAKE Options</b>	Set options for NMAKE when it builds the project
<b>CodeView Options</b>	Set options for CodeView when debugging the project

The following command appears when the browser extension (PWBROWSE) is loaded:

Command	Description
<b>Browse Options</b>	Define the way the Source Browser database is built

## Browse

The Browse menu provides the commands for the PWB Source Browser. You can select a browser database. You can jump to specific definitions or symbols in your project and view complex relationships among program symbols. You can also view your program as an outline, function-call tree, or, if you are using Microsoft C++, you can even view it as a class-inheritance tree.

Command	Description
<b>Open Custom</b>	Open a custom browser database, open the project database, or save the current database
<b>Goto Definition</b>	Locate the definition of any symbol in your source code
<b>Goto Reference</b>	Locate the references to any name in the browser database
<b>View Relationship</b>	Query the browser database
<b>List References</b>	Display a list of functions that call each function and show the use of each variable, type, macro, or class
<b>Call Tree (Fwd/Rev)</b>	View which functions call other functions
<b>Function Hierarchy</b>	Display a program outline
<b>Module Outline</b>	Display an outline of program modules
<b>Which Reference?</b>	Display a list of possible references for the ambiguous reference at the cursor
<b>Class Tree (Fwd/Rev)</b>	View the class-inheritance tree (for the C++ language)
<b>Class Hierarchy</b>	View the hierarchy of classes (for the C++ language)
<b>Next</b>	Find the next definition or reference
<b>Previous</b>	Find the previous definition or reference
<b>Match Case</b>	Define whether or not browse queries are case sensitive

## Window

The Window menu provides commands to manipulate and navigate windows in PWB.

<b>Command</b>	<b>Description</b>
<b>New</b>	Duplicate the active window
<b>Close</b>	Close the active window
<b>Close All</b>	Close all windows
<b>Move</b>	Start window-moving mode for the active window
<b>Size</b>	Start window-sizing mode for the active window
<b>Restore</b>	Restore a minimized or maximized window to normal size
<b>Minimize</b>	Shrink the active window to an icon
<b>Maximize</b>	Enlarge windows to maximum size
<b>Cascade</b>	Arrange windows to show all their titles
<b>Tile</b>	Arrange windows so that none overlap
<b>Arrange</b>	Organize windows in a useful configuration for viewing Help, source code, and Build Results
<b>PWB Windows</b>	Cascaded menu that lists the following special PWB windows:
<b>PWB Window</b>	<b>Description</b>
<b>Build Results</b>	View the results of builds
<b>Search Results</b>	View the results of logged searches
<b>Print Results</b>	View the results of print operations
<b>Record</b>	View, edit, save recorded macros
<b>Clipboard</b>	View the PWB clipboard
<b>Help</b>	Access the Help system
<b>Browser Output</b>	View the results of browser queries
<b>1 window1</b>	Move to window <i>n</i>
...	
<b>5 window5</b>	
<b>All Windows</b>	View a list of all open windows

The All Windows command does not appear until the full list of open windows is too long to fit on the menu.

## Help

The Help menu contains commands to access the Microsoft Advisor Help system. You can see the index or table of contents for the system, get context-sensitive Help, and perform global plain-text searches in the Help.

<b>Command</b>	<b>Description</b>
<b>Index</b>	Display a list of available indexes
<b>Contents</b>	Display a table of contents for each component of the Help system
<b>Topic</b>	Display Help about the item or keyword at the cursor
<b>Help on Help</b>	Display information on how to use Help
<b>Next</b>	Display the next Help screen that has the same name as the topic you last viewed
<b>Global Search</b>	Search all open Help files for a string or regular expression
<b>Search Results</b>	View the results of the last global Help search
<b>About</b>	Display the PWB copyright and version number

## Executing Commands

PWB commands appear in menus and as “buttons.” You can execute these commands in two ways:

- ◆ With a Microsoft Mouse or any fully compatible pointing device  
You perform mouse operations by “clicking”—moving the mouse cursor to the specified item and briefly pressing the left mouse button. “Double-click” by pressing the left button twice, quickly. Always use the left mouse button unless specifically instructed otherwise.
- ◆ With the keyboard

## Choosing Menu Commands

- ➔ **To choose a menu command with the mouse:**
  1. Click the menu name to open the menu.
  2. Click the command.
- ➔ **To choose a menu command from the keyboard:**
  1. Press the ALT key to activate the menu bar.
  2. Press the highlighted character in the menu name (such as F for File).



An alternative is:

1. Press the ALT key to activate the menu bar.
2. Use the RIGHT ARROW and LEFT ARROW keys to select a menu.
3. Press ENTER to open the menu.
4. Press the highlighted character in the command name (such as S for Save in the File menu), or use the UP ARROW and DOWN ARROW keys to select the command and then press ENTER.

There are several ways to close an open menu without executing a command.

→ **To close a menu without executing a command:**

- Do one of the following procedures:
  - ◆ Click outside of the menu.
  - ◆ Press ESC.
  - ◆ Press ALT twice.

When a menu command is dimmed (rather than black), it is unavailable. For example, when no windows are open, the Close command on the File menu is unavailable. If a command you want to use is unavailable, you must perform some other action or complete a pending action before you can invoke that command.

## Shortcut Keys

Some commands are followed by the names of keys or key combinations. Press the shortcut key to execute the command immediately. You don't have to go through the menu. For example, press SHIFT+F2 to execute the Save command, which saves the current file.

All menu commands with shortcut keys and many other menu commands invoke predefined PWB macros to carry out their action. You can change the key or add new shortcut keys for these commands by assigning a key to the predefined macro. For a complete list of predefined macros and their corresponding menu commands, see "Predefined PWB Macros" on page 207. For more information on assigning keys, see "Changing Key Assignments" on page 109.

Many PWB functions have been assigned to keys besides those listed on the menus. Choose the Key Assignments command on the Options menu to view a list of functions and macros and their assigned keys.

## Buttons

You can often execute commands by using buttons or boxes, which are areas of the screen that perform an action when you click them or select them from the keyboard. For example, the rectangle at the upper-left corner of a window is the “close box.” Clicking this box with the mouse closes the window.

A command name surrounded by angle brackets (<>) appearing on the status bar or in a dialog box is a button. The following buttons are on the status bar when you first start PWB:

```
<General Help> <F1=Help> <Alt=Menu>
```

The General Help button brings up a screen that explains how to use the Help system. The other two buttons remind you of PWB functions: F1 summons Help, and ALT activates the menu bar. Clicking one of these buttons with the mouse performs the same function as pressing the key.

When you have opened more than one window, PWB displays the following buttons:

```
<F1=Help> <Alt=Menu> <F6=Window>
```

Click the Window button or press F6 to move to the next window.

When a menu is selected or a dialog box is displayed, an informative message appears on the status bar. While PWB displays this message, no buttons are available and clicking the status bar does nothing.

## Dialog Boxes

When a menu command is followed by an ellipsis (...), PWB needs more information before executing the command. You enter this information in a dialog box that appears when you choose the command.

Dialog boxes can contain any of the items in Figure 4.5.

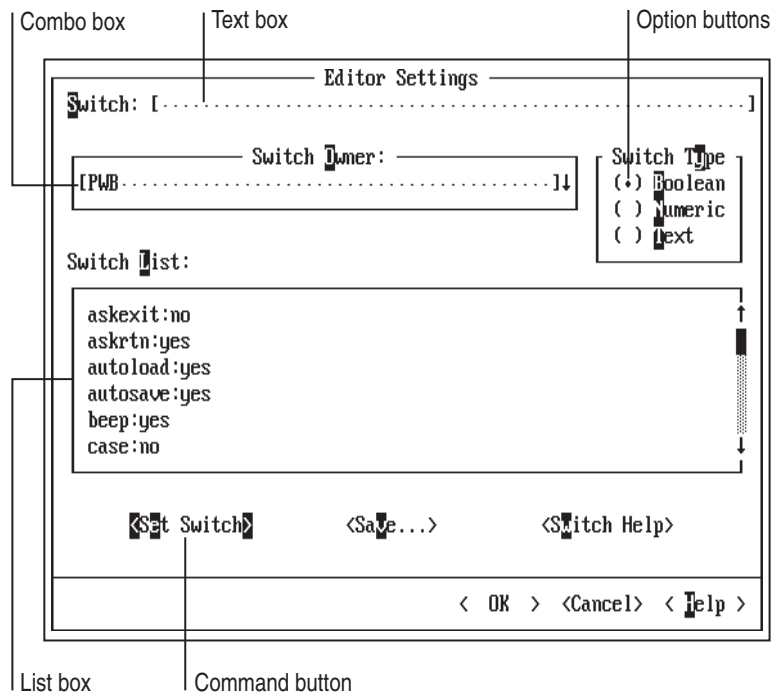

**Figure 4.5 Dialog Box Elements**

#### Option Button

A button that you select from a list of mutually exclusive choices. Click the one you want, press its highlighted letter, or use the arrow keys to move among the choices.

#### Text Box

An area in which you can type text. You can move the cursor within the text box by clicking the location with the mouse or by pressing the LEFT ARROW and RIGHT ARROW keys. You can toggle between insert and overwrite mode by pressing the INS key. To select text for deletion, click and drag the mouse over the text or press SHIFT plus an arrow key. Press DEL to delete the text, or type new text to replace the highlighted text.

#### List Box

A box displaying a list of information (such as the contents of the current disk directory). If the number of items exceeds the visible area, click the scroll bar to move through the list or press PGUP, PGDN, or the arrow keys. You can move to the next item in the list that starts with a particular letter by typing that letter.

#### Combo Box

The combination of a text box and a drop-down list box. You can type the name of an item in the text box or you can select it from the list.

To open the list, click the highlighted arrow, or press ALT+DOWN ARROW or ALT+UP ARROW. You can then click the item or press the arrow keys to select the item you want. You can also press the first letter of an item to select it. When you have selected an item, click the highlighted arrow or press ALT+DOWN ARROW or ALT+UP ARROW to close the list.

#### Command Button

A button within angle brackets (< >) that invokes a command. Choose the OK button to accept the current options, or choose the Cancel button to exit the dialog box without changing the current options. Choose the Help button to see Help on the dialog box.

If one of the command buttons in a dialog box is highlighted, press ENTER to execute that command. You can also click a command button to execute that command. If a button contains an ellipsis (...), it indicates that another dialog box will appear when you choose it.

#### Check Box

An on/off switch. If the box is empty, the option is turned off. If it contains the letter X, the option is turned on. Click the box with the mouse, or press the SPACEBAR or the UP ARROW and DOWN ARROW keys to toggle a check box on and off.

#### Key Box

A pair of braces ( { } ) that allows you to enter a key by pressing the key. The key box is always followed by a text box where you can type the name of the key.

When the cursor is in the key box (between the braces), most keys lose their usual meaning, including ESC, F1, and the dialog box access keys. The key you press is interpreted as the key to be specified. Only TAB, SHIFT+TAB, ENTER, and NUMENTER retain their usual meaning. To specify one of these keys, type the name in the text box.

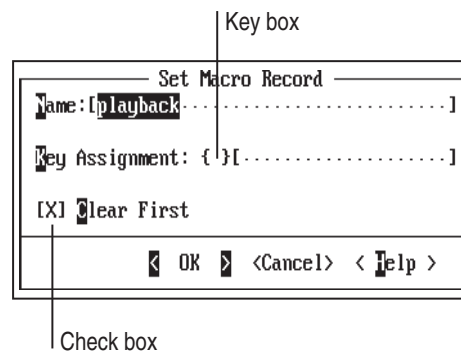

**Figure 4.6 Key Box and Check Box**

Clicking a dialog-box item either selects it (a text box, for example) or toggles its value (a check box or option button). You can also move among items with the TAB and SHIFT+TAB keys.

Dialog boxes usually contain access keys, identified by highlighted letters. Pressing an access key is equivalent to clicking that item with the mouse or moving to it by pressing TAB or SHIFT+TAB, and then pressing ENTER. Although some access keys are uppercase and others lowercase, dialog boxes are not case sensitive. Therefore, you can type either an uppercase or a lowercase character.

---

**Note** When the cursor is in a text box, access keys are interpreted as text. You must press ALT along with the highlighted letter. Pressing ALT is also required in list boxes because typing a letter by itself moves the cursor to the next item that starts with that letter.

---



## CHAPTER 5

## Advanced PWB Techniques

This chapter introduces you to some of the powerful features in the Programmer's WorkBench. It is not an exhaustive discussion of all the ways to use PWB. However, it can provide a starting point for you to begin your own investigation of PWB using the information in the Microsoft Advisor and in Chapter 7, "Programmer's WorkBench Reference."

This chapter contains:

- ◆ Find and search-and-replace techniques, including marks and regular expressions.
- ◆ How to use the PWB Source Browser.
- ◆ How to execute PWB functions and macros.
- ◆ An overview of PWB macros, macro recording, and the macro language.

### Searching with PWB

PWB offers the following ways to search your files for information:

- ◆ Visually inspecting code, moving with the cursor or the PGUP and PGDN keys. This method is most effective either when you are familiarizing yourself with some old code or after you have switched from CodeView back to PWB and want to examine the local impact of a proposed change.
- ◆ Searching with text strings. When you have a specific string in mind (for example, `FileName`), you can find, in sequence, all the references to the name in your file.
- ◆ Searching with regular expressions. Regular expressions describe patterns of text. This is useful when you have a number of similarly named program symbols and you'd like to see them all in succession.

For example, Windows API (application programming interface) names are made up of multiple words; the start of each new word is shown as a capital

letter (for example, `GetTextMetrics`). With this in mind, you might search for a string optionally starting with spaces and the letters “GetText” followed by any uppercase letter. This is expressed with a regular expression such as `*GetText[A-Z]`, which means zero or more spaces (using the `*` operator after a space), followed by `GetText`, followed by any uppercase letter (using a character class).

- ◆ Searching multiple files with text strings or regular expressions. A multifile search is called a “logged search.” Instead of finding one match, PWB finds all matches in one operation. You can then browse the results of the search.
- ◆ Using the Source Browser. The Source Browser enables you to perform faster and more sophisticated searches than plain text searches because it maintains a complete database of relationships between program symbols. For example, to find all occurrences of `FileName` in your entire program (regardless of the number of files in the program), you can use the View References command from the Browse menu.

The Source Browser has many more capabilities than just finding symbols. It can also produce call trees and perform sophisticated queries on the use-and-definition relationships among functions, variables, and classes in your program.

These searching techniques are discussed in detail in the following sections.

## Searching by Visual Inspection

If you think you’re close to the text you want to see, don’t try a fancy search—use the `PGUP` or `PGDN` key. It’s often faster. One trick you can use to speed up this method of searching is to leave a trail in the form of marks (names associated with file locations).

### Using Marks

PWB lets you set named marks at any location in your file by using the Define Mark command from the Search menu or by using the **Mark** function. You can access these locations by name using the Goto Mark command or the **Mark** function.

For example, if you are writing code and want to leave certain sections until later, or if you are revising an existing program and don’t fully understand all the algorithms, you might leave a mark at each location in the code you want to come back to. That way, you can work on some sections of the program first, and then come back to the marked areas after further research.

To save marks between PWB sessions, create a mark file using the Set Mark File command from the Search menu.



## Using the Find Command

The Find command on the Search menu allows you to search a file using text strings and regular expressions. Searching forward uses the **Psearch** function (assigned to the F3 key), while searching backwards uses the **Msearch** function (assigned to the F4 key).

Find can help you locate any string of text in any file you specify. PWB usually searches the file you are currently editing. However, it can also search a list of files. This is particularly useful for finding all occurrences of a string in an entire project. The function used is called **Mgrep**.

The results of a multifile search are logged, that is, put into the Search Results window. To see the logged results of a search, choose Search Results from the PWB Windows cascaded menu. There are two ways to use the information that PWB puts into Search Results:

- ◆ You can look at the matches in sequence by choosing Next Match and Previous Match from the Search menu.
- ◆ You can go directly to a specific match by moving the cursor to the match listed in the Search Results window and choosing Goto Match from the Search menu. PWB then jumps to the location of the match.

The Match commands on the Search menu work with the Search Results window in exactly the same way that the Project menu's Next Error, Previous Error, and Goto Error commands work with the Build Results window. These Project menu commands are described in "Fixing Build Errors" on page 23.

To illustrate the logged-search technique, suppose you want to locate all instances of a software interrupt instruction in the SHOW project's source files.

➔ **To search all the source files in this project:**

1. From the Search menu, choose Find.  
PWB brings up the Find dialog box.
2. Turn on Log Search check box.
3. Type `int` in lowercase.
4. Select the Match Case check box to exclude uppercase or mixed-case occurrences of the word.

5. Choose the Files button.

PWB brings up the Search In Selected Files dialog box.

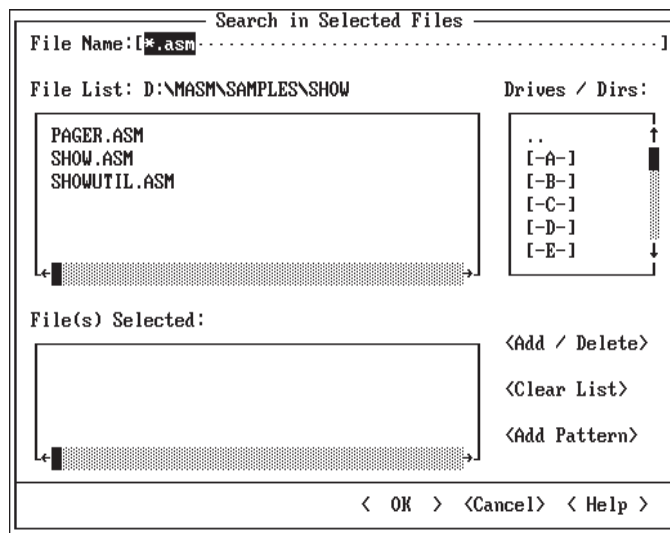

6. Type SHOW\* .ASM in the File Name text box.  
This wildcard specifies all filenames beginning with SHOW and having the .ASM extension.
7. Choose the Add Pattern button to add the wildcard to the file list.
8. In the “Drives / Dirs” window, select the SAMPLES\SHOW subdirectory under the main MASM directory.
9. Return to the File Name text box by clicking the box or by pressing ALT+F.
10. Type \$INCLUDE:dos.inc (with the environment variable, “INCLUDE,” all in caps). Preceding an environment variable name with a dollar sign causes the contents of that variable to be inserted into the search string. The INCLUDE variable normally contains the path to the directory where general-purpose include files are kept.
11. Press ENTER to add DOS.INC to the file list, or click Add / Delete.
12. Choose OK to start the search.

When PWB finishes the search, it displays the Log Search Complete dialog box.

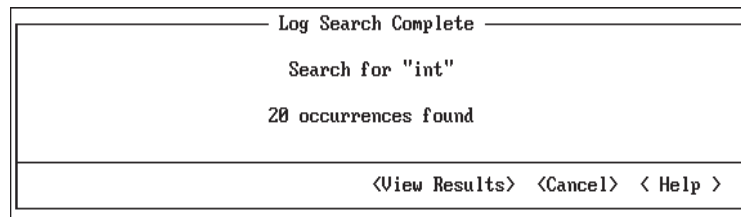

From this dialog box you can:

- ◆ Choose View Results to open the Search Results window.
- ◆ Choose Cancel to close the dialog box.

Choose Cancel now (you will open the Search Results window later).

→ **To go to the first match:**

- From the Search menu, choose Next Match.

You can step sequentially through all occurrences of the string using the Next Match command. Choose Previous Match to move to the previous occurrence of the string. When you reach the end of Search Results, PWB displays the following message:

```
End of Search Results
```

Sometimes, you cannot focus the search narrowly enough to make a sequential scan of Search Results profitable. In this example, you wanted only instances of the software interrupt instruction, but PWB found many more occurrences of **int**. In these cases, you can examine the results of the search and skip the matches that aren't relevant.

→ **To view the Search Results:**

- To see all matches from the search, open the Search Results window. You can do this by choosing Search Results from the PWB Windows cascaded menu on the Window menu.

In the Search Results window, PWB displays the file, line, and column where the string was located. It also shows as much of the matching line as will fit in the window.

```

File Edit Search Project Run Options Browse Window Help
[ 1] Search Results
+++ PWB [D:\MASM\SAMPLES\SHOW] Search int
D:\MASM\SAMPLES\SHOW\PAGER.ASM 58 49:      ADDR stLine,          ; Far
D:\MASM\SAMPLES\SHOW\PAGER.ASM 74 49:      es::si,                ; Far
D:\MASM\SAMPLES\SHOW\PAGER.ASM 108 35:    ;* that only occur at a few key points
D:\MASM\SAMPLES\SHOW\PAGER.ASM 174 29:    ;* Params: fpBuffer - Far pointer to li
D:\MASM\SAMPLES\SHOW\PAGER.ASM 275 17:    ;* Input:  BX points to start of line
D:\MASM\SAMPLES\SHOW\PAGER.ASM 276 17:    ;*      DI points to current positio
D:\MASM\SAMPLES\SHOW\PAGER.ASM 323 9:     int    10h
D:\MASM\SAMPLES\SHOW\PAGER.ASM 331 9:     int    10h
D:\MASM\SAMPLES\SHOW\SHOW.ASM 87 59:     mov    bx, sp          ;
D:\MASM\SAMPLES\SHOW\SHOW.ASM 102 9:     int    20h
D:\MASM\SAMPLES\SHOW\SHOW.ASM 116 59:     mov    cx, 0FFFFh
D:\MASM\SAMPLES\SHOW\SHOW.ASM 177 45:     mov    si, OFFSET fiFiles.FName
D:\MASM\SAMPLES\SHOW\SHOW.ASM 188 49:     mov    si, OFFSET fiFiles.FName
D:\MASM\SAMPLES\SHOW\SHOW.ASM 189 49:     mov    di, OFFSET stFile[FILE_P
D:\MASM\SAMPLES\SHOW\SHOW.ASM 234 31:    ; Open file and read contents into buffe
D:\MASM\SAMPLES\SHOW\SHOW.ASM 337 63:     repne scasb
D:\MASM\SAMPLES\SHOW\SHOW.ASM 339 52:     shl    di, 1
D:\MASM\SAMPLES\SHOW\SHOWUTIL.ASM 18 19:    ;* Return: Near pointer to position o
D:\MASM\SAMPLES\SHOW\SHOWUTIL.ASM 193 36: ;* BinToStr - Converts an unsigned i
D:\MASM\SAMPLES\SHOW\SHOWUTIL.ASM 198 20: ;*      pch - Pointer to character
<General Help> <F1=Help> <Alt=Menu>                R MP    N 00001.001

```

For example, if the instruction you were looking for is the Interrupt 10h in PAGER.ASM, you can jump directly to that location.

➤ **To jump directly to a match:**

1. Put the cursor on the match.
2. From the Search menu, choose Goto Match.

PWB opens the correct file if it is not already open and positions the cursor on the text you located.

You can use multifile searching regardless of whether the files that you want to search are open in PWB.

## Using Regular Expressions

The PWB searching capabilities that you have used so far are useful when you know the exact text you are looking for. Sometimes, however, you have only part of the information that you want to match (for example, the beginning or end of the string), or you want to find a wider range of information. In such cases, you can use regular expressions.

Regular expressions are a notation for specifying patterns of text, as opposed to exact strings of characters. The notation uses literal characters and metacharacters. Every character that does not have special meaning in the regular-expression syntax is a literal character and matches an occurrence of that character. For example, letters and numbers are literal characters. A metacharacter is an operator or delimiter in the regular-expression syntax. For example, the backslash (\) and the asterisk (\*) are metacharacters.

PWB supports two syntaxes for regular expressions: UNIX and non-UNIX. Each syntax has its own set of metacharacters. The UNIX metacharacters are `.\[\ ]*+^$`. The non-UNIX metacharacters are `?\[ ]*+^$@#( ) { }`. Because it uses fewer metacharacters, the UNIX form is a little more verbose. However, it is more familiar to programmers who have experience with UNIX tools such as **awk** and **grep**. This book uses the UNIX syntax, but any expression that can be written with this syntax can also be written with the non-UNIX syntax.

The regular-expression syntax used by PWB depends on the setting of the **Unixre** switch (this is a Boolean switch, and UNIX is the default). You can change the **Unixre** switch by using the Editor Settings dialog box on the Options Menu.

---

**Note** PWB switches that take regular expressions always use UNIX syntax. They are independent from the **Unixre** switch.

---

## Finding Text

In the multiframe searching example, you learned how to locate every occurrence of **int** in the SHOW project. In a large project, finding every **int** would yield too many matches. To narrow the search, you can use a regular expression.

For this example, let's say you want to match any **int** instruction. You can specify this with a regular expression. The expression below matches text that:

- ◆ Begins with the keyword **int**
- ◆ Is followed by white space
- ◆ Is followed by one or more hex digits (characters between 0 and 9 or between A and F)

The syntax for this regular expression is shown in Figure 5.1.

```
int\b[0-1A-Fa-f]+
```

**Figure 5.1** Regular Expression Example

It illustrates the following important features of regular expressions:

1. Regular expressions can contain literal text. In this example, `int` is literal text and is matched exactly.
2. Regular expressions can contain predefined regular expressions. Here, `\:b` is shorthand for a pattern that matches one or more spaces or tabs (that is, white space). For a complete list of predefined regular expressions, see Appendix B.
3. You can use *classes* of characters in regular expressions. A class matches any one character in the class. For example, the class `[0-9a-f]` is the class of characters that contains the digits between 0 and 9 and the lowercase letters between A and F. The dash (`-`) defines a range of characters in a class.
4. The plus sign (`+`) after the class instructs PWB to look for one or more occurrences of any of the characters in the class. This is the key to regular expressions. You don't have to know exactly what the interrupt number is; all you have to do is describe what kind of characters make it up.

The pattern `int\:b[0-9A-F]` matches strings such as

```
int    21h    ; DOS function interrupt
int    3Ah
; Print 25 lines...
```

Figure 5.2 shows a more detailed way to write an expression that matches only an **int 20h** or an **int 21h**.

```
^[^; \t]*\:bint[ \t]+0*2[0-1][hH]
```

The diagram shows the regular expression `^[^; \t]*\:bint[ \t]+0*2[0-1][hH]` with numbered annotations 1 through 9 pointing to specific parts of the expression:

- 1: Points to the caret (^) at the beginning of the expression.
- 2: Points to the character class `[^; \t]*`.
- 3: Points to the backslash (\).
- 4: Points to the character class `[b]`.
- 5: Points to the character class `[int]`.
- 6: Points to the plus sign (+) after the character class `[ \t]`.
- 7: Points to the character class `[0-1]`.
- 8: Points to the character class `[hH]`.
- 9: Points to the end of the expression.

**Figure 5.2 Complex Regular Expression Example**

This expression is more precise than most searches require, but it is useful as an illustration of how to write a complex regular expression.

You can interpret this expression as follows:

1. Start at beginning of the line, which is specified by a caret (`^`) at the beginning of the regular expression. Using an initial caret is particularly helpful in a situation like this if your file uses space characters rather than tabs. Otherwise, when you begin your search criteria with `\:b`, the search will return one match for every space character preceding the matching text. For example, if your instruction column is indented eight spaces, searching for `\:bmov\:b` will return eight copies of every `mov` instruction, one for each of the preceding space characters. Including the initial caret, however, will result in only one match per line.

2. Skip any label on the line, without matching a comment line. The `[^; \t]` indicates a class made up of any characters that are *not* a semicolon, a space or a tab character. Within brackets, a caret (^) at the beginning of the class indicates an “inverse class,” that is, one including all characters *except* the specified ones. Following the class is an asterisk, indicating that zero or more such characters may be present. In general, optional items are specified using the asterisk (\*) operator, which indicates that zero or more of the preceding character should be matched. For example, the expression “\*” means “match zero or more spaces.”
3. Skip white space. The predefined UNIX regular expression “\ :b” is equivalent to “[ \t]+”, which requires that there be at least one space or tab.
4. Look for the “int” instruction as literal text.
5. Skip white space. The expression “[ \t]+” is equivalent to “\ :b”, and requires that there be one or more space or tab.
6. Skip optional “0” digits.
7. Look for a “2” digit as literal text.
8. Look for either a “0” digit or a “1” digit.
9. Look for an uppercase or lowercase “h” character.

This expression is so exact that it may take longer to write than the time it saves. The key to using regular expressions effectively is determining the minimal characteristics that make the text qualify as a match.

➔ **To find all int 20h and int 21h instructions:**

1. From the Search menu, choose Find.
2. In the Find Text box, type `^\ :bint\ :b2[01]`.
3. Select the Regular Expression check box.
4. Choose the Files button.
5. Add the pattern \*.ASM and the file \$INCLUDE:DOS.INC to the file list.
6. Choose OK to start the search.

When the search is complete, choose View Results. You can see in the Search Results window that PWB matched only the int 20h and int 21h instructions.

## Replacing Text

You can use regular expressions when changing text to achieve some extremely powerful results. A regular expression replacement can be a simple one-to-one replacement, or it can use “tagged” expressions. A tagged expression marks part of the matched text so that you can copy it into the replacement text.

For example, you can manipulate lists of files easily using regular expressions. This exercise shows how to get a clean list of files that is stripped of the size and time-stamp information.

→ **To get a clean list of .ASM files in the current directory:**

1. From the File menu, choose New.

This gives you a new file for the directory listing.

2. Execute the function sequence **Arg Arg !dir \* .ASM Paste**.

The default key sequence for this command is to press ALT+A twice, type `!dir * .asm`, then press SHIFT+INS.

**Arg Arg** introduces a text argument to the **Paste** function with an **Arg** count of two. The exclamation point (!) designates the text argument to be run as an operating-system command. Without the exclamation point, the text is the name of a file to be merged. If only one **Arg** is used, PWB inserts the text argument.

PWB runs the **DIR** command and captures the output. When the **DIR** command is complete, PWB prompts you to press a key. When you press a key, PWB then inserts the results of the command at the cursor. For more information about this and other forms of the **Paste** function, see “Paste” in Chapter 7, “Programmer’s WorkBench Reference.”

3. From the Search menu, choose Replace.
4. In the Find Text box, type `\ :b\ :z \ :z- . *$`

This pattern means:

- ◆ White space followed by
- ◆ A number followed by
- ◆ Exactly one space followed by
- ◆ A number followed by
- ◆ A dash (–) followed by
- ◆ Any sequence of characters, then
- ◆ End of the line

This string must be tied to the end of the line to prevent the search from finding anything too close to the beginning of the line.

5. Make sure there are no characters in the Replace Text text box.
6. Choose Replace All.

PWB prompts you to verify that you want to replace text with an empty string.

7. Choose OK to confirm that you want to perform the empty replacement.



All the file-size, date, and time-stamp information is removed. Because you did not reuse any of the original text in the replacement, this is a simple regular expression replacement.

Choose Close from the File menu to discard the text you created in the previous exercise.

A more complicated task is backing up the .ASM files to a directory called LAST, which is assumed to be a subdirectory of the current directory. A batch file makes this easier. You can create such a batch file using regular expressions.

➔ **To create a batch file that copies the .ASM files to a subdirectory:**

1. Create a list of .ASM files in the current directory as described in the previous example, but do not remove the file sizes, dates, and times.
2. Delete the heading printed by the **DIR** command.
3. From the Search menu, choose Replace.
4. In the Find Text text box, type `^\ ([^ ]+\) [ ]+\ ([^ ]+\) .*`
5. This expression finds a string that starts at the beginning of the line (^). Placing parts of the expression inside the delimiters \ ( and \ ) is called “tagging.”

The first tagged expression (`\ ([^ ]+\)`) matches one or more characters that are not spaces. A leading caret in a class means “not.”

The pattern then matches one or more spaces (`[ ]+`), followed by the second tagged expression which matches one or more characters that are not spaces.

The remainder of the line is matched by the wildcard (`.`), which matches any character, and the repeat operator (`*`). Matching the rest of the line is important because that is how this pattern removes everything after the filename. It discards these portions of the matched text.

6. In the Replace Text text box, type `COPY \1.\2 .\LAST`
7. Select Replace All and choose OK to begin the find-and-replace operation.

PWB transforms each directory entry into a command to copy the file to the LAST subdirectory.

```

File Edit Search Project Run Options Browse Window Help
=[ 1] Untitled.002
copy PAGER.ASM .\last
copy SHOW.ASM .\last
copy SHOWUTIL.ASM .\last
3 file(s) 33473 bytes
10078208 bytes free

3 occurrences replaced
< OK > < Help >

F1=Help Enter Esc=Cancel Tab=Next Field MP N 00001.001

```

The word COPY is inserted literally. The text matched in the first tagged expression (the base name) replaces the expression \1. The period is inserted literally. The text matched by the second tagged expression (the filename extension) replaces the expression \2. The space is inserted literally. The text . \LAST is inserted as . \LAST. Be sure to use two backslashes to indicate a literal backslash; otherwise, PWB expects a reference to a tagged expression such as \1 and displays an error message.

You'll notice that the last two lines of the file are not useful in your batch file. They are the remnants of the summary statistics produced by the **DIR** command. Delete these two lines and you have a finished batch file.

## Using the Source Browser

Another search technique is "browsing." Browsing uses information generated by the compiler to help you find pieces of code quickly. This section introduces you to some of the capabilities of the Source Browser. The browser is a handy tool for moving about in projects, large and small.

In addition to navigating through your program, you can use the browser to explore the relationships between parts of the project. The browser database contains full information about where each symbol is defined and used and about the relationships among modules, constants, macros, variables, functions, and classes. Note that the browser files can be very large.

## Creating a Browser Database

Before you can use the PWB Source Browser, you must build a browser database. PWB helps you maintain this database automatically as a part of a normal project build.

→ **To build a browser database:**

1. Open the SHOW project using the Open Project command from the Project menu (this project is located in the SAMPLES\SHOW subdirectory of your main MASM directory).
2. From the Options menu, choose Browse Options.  
PWB displays the Browse Options dialog box.

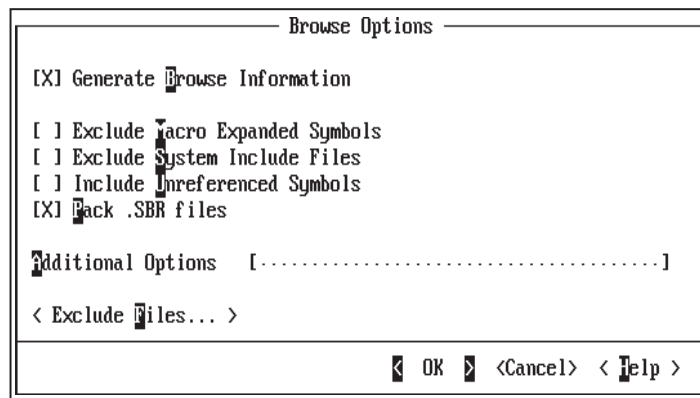

3. Select the Generate Browse Information check box.
4. Choose OK.

The browser changes the project makefile to build the project. It adds compiler options for creating browser information (.SBR files). It includes a BSCMAKE command which combines the .SBR files and creates a browser database (a .BSC file).

5. From the Project menu, choose Rebuild All.

Rebuilding the entire project ensures that the database contains up-to-date information for all files in your program.

When the build completes, the following new files are on your disk:

- ◆ SHOW.BSC, the browser database
- ◆ SHOWUTIL.SBR, a zero-length “placeholder” for the SHOWUTIL module.
- ◆ PAGER.SBR, a placeholder for PAGER.
- ◆ SHOW.SBR, a placeholder for SHOW.

After adding each .SBR file's contribution to the database, BSCMAKE truncates it and leaves the empty .SBR file on disk to provide an up-to-date target for later builds. Leaving these files on the disk ensures that a browser database is not rebuilt unless it is out of date with respect to its source files.

A PWB project is not required to create a browser database (although it is convenient). For information on how to build a browser database for non-PWB projects, see "Building Databases for Non-PWB Projects" on page 94.

## Finding Symbol Definitions

When you are working on a program, it's easy to forget where a particular variable, constant, or function is defined. You can use the Find command to locate occurrences of a symbol, but that offers little information about which one is the definition. To make such searches easier, you can choose Goto Definition from the Browse menu to jump directly to the definition of any symbol in your program.

The following procedure uses the SHOW project to demonstrate how powerful the browser can be.

➔ **To investigate the GetNamePos procedure:**

1. From the Window menu, choose Close All.
2. Open SHOW.ASM.
3. Go to line 174 (from the Search menu, choose Goto Mark, type 174, and press ENTER).
4. Move the cursor to the GetNamePos procedure.
5. From the Browse menu, choose Goto Definition.

PWB displays the Goto Definition dialog box.

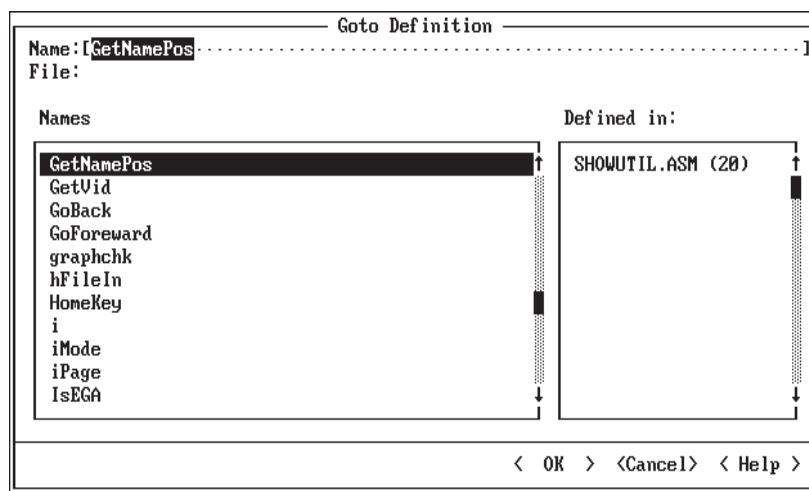

Notice that `GetNamePos` is highlighted and the defining file's name is displayed in the list box to the right. More than one defining file is listed if a name is defined in several scopes.

6. Choose OK.

PWB opens `SHOWUTIL.ASM` and shows the definition of `GetNamePos`.

## Showing the Call Tree

Often when analyzing an existing program's flow, or when looking for opportunities for optimization, it's useful to refer to a "call tree." A call tree is a view of your program that provides, for each function, a list of other functions called.

### → To generate a call tree of SHOW:

1. From the Browse menu, choose Call Tree.

PWB displays the Display Tree dialog box.

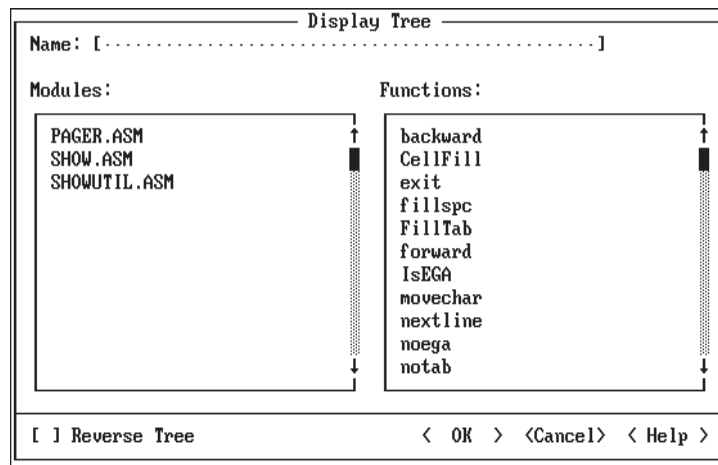

2. Choose `SHOW.ASM` from the Modules list box.

Notice that the Functions list box changes to show only the functions in `SHOW.ASM`.

3. Choose OK to see the call tree.

Three kinds of annotations appear in the call tree:

?

A symbol followed by a question mark is used by your program but not defined in any of the program files in the browse database. These are often library functions.

[*n*]

The number *n* between square brackets shows symbols that are used more than once. In the preceding example, `GetNamePos` is listed (under `SHOW.ASM`) as:

```
GetNamePos [ 3 ]
```

This means that there are three references to `GetNamePos` in `SHOW`.

... (ellipsis)

The ellipsis means that the full information for the function appears elsewhere in the call tree.

## Finding Unreferenced Symbols

As you write, rewrite and maintain a program, you will occasionally remove function calls or references to global variables, leaving unused code or data space in your program. Since the browser database contains information about where every function and variable is referenced, you can easily identify ones that are not used. This section shows how to use the Source Browser to find and remove the extra code and data.

The system include files define many more functions than most programs use. Therefore, unreferenced functions in your program are easiest to find when using a browser database that does not contain the system include files. This example begins by building a browser database for `SHOW` that does not contain information defined by system include files.

### ➔ To build the `SHOW` browser database:

1. From the Options menu, choose Browse Options.  
PWB displays the Browse Options dialog box.
2. In the Browse Options dialog box, select the Generate Browse Information, the Exclude System Include Files, and the Include Unreferenced Symbols check boxes.
3. Choose OK.

Now that the browse options are set, rebuild the project and browser database by choosing Rebuild All from the Project menu. With the updated browser database, you can obtain a list of references for functions and variables.

### ➔ To get a list of references for function and variables:

1. From the Browse menu, choose List References.  
PWB displays the List References dialog box.

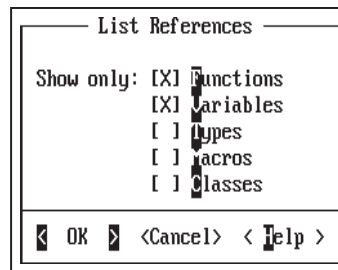

2. Select the Functions, Variables and Macros options, and then choose OK.

PWB opens the Browser Output window and creates the list of references. Each name is followed by a colon and a list of functions that refer to the name.

→ **To find an unreferenced symbol:**

- Search for the regular expression :\$ (colon, dollar sign).

This pattern specifies a colon at the end of the line. It finds names that are followed by an empty list of references.

In the list of references created above for SHOW, a search for this expression will find no matches, since there are no unreferenced symbols. To find all unreferenced items with one search, you can perform a logged search and add only <browse> (the Browser Output pseudofile) to the file list. This is especially useful for large projects.

→ **To go to the definition of an unreferenced symbol in the source:**

1. Place the cursor on the symbol in question. From the Browse menu, choose Goto Definition.

PWB automatically selects the definition of the symbol under the cursor. However, if the symbol begins with “@” or “?” or other punctuation characters, the nonalphabetic character is not automatically recognized as part of the symbol name. To include it, mark the entire name before choosing Goto Definition.

2. Choose OK.

PWB jumps to the definition of the selected symbol in the appropriate source file, where you can remove the unused function, macro or variable.

## Advanced Browser Database Information

In the previous sections, you learned the basics of building a browser database and some useful applications of the Source Browser. In this section, you will find information on what goes into a browser database and how to estimate the disk

requirements to build one. You will also learn how to build a database for non-PWB projects and how to build a single database for related projects.

### Estimating .SBR and .BSC File Size

When you build a browser database, you first create an .SBR file for each source file in the project. Each of these files contains the following information:

- ◆ The name of the source file and the files it includes.
- ◆ Every symbol defined in the source file and the files it includes.

These symbols are the names of all functions, types (including the names of all classes, structures, and enumerations and their members), macros (including symbols in the expanded macro), and variables in the file. These symbols also include all parameters and local variables for the functions.
- ◆ The location of all symbol definitions in the files.
- ◆ The location of all references to every symbol in the files.
- ◆ Linkage information.

This is a tremendous amount of information about your program and can therefore occupy a large quantity of disk space. The benefit is that the Source Browser provides fast, sophisticated access to this database of knowledge about your program.

For assembler source files, the .SBR file may be between a quarter and a half the size of the preprocessed source file (that is, the source file with comments removed, all files included, and all macros expanded).

You might assume that the resulting browser database (.BSC file) is approximately the sum of all the .SBR files. However, the browser database is the *union* of the information in the component .SBR files. This means that the .BSC file is usually not very large. Much of the information in the .SBR files is defined in include files, which are common to many modules in the project. The union of the .SBR files is relatively small because most of the include-file information is duplicated in each .SBR file.

Even for C or C++ programs, which tend to create much larger .BSC files, a good-sized program will seldom require a .BSC file larger than 500K.

### Building Databases for Non-PWB Projects

The simplest way to build a browser database for non-PWB projects is to build the browser database separately from the project. You can use a makefile or a batch file for this purpose. The process requires only two steps:

1. Create an .SBR file for each module. The simplest way to do this is to run the compiler with the options to produce an .SBR file and no other files. For example, the ML command line:



```
ML /Zs /W0 /Fr *.asm
```

specifies that the compiler processes all .ASM files in the current directory, checks syntax only (/Zs) and issues no warnings (/W0). Therefore, no object files are produced. However, browser information (.SBR files) are generated (/Fr).

2. Combine the .SBR files into a browser database.

The syntax for this command is:

```
BSCMAKE options loproject.BSC *.sbr
```

For complete information on BSCMAKE options and syntax, see Chapter 19.

The process of creating a browser database changes little between projects. Therefore, you could use a batch file for many projects similar to the following example:

```
ECHO OFF
REM Require at least one command-line option
IF %1.==. GOTO USAGE

REM Compile to generate only .SBR files
ML /Zs /W0 /Fr *.asm

REM Build the browser database
BSCMAKE %2 %3 %4 %5 %6 %7 %8 /o%1.BSC *.sbr
GOTO END

:USAGE
REM Print instructions
ECHO -Usage: %0 project [option]...
ECHO -    project      Base name of browser database
ECHO -    [option]...  List of BSCMAKE options
:END
```

This batch file assumes that all the project sources are in the current directory. It requires that you specify the name of the browser database and allows BSCMAKE options. You may want to change this file to specify different BSCMAKE or assembler options.

If your project's sources are distributed across several directories, you must write a custom batch file or makefile to build the database. For more information on the BSCMAKE utility, see Chapter 19.

➔ **To use a custom browser database in PWB:**

1. From the Browse menu, choose Open Custom.
2. Choose the Use Custom Database button.

3. Select your custom browser database and choose OK.

If you want to save this database name permanently, choose Save Current Database.

4. Choose OK.

The PWB Source Browser opens your custom database.

You can now browse your non-PWB project.

If you are using a makefile to build your project, you can choose Open Project from the Project menu and open it as a non-PWB project makefile. If the project makefile has the same base name as the browser database and resides in the same directory, PWB automatically opens the database when you open the project. For more information on using a non-PWB makefile for a project in PWB, see “Using a Non-PWB Makefile” on page 55.

### Building Combined Databases

If you have two or more closely related projects, you can combine the browser databases for the projects. For example, if two large programs differ only in one or two modules so that most of the sources are shared between the two projects, it can be useful to browse both projects with a single browser database.

➔ **To build a combined browser database:**

1. Generate the .SBR files for both projects.
2. Pass all of the .SBR files to BSCMAKE to build the combined database.

The resulting database is the inclusive-OR of the information in the two projects.

## Executing Functions and Macros

The menus and dialog boxes in PWB provide access to almost everything you need to do to develop your projects. You can edit, search, and browse your source files. You can build, run, and debug your project, and you can view Help for the entire system. However, the visible display provides access to only part of the capabilities available in PWB. Behind the menu commands lie functions with many more options than you can access from the menus. Many functions and macros are not assigned to keys by default.

The sophisticated PWB user learns how to use the functions and predefined macros to perform the precisely correct action. Each function has several forms that are invoked with the combinations of the **Arg** and **Meta** prefixes. These two functions are used to introduce arguments and modify the action of PWB functions.

**Arg** (ALT+A)

The fundamental function in PWB. You use **Arg** to begin selecting text, introduce text and numeric function arguments, or modify the action of functions by increasing the Arg count.

To pass a text argument to a function, for example, press ALT+A, and then type the text. The text you type doesn't go into your file. The Text Argument dialog box appears when you type the first letter of the text.

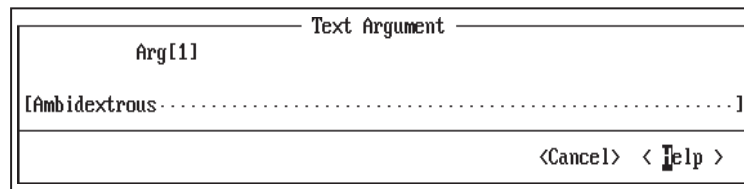

You can then edit the text. PWB displays the current argument count and Meta state in the dialog box.

Notice that there is no OK button in this dialog box. Instead of choosing OK, press the key for the function you want to execute with this argument. Choose the Cancel button if you do not want to execute a function.

**Meta** (F9)

Modifies the action of a function in different ways from the various argument types. It generally toggles an aspect of the function's action.

For example, the text-deletion functions usually move the deleted text to the clipboard. However, when modified with **Meta**, they clear the text without changing the clipboard.

The combination of **Arg** and **Meta** greatly increases the number of variations available to each function. For example, the **Psearch** function can perform different search operations depending on how it is executed. **Psearch** can:

- ◆ Repeat the previous search (**Psearch**).
- ◆ Search for text (**Arg text Psearch**).
- ◆ Perform a case-sensitive text search (**Arg Meta text Psearch**).
- ◆ Search for a regular expression (**Arg Arg text Psearch**).
- ◆ Search for a case-sensitive regular expression (**Arg Arg Meta text Psearch**).

Because you can reassign keys to your preference, the PWB documentation cannot assume that a specific key executes a given function or macro. Therefore, the PWB documentation gives a sequence of functions or macros by name, followed by the same sequence of actions by key name. In this book, the key is the default key. In PWB Help, the displayed key is the one currently assigned to that function. When no key is assigned, PWB displays *unassigned*.

For example, to insert the definition of a macro at the cursor, you pass the name of the macro to the **Tell** function and modify **Tell**'s action with the **Meta** prefix. This sequence of actions is expressed as follows:

- ◆ Execute the function sequence **Arg Meta macroname Tell**  
(ALT+A F9 *macroname* CTRL+T).

If the **Tell** function is assigned to a different key, Help displays that key in place of CTRL+T.

Chapter 7, “Programmer’s WorkBench Reference,” contains complete descriptions of all forms of each function in PWB.

## Executing Functions and Macros by Name

The most frequently used functions and macros are assigned to certain keys by default. For example, the **Paste** function is assigned to SHIFT+ENTER, **Linsert** is assigned to CTRL+N, and so on. Sometimes, however, you want to use a function or macro that is not assigned to a key. You can always assign a key by using the Key Assignments command or by using the **Assign** function. However, that is a lot of trouble for something you need only once. PWB allows you to execute a function or macro by name, rather than by pressing a key.

➔ **To execute a function or macro by name:**

- Perform the function sequence **Arg function Execute** (ALT+A *function* F7).

In other words, press ALT+A (execute the **Arg** function), type the name of the function or macro, and then press F7 (invoke the **Execute** function).

The argument to **Execute** doesn’t have to be a single function or macro name. It can be a list of functions and macros. The argument is really a temporary, nameless macro. This means that you can do anything in an argument to **Execute** that you can do in a macro. PWB follows the rules for macro syntax and execution. You can define labels, test function results, and loop.

---

**Warning** When executed from a macro, PWB functions that display a yes-or-no prompt assume a “Yes” response. To restore the prompt, use the macro prompt directive (<). For more information, see “Macro Prompt Directives” in PWB Help.

---

## Writing PWB Macros

The Programmer’s WorkBench, like other editors designed for programmers, provides a macro language so that you can customize and extend the editor or automate common tasks. You can create macros in one of the following ways:

- ◆ By recording actions you perform. The recording mechanism allows you to perform a procedure once, while PWB is recording. After you've recorded it, you can execute the macro to repeat the recorded procedure.
- ◆ By manually writing macros. This technique is less automatic but does allow you to write more powerful macros.

These two techniques are not mutually exclusive. You can start by recording a macro that approaches the steps you want to perform, then edit it to expand its functionality or handle different situations.

## When Is a Macro Useful?

Macros are useful for automating procedures you perform frequently. You may also write macros that automate tedious one-time tasks.

Of course, not every task is a good candidate for automation. It might take longer to write the macro than to do the task by hand. If you don't expect to perform a task often, don't automate it. Also, automated editing procedures introduce an element of risk. You might not foresee situations that your macro can encounter. Incorrect macros can sometimes be destructive.

A little experience with macros and some careful testing will enable you to create a good set of macros for your own use.

## Recording Macros

Recording actions you perform with the mouse or at the keyboard can be a powerful way to write a macro. You turn on recording and perform the actions that you want the macro to execute. You can concentrate on the task that you want to automate, instead of concentrating on the syntax of the macro language.

For example, if you occasionally reverse characters when you type quickly, a macro to transpose them is useful. Before recording a macro to transpose characters, you should think about what you are going to do while recording the macro. To transpose characters, you will select the character at the cursor, cut it onto the clipboard, move over one character, and then paste the character you cut.

➔ **To record a macro that transposes characters:**

1. From the Edit menu, choose Set Record.  
PWB brings up the Set Macro Record dialog box.

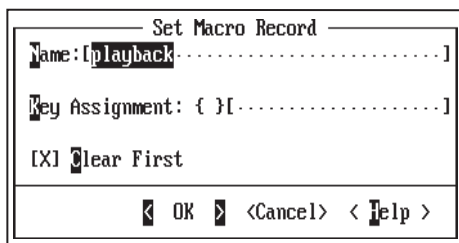

2. In the Name text box, type Transpose.
3. Click the mouse in the key box (between the braces { }), or press TAB until the cursor is in the key box.
4. Press CTRL+SHIFT+T (for transpose).  
PWB automatically fills in the name of the key you pressed.

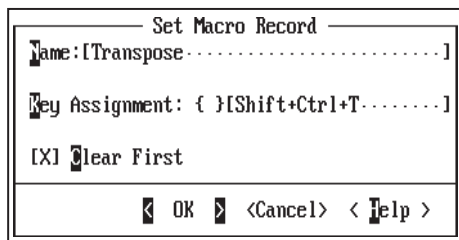

5. Press TAB to leave the key box, and then choose OK.  
PWB closes the Set Macro Record dialog box. When you turn on macro recording, PWB records a macro called Transpose and associates it with SHIFT+CTRL+T.

---

**Important** The Set Macro Record command does *not* start the macro recorder. It only specifies the name and key association for the macro you are going to record.

---

6. From the Edit menu, choose Record On.  
When you choose Record On, the macro recorder starts. To indicate that the macro recorder is running, PWB displays the letter x on the status bar. Notice that the Project, Options, and Help menus are unavailable while PWB is recording a macro.
7. Select the character at the cursor by holding down the SHIFT key and pressing the RIGHT ARROW key.
8. Press SHIFT+DEL to cut the character onto the clipboard.
9. Press the RIGHT ARROW key to move the cursor to the new location for the character.

10. Press SHIFT+INS to paste the character from the clipboard back into the text.
11. From the Edit menu, choose Record On to stop the macro recorder.

Press SHIFT+CTRL+T to switch the character at the cursor with the character to the right. You can now use the new macro and key assignment for the rest of the PWB session.

→ **To edit the macro:**

- From the Window menu, choose Record from the PWB Windows cascaded menu.

PWB opens the Record window.

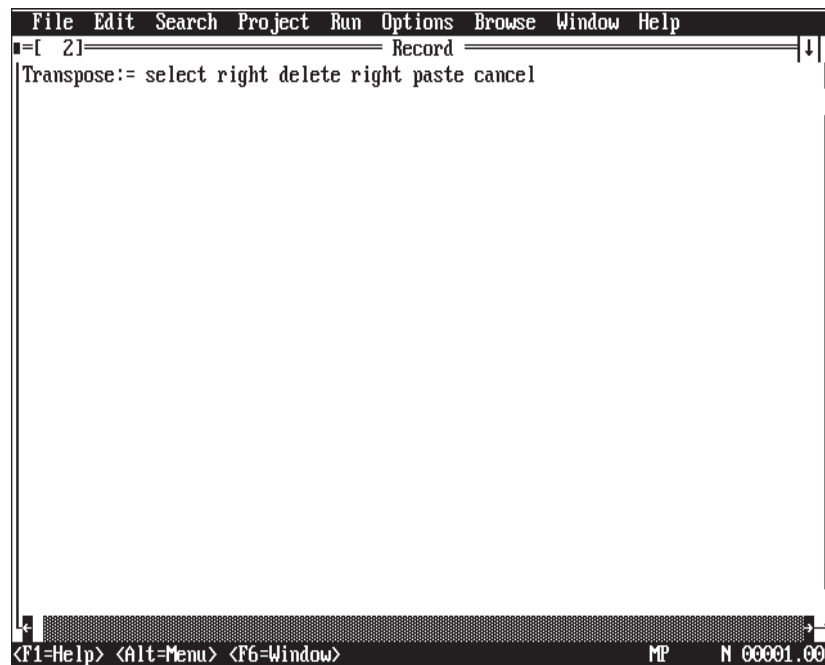

The Record window shows the definition of the `Transpose` macro that you just recorded. You can edit the definition to change the way the macro works. For example, you decide that the macro should reverse the character at the cursor with the character to the left, instead of the character to the right.

→ **To redefine the macro:**

1. Change the macro to read as follows:

```
Transpose:=select left delete left paste
```

2. Move the cursor to the macro definition.

3. Press ALT+=, the default key for the **Assign** function.  
Assigning the macro replaces the previous definition of `Transpose` with the new definition.
4. Return to the file you were originally viewing.

Up to this point, the macro exists only in memory. To use your recorded macro for subsequent PWB sessions, you must save the definition of the macro to disk.

→ **To save the macro:**

1. If the Record window is not open, choose Record from the PWB Windows cascaded menu.  
PWB opens the Record window.
2. From the File menu, choose Save.  
PWB inserts the macro definition and the key assignment into your `TOOLS.INI` file for future sessions. When you leave PWB, you are prompted to save `TOOLS.INI`. Your changes are not permanent until you actually save `TOOLS.INI`.

## Flow Control Statements

Recorded macros have the inherent limitation of playing back one fixed sequence of commands. Often you need a macro to execute repeatedly until some condition is satisfied. This requires that you use flow control statements to govern the actions your macro takes.

All editor functions return a true or false value. The macro flow control operators that use these values are:

Operator	Meaning
<code>+&gt;label</code>	Branch to <i>label</i> if last function yields TRUE
<code>-&gt;label</code>	Branch to <i>label</i> if last function yields FALSE
<code>=&gt;label</code>	Branch unconditionally to <i>label</i>
<code>:&gt;label</code>	Define <i>label</i>

These rudimentary operators are not as sophisticated as a high-level language's IF statement or FOR loop. They are more like an assembly language's conditional jump instruction. However, they provide the essential capabilities needed for writing loops and other conditional constructs.

## Flow Control Example

If you frequently perform multiple-window editing, a macro that restores the display to a single window can be helpful. Such a macro requires the following logic:



1. Switch to the next window.
2. If the switch is not successful (meaning that only one window is present), end the macro.
3. If the switch is successful (another window is present), close that window and go back to step one.

This macro will be called CloseWindows and assigned to SHIFT+CTRL+W.

→ **To create the CloseWindows macro:**

1. From the File menu, choose All Files.

PWB displays the All Files dialog box.

Notice that your TOOLS.INI file is in the list of open files, even though you did not explicitly open it. PWB opens TOOLS.INI to load its configuration information (unless when you specify /DT on the PWB command line).

2. Select TOOLS.INI file in the list of open files.
3. Choose OK.

PWB opens a window and displays your TOOLS.INI file.

4. Find the section of TOOLS.INI that begins with [pwb]. This is the section where PWB keeps its startup configuration information.
5. In the PWB section, type the following two new lines:

```
CloseWindows:= :>Loop Openfile -> Meta Window Window =>Loop
CloseWindows: SHIFT+CTRL+W
```

If you want these definitions to take effect immediately, select both lines and press ALT+= to execute the Assign function. You can also assign the definitions one at a time.

6. Choose Save from the File menu to make this macro and key assignment part of your TOOLS.INI file.

The next time you start PWB, the CloseWindows macro is defined and assigned to the SHIFT+CTRL+W key.

The first line you typed uses the := operator to associate the macro definition with the name "CloseWindows." After the operator is the list of functions and macro operators that specify what the macro is to do. The second line is a separate statement that uses the : operator to assign the macro to the SHIFT+CTRL+W key.

The CloseWindows macro works as follows:

1. LOOP defines a label called LOOP. There cannot be a space between the :> operator and the label name.

2. `Openfile` switches to the window under the active window.
3. The `->` operator examines the return value from the **Openfile** function. If the function returns false because there is no other window, the `->` operator exits the macro.
4. The phrase `Meta Window` closes the active window.
5. `Window` returns to the window you started from.
6. `Loop` unconditionally transfers control back to the `Loop` label and starts the sequence again.

When this macro is defined, you can press `SHIFT+CTRL+W` whenever you want to close all windows except the active window.

## User Input Statements

PWB macros can prompt for input. This helps you write more general macros. For example, you might keep a history of the changes you make to a file at the top in a format similar to the following:

```
/** Revision History **  
//15-Nov-1991:IAD:Add return value for DoPrint  
//31-Oct-1991:IAD:Implement printing primitives
```

To facilitate entering the revision history in reverse chronological order and to make it easy to keep track of where you were in the source file, you can write a macro to perform the following steps:

1. Set a mark at the cursor for future reference.
2. Insert a revision history header at the beginning of the file if one is not present.
3. Insert the current date.
4. Prompt for initials and insert them just below the header.
5. Prompt for comments and insert them after the initials.
6. Return to the saved position in the file.

Note that while this macro is executing, you can choose the **Cancel** button in the dialog boxes that prompt for initials and comments. The macro must handle these cases and gracefully back out of the changes to the file.

➔ **To enter this macro in TOOLS.INI:**

1. Open `TOOLS.INI` for editing.
2. Type the following macros and key assignment in the `[pwb]` section of `TOOLS.INI`:

```

LineComment:= "// "
RevHead:= "*** Revision History ***"
RevComment:= \
  Arg Arg "Start" Mark \
  Begfile Arg RevHead Psearch +>Found \
  Linsert LineComment RevHead \
:>Found \
  Down Linsert Begline LineComment Curdate " (" \
  Arg "Initials" Prompt ->Quit Paste Endline ") " \
  Arg "Comment" Prompt ->Quit Paste =>End \
:>Quit Meta Ldelete \
:>End Arg "Start" Mark
RevComment:Ctrl+H

```

There are at least two spaces before the backslash at the end of each line. The backslashes are line-continuation characters. They allow you to write a macro that is more than one line long. In this case, line continuations format the macro in a readable way. To further assist in readability, you can indent the parts of the macro which define the actual keystrokes, as in the preceding example.

3. Choose Save from the File menu to save your changes.
4. To reinitialize PWB, execute the **Initialize** function by pressing SHIFT+F8. PWB discards all of its current settings and rereads the PWB section of TOOLS.INI. The same effect can be achieved by quitting and restarting PWB.

The following discussion analyzes the workings of the definitions you added to TOOLS.INI. It repeats one or two lines from the text you typed and describes how each line works. You may want to refer to the full definition as you follow along.

#### The first two lines

```

LineComment:= "// "
RevHead:= "*** Revision History ***"

```

define two utility macros that are used by the main RevComment macro. They define strings that are used several times in RevComment.

#### The third line

```

RevComment:= \

```

declares the name of the macro. The succeeding lines define the action of the RevComment macro.

The first line of the definition

```
Arg Arg "Start" Mark \
```

sets a mark named “Start” at the cursor so that the macro can restore the cursor position after inserting the comments at the beginning of the file.

The next line

```
Begfile Arg RevHead Psearch +>Found \
```

moves to the beginning of the file (**Begfile**), then searches forward for the revision-history header. If the header is found, PWB branches to the `Found` label; otherwise, it executes the next line.

```
Linsert LineComment RevHead \
```

If the macro is here, the header was not located in the file. The **Linsert** function creates a new line, and PWB types the revision-history header. The macro continues with the line:

```
:>Found \
```

This line defines the `Found` label. At this point in the macro, the cursor is on the line with the header. The next lines insert the new revision information, starting with the following line:

```
Down Linsert Begline LineComment Curdate " (" \
```

PWB moves the cursor down one line (**Down**), inserts a new line (**Linsert**), moves to the beginning of the line (**Begline**), and calls the `LineComment` macro to designate the line as a comment. PWB then types the current date (**Curdate**) and an open parenthesis.

The macro prompts for initials:

```
Arg "Initials" Prompt ->Quit Paste Endline ") " \
```

The macro uses the **Prompt** function to get your initials. If you choose the Cancel button, the function returns false, so the macro branches to the label `Quit`. If you choose the OK button, the text you typed in the dialog box is passed to the **Paste** function, which inserts the text. The macro moves the cursor to the end of the line (**Endline**) and types a closing parenthesis.

The code on this line explicitly handles the case when you cancel the prompt (the false condition). The phrase `->Quit` causes PWB to skip to the label `Quit` when **Prompt** returns false.

If you use the **Prompt** function and you do not handle the false condition, a null argument (a text string with zero length) is passed to the next function. Therefore, a

phrase like `Arg "Que?" Prompt Paste` pastes either the input or nothing, depending on whether you choose the OK or Cancel button. Passing a null argument to **Paste** is harmless, but some functions require an argument. In these cases, you can use the `->` operator to terminate the macro.

The `RevComment` macro uses an explicit label so that it can end the macro without an error when you choose the Cancel button. The next line of the macro is almost the same as the previous line in the macro.

```
Arg "Comment" Prompt ->Quit Paste =>End \
```

On this line, if the paste is carried out, an unconditional branch is taken to the label `End` and passes over the `Quit` branch, which is defined on the next line.

```
:>Quit Meta Ldelete \
```

The `Quit` branch is taken when you cancel a prompt. The macro has to clean up the text already inserted by the macro. The **Meta Ldelete** function deletes the incomplete line that would have been the revision-history entry. The next line defines the last step of the macro.

```
:>End Arg "Start" Mark
```

The `End` label defines the entry point for the common cleanup code. This line restores the cursor to the initial position when you invoked the macro. Because this line does not end in a line-continuation character (`\`), it is the end of the `RevComment` macro.

The last line that you typed is not part of the `RevComment` macro. It is a separate `TOOLS.INI` entry.

```
RevComment:Ctrl+H
```

This line assigns the `CTRL+H` key to the `RevComment` macro.

You can polish this macro by adding `Arg "Start" Meta Mark` to the end of the macro. This phrase deletes the mark. A better alternative is to use the **Savecur** and **Restcur** functions instead of named marks. However, this example uses named marks to illustrate how to use them in a macro.



## CHAPTER 6

## Customizing PWB

PWB is a completely customizable development environment. You can modify PWB in the following ways:

- ◆ Changing mapping of keystrokes to actions.
- ◆ Changing default behavior of PWB (for example, how tabs are handled or if PWB automatically saves files).
- ◆ Changing the colors of parts of the PWB display.
- ◆ Adding new commands to the Run menu.
- ◆ Programming new editor actions (macros).

Instructions on how to write macros are in “Writing PWB Macros” on page 98.

In addition to the customizations that you can make by using the commands in the Options menu, you can also customize PWB by editing the TOOLS.INI file.

---

**Note** Another category of customization that is not covered in this book is how to write PWB extensions. An extension is a dynamically loaded module that can access PWB’s internal functions. Extensions can do much more than macros. To learn more about writing PWB extensions, see the Microsoft Advisor Help system (choose “PWB Extensions” from the main Help table of contents).

---

## Changing Key Assignments

PWB maps actions (functions and macros) to keys. You can assign any of these actions to keys other than the default keys.

For example, **Exit** is a PWB function. Its default key assignment is F8. A BRIEF user may prefer to use ALT+X to leave the editor.

→ **To make ALT+X execute the Exit function:**

1. From the Options menu, choose Key Assignments.

PWB displays the Key Assignments dialog box.

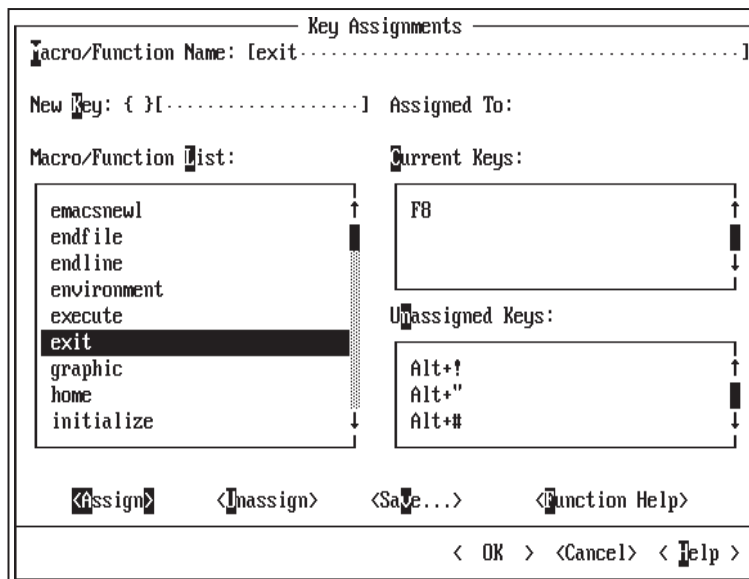

2. Select Exit in the Macro/Function List box, or type `exit` in the Macro/Function Name text box.
3. Move the cursor to the New Key box between the braces ({} ) by clicking between the braces or by pressing ALT+K.
4. Press ALT+X.

PWB types ALT+X in the text box after the braces and displays the name of the macro or function that ALT+X is currently assigned to. With the default settings, you can see that ALT+X is assigned to the **Unassigned** function. Pressing a key in the key box is a quick way to find out the name of the function assigned to the key.

---

**Note** When the cursor is in the key box (between the braces), most keys lose their usual meaning, including ESC, F1, and the dialog box access keys. The key you press is interpreted as the key to be assigned. Only TAB, SHIFT+TAB, ENTER, and NUMENTER retain their usual meaning. To assign one of these keys, type the name of the key in the text box.

---

5. Press TAB to move the cursor out of the key box.
6. Choose Assign.

PWB assigns Exit to the ALT+X key. Note that Exit is still assigned to the F8 key. Functions can be assigned to many keys.

7. Choose OK.



---

**Important** To change a key, you *must* choose the Assign button. The OK button dismisses only the dialog box. It does not perform any other action. This design allows you to assign many keys in one session with the dialog box.

---

The change remains in effect for the duration of the session.

→ **To make a permanent key assignment:**

1. From the Options menu, choose Key Assignments.
2. Choose Save.

PWB displays the Save Key Assignments dialog box, which lists all of the unsaved assignments that you have made during the PWB session by using the Key Assignments dialog box.

3. Delete any settings that you do not want to save.
4. Choose OK.

PWB writes your new settings into the [PWB] section of TOOLS.INI for subsequent sessions. When you exit PWB, you are prompted to save TOOLS.INI. Your changes are not permanent until you actually save the file to disk.

If you already know the function name, you can make a quick assignment for the current session by using the **Assign** function instead of going through the Key Assignments dialog box.

→ **To assign a key using the Assign function:**

- Execute the function sequence:

**Arg** *function:key* **Assign** (ALT+A *function :key* ALT+=).

For example, to assign **Exit** to ALT+X:

1. Press ALT+A to execute **Arg**.
2. Type `exit:ALT+X`
3. Press ALT+= to execute **Assign**.

The assignment is in effect for the rest of the PWB session.

The key assignments you make by using the **Assign** function are not listed in the Save Key Assignments dialog box.

To discover the name of the function or macro that is currently assigned to a key, use the Key Assignments dialog box (as previously described) or use the **Tell** function.

→ **To find a current key assignment using Tell:**

1. Press CTRL+T to execute **Tell**.

PWB displays the prompt:

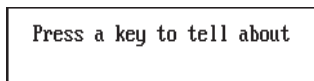

Press a key to tell about

2. Press the key you want to find out about.

If you press F10, PWB displays the function assigned to the F10 key (Openfile).

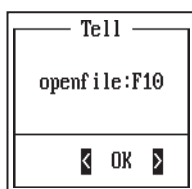

Tell

open file:F10

OK

The **Tell** function has many other uses in addition to displaying key assignments. For more information on **Tell**, see page 202.

## Changing Settings

When you first use PWB, you don't have to specify the tab stops, whether the editor starts in insert or overwrite mode, and so on. These settings (called "switches") are all covered by defaults. PWB's default behavior can be extensively customized by changing the values of PWB switches.

Switches fall into three categories:

- ◆ Boolean switches. True/false or on/off switches that can also be specified as yes/no or 0/1. An example of a Boolean switch is **Autosave**, which governs whether PWB saves a file when you switch to a different one.
- ◆ Numeric switches. An example of a numeric switch is **Undocount**, which determines the maximum number of editing actions you can undo.
- ◆ Text switches. Examples of a text switch are **Markfile**, the name of the file in which to store marks, **Tabstops**, a list of tab-stop intervals, and **Readonly**, the operating-system command for PWB to run when saving a read-only file.

→ **To change the setting for Tabstops:**

1. From the Options menu, choose Editor Settings.

PWB displays the Editor Settings dialog box.

2. **Tabstops** is a text switch (not a numeric switch as you might expect), so select the Text option button.

3. Select **Tabstops** in the Switch List box.

PWB shows the current setting for **Tabstops** in the Switch text box at the top of the dialog box.

4. Move to the Switch text box by clicking in the box or by pressing ALT+S.

PWB selects only the switch value, instead of the entire text.

5. Type the new setting:

3 4 7 8

This setting defines a tab stop at columns 4, 8, 15, and every eight columns thereafter. At this point, the Editor Settings dialog box should look like:

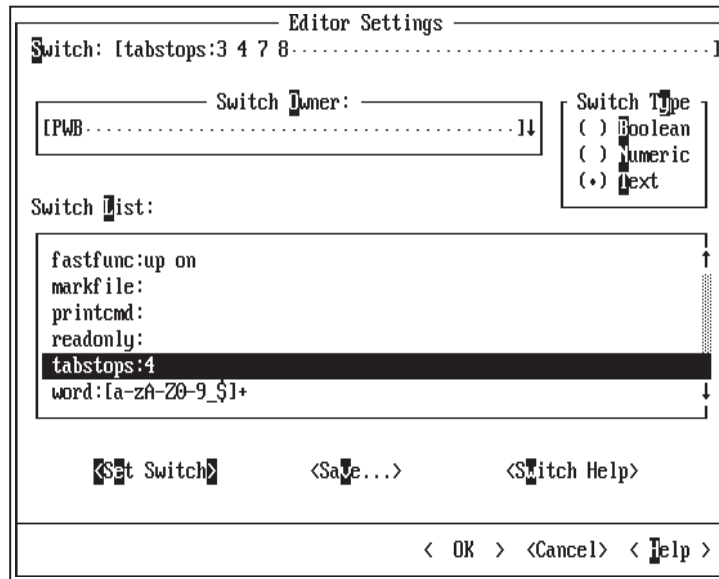

6. Choose the Set Switch button to change the setting of the **Tabstops** switch.
7. Choose OK.

---

**Important** To change a setting you *must* choose the Set Switch button. The OK button only dismisses the dialog box. It does not perform any other action. This design allows you to set many switches in one session with the dialog box.

---

The new tab stops you set are used for the current session. If you want to use this setting permanently, you must choose the Save button in the Editor Settings dialog box. This changes your TOOLS.INI file in the same way as for key assignments.

You can make temporary switch assignments for the current session by using the **Assign** function. You do this in the same way as for a key assignment by typing **Arg switch :value Assign** (ALT+A *switch:value* ALT+=).

You may be curious about the Switch Owner box that you did not use in this example. The Switch Owner is either PWB or a PWB extension such as PWBHELP (the extension that provides the Microsoft Advisor in PWB). Type or select a switch owner to set switches for that extension. Each extension has its own section in TOOLS.INI.

---

**Note** When you choose Set Switch, most switch settings take effect immediately. However, changes to the **Height** switch do not take effect until you choose OK.

---

## Customizing Colors

You can change the color of almost any item in the PWB interface. For a table showing the names and meanings of PWB's color settings, see page 252 in Chapter 7, the "Programmer's WorkBench Reference."

Some displays show a brilliant green for the left and right triangular symbols surrounding buttons in Help.

- **To change the light green to light cyan:**
1. From the Options menu, choose Colors.  
PWB displays the Colors dialog box.

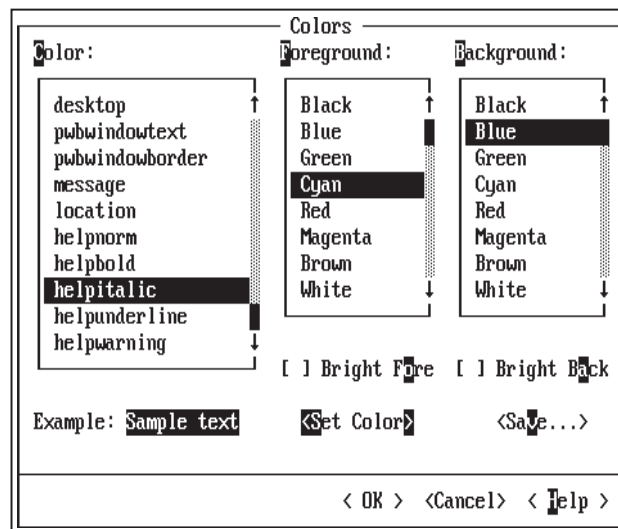

2. Select **Helpitalic** in the Color list box.
3. Select Cyan in the Foreground list box.
4. Choose Set Color.

To verify your change, press F1. The green symbols in help are now light cyan blue. While you are viewing Help, you can find out what parts of PWB the rest of the color names determine. To leave Help, choose the Cancel button or press ESC. PWB returns you to the Colors dialog box.

The Bright Fore and Bright Back check boxes determine if the given color is the usual version of the color or the bright version of the color. Bright black, for example, is usually a dark gray color.

If you want to save your new colors for subsequent sessions, choose the Save button. PWB displays the Save Colors dialog box where you can delete modifications that you don't want to save. When you choose OK in the Save Colors dialog box, PWB modifies TOOLS.INI to record your changes.

## Adding Commands to the Run Menu

You can add up to six commands to the Run menu to integrate your own utilities into PWB. A command is the name of any executable (.EXE or .COM) file, batch (.BAT) file, or built-in operating-system command such as DIR or COPY.

Suppose you use an outline processor to keep project notes. You can start the outline processor from PWB's Run menu.

→ **To add a command to the Run menu:**

1. From the Run menu, choose Customize Run Menu.
2. Choose the Add button.

PWB displays the Add Custom Run Menu Item dialog box for you to describe your custom menu item:

3. Type `Project ~Notes...` in the Menu Text box.

The tilde (~) before the letter N indicates the highlighted access letter for the menu command. The ellipsis (...) uses the standard convention to indicate that the command will require more information before it is completed. An ellipsis is commonly associated with a dialog box command but can be used in this context as well.

4. Specify the full path to the outlining program, `OUTLINE.EXE`, in the Path Name text box. (The program name `OUTLINE.EXE` is for example purposes only. Substitute the name of your own outliner or other program in its place.)
5. Specify the arguments you want to pass to the outliner in the Arguments text box: `%|dpfF.log`.

This example illustrates a powerful feature of PWB: its ability to extract parts of the filename to form a new name for customized menu items. The specification `%|dpfF` extracts the drive (d), path (p), and base name (F) of the current file. Anything after F is added to the end of the name.

For example, if the current file is `C:\SOURCE\COUNT.ASM`, the argument that PWB passes to the program is `C:\SOURCE\COUNT.LOG`.

6. In the Help Line text box, type the explanatory message that appears on the status bar when you browse this menu item:

Run the OUTLINE program

7. Choose OK to confirm your entries.

PWB adds the command to your Run menu and modifies TOOLS.INI to save the new item. You can now access your outline processor directly from the Run menu.



---

**Note** You can add other text processing or word processing programs to the Run menu. If you change the current file using another program, PWB prompts you to update the file or to ignore the changes made by the other program.

---

## How PWB Handles Tabs

The following functions and switches control how PWB handles tabs:

Name	Type	Description
<b>Realtabs</b>	Switch	Determines if PWB preserves tabs on modified lines
<b>Entab</b>	Switch	The white space translation method
<b>Tabalign</b>	Switch	The alignment of the cursor within a tab field
<b>Filetab</b>	Switch	The width of a tab field
<b>Tabdisp</b>	Switch	The fill-character for displaying tab fields
<b>Tab</b>	Function	Moves the cursor to the next tab stop
<b>Backtab</b>	Function	Moves the cursor to the previous tab stop
<b>Tabstops</b>	Switch	Tab positions for Tab and Backtab

For detailed information on each function and switch, see Help or Chapter 7, “Programmer’s WorkBench Reference.” For instructions on how to set a switch see “Changing Settings” on page 112. For instructions on how to assign a function to a key, see “Changing Key Assignments” on page 109.

To understand how PWB handles tabs, you need to know only a few facts:

- ◆ The **Tab** (TAB) and **Backtab** (SHIFT+TAB) cursor-movement functions and the **Tabstops** switch have nothing to do with tab characters. They affect cursor movement, rather than the handling of tab characters, and are not discussed further here. For more information on these items, see Chapter 7, “Programmer’s WorkBench Reference.”
- ◆ PWB never changes any line in your file unless you explicitly modify it (lines longer than PWB’s limit of 250 characters are the exception).  
Some text editors translate white space (that is, entab or detab) when they read and write the file. PWB does not translate white space when it reads or writes a file. This is to be compatible with source-code control systems that would detect the translated lines as changed lines.
- ◆ PWB translates white space according to the **Entab** switch only when you modify a line.
- ◆ **Tabalign** has an effect only when **Realtabs** is set to yes.
- ◆ A “tab break” occurs every **Filetab** columns.
- ◆ When PWB displays a tab in the file, it fills from the tab character to the next tab break with the **Tabdisp** character.

Figure 6.1 illustrates how PWB displays tabs.



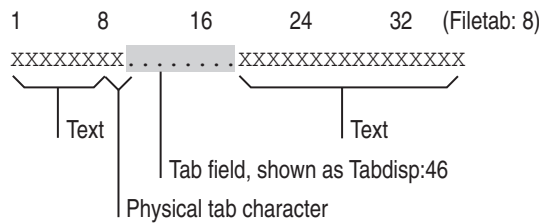

**Figure 6.1 How PWB Displays Tabs**

- ◆ When translating white space, PWB preserves the exact spacing of text as it is displayed on screen.

To set the width of displayed tabs, change the setting of the **Filetab** switch.

To tell PWB to translate white space on lines that you modify, set the **Realtabs** switch to `no` and the **Entab** switch to a nonzero value, according to the translation method that you want to use. The **Entab** switch takes one of the following values:

<b>Entab</b>	<b>Translation Method</b>
0	Translate white space to space characters
1	Translate white space outside of quotation-mark pairs to tabs
2	Translate white space to tabs

To preserve white space exactly as you type it, set the **Realtabs** switch to `yes` and the **Entab** switch to `0`.

When **Realtabs** is `yes`, the **Tabalign** switch comes into effect. When **Tabalign** is set to `yes`, PWB automatically repositions the cursor onto the physical tab character in the file, similar to the way a word processor positions the cursor. When **Tabalign** is set to `no`, PWB allows the cursor to be anywhere in the tab field.

If you want the **TAB** key to type a tab character, assign the **TAB** key to the **Graphic** function. Note that when a dialog box is displayed, the **TAB** key always moves to the next option. You can always use the following method to type a tab character, whether you are in a dialog box or an editing window.

➔ **To type a literal tab character in your text or in a dialog box:**

1. Execute the **Quote** function (press **CTRL+P**).
2. Press **TAB**.

## Examples

The following example sets up tabs so that they act the same as in other Microsoft editors, such as QuickC or Word:

```
realtabs:yes
tabalign:yes
graphic:tab
trailspace:yes
entab:0
```

The **Trailspace** switch is needed so that the TAB key will have an effect on otherwise blank lines.

To save your file so that it does not include any actual tab characters (ASCII 9), use the following settings:

```
realtabs:no
entab:0
tabstops:3
```

The **Tabstops** value determines the number of spaces inserted for each press of the tab key.

Another example of a common tab configuration is one in which the TAB key inserts a tab in insert mode but moves over text to the next tab stop when the editor is in overtype mode.

First, use the following tab settings:

```
realtabs:yes
tabalign:yes
```

Then insert the following macro into the PWB section of your TOOLS.INI:

```
;Insert mode and overtype mode tabbing
TabIO:= Insertmode +>over Insertmode "\t" => \
      :>over Insertmode Tab
TabIO:TAB
```

For more information on PWB macros see “Writing PWB Macros” on page 98.

## PWB Configuration

PWB keeps track of three kinds of information between sessions in these three files:

<b>File</b>	<b>Information Saved</b>
TOOLS.INI	Configuration and customizations, such as key assignments, colors, and macro definitions
CURRENT.STS	The editing environment used most recently
<i>project.STS</i>	The editing and building environment for a project

TOOLS.INI is described in the next section: “The TOOLS.INI File.” For more information about CURRENT.STS, see “Current Status File CURRENT.STS” on

page 128, and for more information about the *project*.STS files, see “Project Status Files” on page 129.

When you start PWB, it reads the TOOLS.INI file, loads PWB extensions, and reads the CURRENT.STS or project status file in the following order:

1. PWB reads the [PWB] section of TOOLS.INI (except when PWB is started using the /D or /DT command-line options). For more information on tagged sections, see “TOOLS.INI Section Tags.”

If the [PWB] section contains **Load** switches, PWB loads the specified extension when each switch is encountered. When PWB loads an extension, it also reads the extension’s tagged section of TOOLS.INI, if any. For example, when the Help extension is loaded, PWB reads the [PWB-PWBHELP] section of TOOLS.INI.

2. PWB autoloading extensions (except when the /D or /DA option is used to start PWB).

The automatic loading of PWB extensions is described in the next section, “Autoloading Extensions.”

3. PWB reads the TOOLS.INI operating-system tagged section (except when /D or /DT is used).
4. PWB reads the CURRENT.STS status file (except when /D or /DS is used to start PWB).
5. PWB reads the TOOLS.INI tagged section for the file extension of the current file (except when /D or /DT is used to start PWB).
6. PWB runs the **Autostart** macro if it is defined in TOOLS.INI (except when /D or /DT is used).

## Autoloading Extensions

PWB automatically loads extensions if they follow a specific naming convention and reside in a certain directory. For extensions that follow the convention, it is not necessary to put load statements in TOOLS.INI.

PWB searches the directory where the PWB executable file is located for filenames with the following pattern:

```
PWB* .MXT
```

PWB loads as many extensions with names of this form as it finds. When PWB loads an extension, it also loads the extension’s tagged section of TOOLS.INI.

To suppress extension autoloading, use the /DA option on the PWB command line.

---

**Important** Do not rename editor extensions. PWB and some extensions may assume the predefined filename.

---

## The TOOLS.INI File

PWB, like other Microsoft tools, stores information in a file called TOOLS.INI. This file retains information about how you want PWB to work under various circumstances. PWB expects to find this file in the directory specified by your INIT environment variable.

TOOLS.INI is a text file. You can edit it using PWB or any other text editor. PWB also can store information directly to TOOLS.INI when, for example, you choose the Save Colors button in the Colors dialog box. PWB modifies this file when you save a recorded macro, a changed switch, a new key assignment, a custom browser database, or a custom project template.

### TOOLS.INI Section Tags

The TOOLS.INI file is divided into sections, separated by “tags.” These tags are specified in the form:

[[*tagname*]]

The *tagname* is the base name of an executable file, such as NMAKE, CVW, or PWB. The tag defines the start of a TOOLS.INI section that contains settings for the indicated tool.

PWB extends this simple syntax to enable you to take different action depending on the operating system or the current file’s extension. The extended syntax is:

[[**PWB**-*modifier*]]

The modifier can be the base name of a PWB extension, an operating system’s identifier, or a filename extension for files that you edit.

### Operating-System Tags

The following table lists the operating-system tags for various operating environments. If you are running the Windows operating system, use the tag for the version of MS-DOS that you are running.

Tag	Operating Environment
[PWB-4.0]	MS-DOS versions 4.0 and 4.01
[PWB-5.0]	MS-DOS version 5.0

Be sure to use the correct version number for your operating system.

## Filename-Extension Tags

The operating-system tags are read only once at startup. PWB reads the filename-extension tagged sections each time you switch to a file with that extension. For example, suppose that you want the tab stops for MASM files to be every eight columns, and every five columns for text files.

➔ **To set tab options based on filename extension:**

1. Open your TOOLS.INI file in an editing window.
2. Create a MASM section by typing the tag:

```
[PWB-.ASM PWB-.INC ]
```

3. Create a text file section by typing the tag:

```
[PWB-.TXT]
```

4. Put the appropriate **Tabstops**, **Entab**, and **Realtabs** switches in each section. The lines that begin with a semicolon are comments.

```
[PWB-.ASM PWB-.INC
; Set the tab stops for MASM to 8
tabstops : 8
; Translate white space to tabs
entab    : 1
realtabs : no

[PWB-.TXT]
; Set the tab stops for text files to 5
tabstops : 5
; Translate white space to spaces
entab    : 0
realtabs : no
```

Depending on whether the current file is a MASM (.ASM or .INC) file or a text (.TXT) file, the tab stops are set at 8 or 5 columns, respectively.

PWB reads multiple sections and applies the appropriate settings. You can use this to your advantage by storing all your general settings in the [PWB] section and storing differences in separate tagged sections.

Filename-extension tagged sections are useful for the kinds of files you edit most frequently. However, it's impossible to define settings for every conceivable extension. To handle this case, PWB provides a special extension (. .) that means "all extensions not defined elsewhere in TOOLS.INI."

For example, to set tab stops to 5 for all files except MASM files, modify the preceding example to use the [PWB-. .] tag in place of [PWB-.TXT].

**Note**

When you choose the Save button in the Key Assignments, Editor Settings, and Colors dialog boxes, and when you save a recorded macro or custom Run menu command, PWB saves the setting in the main section. If the setting is for a PWB extension, it is saved in that extension's tagged section. PWB never modifies or writes settings in a filename-extension or operating-system section.

---

**Named Tags**

You can define tagged sections of TOOLS.INI that you load manually. Use manually loaded sections to make special key assignments, to load complex or rarely used macros, or to use a special PWB configuration under a particular circumstance.

The syntax for a manually-loaded section tag is:

[PWB-*name*]

Where *name* is the name of the tagged section. A single section of TOOLS.INI can be given several tag names. These tags have the form:

[PWB-*name1* PWB-*name2*...]

When you want to use the settings defined in one of these named sections, pass the name of the section to the **Initialize** function (SHIFT+F8).

**→ To read a tagged section of TOOLS.INI:**

- Execute **Arg name Initialize** (ALT+A *name* SHIFT+F8)

You can use this method to read any tagged section, including the automatically loaded sections.

---

**Note** When you execute Initialize with no arguments, PWB clears all the current settings before reading the [PWB] section, including settings that you have made for specific PWB extensions. PWB does not reread the operating-system or other additional sections of TOOLS.INI. To reread the main section without clearing other settings that you want to remain in effect, label the main PWB section with the tag [PWB PWB-main]. You can then use **Arg main Initialize** to recover your startup settings, instead of using **Initialize** with no arguments.

---

**TOOLS.INI Statement Syntax**

Within each TOOLS.INI section you place a series of comments or statements. Each statement is a macro definition, key assignment, or switch setting, and must be

stated on a single logical line. Statements can be continued across lines by using line-continuations.

## General Macro Syntax

The general syntax for a macro definition is:

*name := definition*

PWB does not reserve any names. Therefore, be careful not to redefine a PWB function. For more information about how to write macros, see “Writing PWB Macros” on page 98.

## General Key Syntax

The general syntax for a key assignment is:

*name : key*

The *name* is the name of a function or macro, and the *key* is the name of a key. To see how to write a given key, use the **Tell** function as described in “Changing Key Assignments” on page 109.

Note that certain keys have fixed meanings when the cursor is in a dialog box or in the Help window. You can assign one of these keys to a function or macro, but the fixed meaning is used in a dialog box or the Help window.

The following keys have fixed meanings:

Key	Dialog Box	Help Window
ESC	Choose Cancel	Close the Help window
F1	See Help on the dialog box (choose Help)	See Help on the current item
TAB	Move to the next option	Move to the next hyperlink
SHIFT+TAB	Move to the previous option	Move to the previous hyperlink
SPACEBAR	Toggle the setting of the current option	Activate the current hyperlink
ENTER, SHIFT+ENTER, NUMENTER, SHIFT+NUMENTER	Choose the default action	Activate the current hyperlink

---

**Note** The Windows operating system or a terminate-and-stay-resident (TSR) program may override PWB's use of specific keys. PWB has no knowledge of keys that are reserved by these external processes. PWB lists these keys as available keys in the Key Assignments dialog box and allows you to assign functions to these keys, but you may not be able to use them. See the documentation for your operating environment to see what keys are reserved by the system.

---

## General Switch Syntax

The general syntax for a switch setting is:

*switch* : *value*

The exact syntax for the switch value depends on the switch. See Chapter 7, "PWB Reference," for more information about each switch.

## Line Continuation

All statements in TOOLS.INI must be stated on a single logical line. A logical line can be written on several physical lines by using the TOOLS.INI line-continuation character, the backslash (\).

The backslash must be preceded by a space to be treated as a line-continuation character. Precede the backslash by two spaces if you want the concatenated statement to contain a space at that location. If the backslash is preceded by a tab, PWB treats the tab as if it were two spaces. The backslash should be the last character on the line except for spaces or tabs.

The backslash in the following statement is *not* a line continuation.

```
Qreplace:CTRL+\
```

However, the backslash at the end of the first line below *is* a line continuation.

```
findtag:=Arg Arg "^\[^\]+\\]" Psearch ->nf \
  Arg Setwindow => :>nf Arg "no tag" Message
```

In this example, the backslash is preceded by two spaces. The first space is included to separate `->nf` from `Arg` in the concatenated macro definition. The second space identifies the backslash that follows it as the line-continuation character.

## Comments

In the TOOLS.INI file, PWB treats the text that follows a semicolon (;) up to the end of the line as a comment. To specify the beginning of a comment, you must place the semicolon at the beginning of a line or following white space.

For example, the first semicolon in the following statement is part of a command, and the second semicolon begins a comment.



```
Printcmd:lister -t4 %s -c; ;Print using lister program
```

In the following example, the first semicolon is a key name, and the second semicolon begins a comment.

```
Sinsert:CTRL+; ;Stream insertion: CTRL plus semicolon
```

Semicolons inside a quoted string do not begin a comment.

## Environment Variables

The INIT environment variable tells PWB where to find the TOOLS.INI file and where to store the CURRENT.STS file. In general, the INIT, TMP, LIB, INCLUDE, HELPFILES, and PATH environment variables must all be properly set for your development environment to work smoothly.

### → To set the INIT environment variable from the command line:

◆ Type `SET INIT=C:\INIT`

The operating-system **SET** command sets the environment variable to contain the string `C:\INIT`. This example presumes that you want to store your initialization files in `C:\INIT`. You could use any other directory. Make sure that the INIT environment variable lists a single directory. Multiple directories in INIT can cause inconsistent behavior.

The following list outlines how the environment works:

- ◆ The environment is always inherited from the parent process. The parent is the process that starts the current process. In MS-DOS, the parent is often `COMMAND.COM` or the Windows operating system.
- ◆ Inheritance of environment variables is a one-way process. A child inherits from its parent. You can make changes to the environment in a child (when you use the Environment Variables command in PWB, for example), but they are not passed back to the parent. This means that any changes to environment variables that you make while shelled out are lost when you return to PWB.
- ◆ Each MS-DOS session under the Windows operating system inherits its environment from the Windows operating system. Changes made to the environment in one session do not affect any other session.

The best way to make sure your environment is set properly is to explicitly set it in one of your startup files. These are:

- ◆ `CONFIG.SYS`
- ◆ `AUTOEXEC.BAT`

PWB can save the complete table of environment variables for each project. You can then use the Environment Variables command from the Options menu to change environment variables for individual projects.

If you prefer that PWB save the environment variables for all PWB sessions or use the current operating-system environment when it starts up, change the **Envcursave** and **Envprojsave** switches. For more information on these switches, see the “Programmer’s WorkBench Reference” on pages 259 and 260.

## Current Status File CURRENT.STS

The first time you run PWB or CodeView, it creates a CURRENT.STS (current status) file in your INIT directory. If there is no INIT directory, PWB and CodeView create the file in the current directory.

CURRENT.STS keeps track of the following items for PWB:

- ◆ Open windows, including their size and position and the list of open files in each window
- ◆ Screen height
- ◆ Window style
- ◆ Find string
- ◆ Replace string
- ◆ The options used in a find or find-and-replace operation, such as the use of regular expressions
- ◆ Optionally, all environment variables

PWB and CodeView share the current location and filename for the active window. When you leave CodeView after a debugging session and return to PWB, PWB positions the cursor at the place where you stopped debugging. For more information on the items that CodeView saves in CURRENT.STS, see “The CURRENT.STS State File” on page 316.

The next time you run PWB, it reads CURRENT.STS and restores the editing environment to what it was when you left PWB. For more information on how PWB uses environment variables, see “Environment Variables” on page 127.

The status files are plain text files. You can load one into an editor and read it. However, you might corrupt the file if you try to modify it. There is no need to modify it because PWB keeps it updated for you. No harm occurs if you delete CURRENT.STS. However, you will have to manually reopen the files you were working on.

## Project Status Files

For each project, PWB creates a project status file. PWB stores this file in the project directory and gives it the name *project.STS*, where *project* is the base name of the project.

Project status files contain the same kind of information that *CURRENT.STS* contains, except on a per-project basis. This scheme allows PWB to keep track of your screen layout, file history, and environment variables for each project. The project status files also contain the current project template, language and utility options, build directory, and the program's run-time arguments.

The main difference between the two status files is that the *CURRENT.STS* file supplies default status information—settings that PWB uses when you have not set a project. PWB uses the project's status file when you open that project.

PWB can also save all environment variables, including *PATH*, *INCLUDE*, *LIB*, and *HELPPFILES*, depending on how the **envcursave** and **envprojsave** switches are set. For more information, see “Environment Variables” on page 127.

---

**Important** While it is harmless to delete *CURRENT.STS*, you should *not* delete project status files. They contain important information for building and updating your project. If you delete a project status file, you may need to delete the project makefile and start over.

---



## CHAPTER 7

# Programmer's WorkBench Reference

## PWB Command Line

**Syntax** PWB *[[options]] [[/t]] files*

**Options** Use the following case-insensitive options when starting PWB:

**/D***[[S|T|A]]...*

Disables PWB loading the initialization files or PWB extensions as indicated by the following letters:

Letter	Meaning
S	Disable reading the status file CURRENT.STS
T	Disable reading TOOLS.INI
A	Disable PWB extension autoload

The /D option alone disables loading all the PWB extension and initialization files. See: **Autoload**.

---

**Note** If you start PWB with the /DT option, this means that PWB options you change during the session cannot be saved.

---

**/PP** *makefile*

Opens the specified PWB project.

**/PF** *makefile*

Opens the specified non-PWB project (foreign makefile).

**/PL**

Resets the last project. Use this option to start PWB in the same state you last left it. You can set this option as the default by setting the **Lastproject** switch to yes.

**/E** *command*

Executes the given command or sequence of commands as a macro upon startup.

If *command* contains a space, *command* should be enclosed in double quotation marks (""). A single command need not be quoted. If *command* uses literal quotation marks, place a backslash (\) before each mark. To use a backslash, precede it with another backslash.

**/R**

PWB starts in no-edit mode. You cannot modify files in this mode. See: **Noedit**.

**/M** {*mark* | *line*}

PWB starts at the specified location. See: **Mark**.

[[**/T**] *file*]...

Tells PWB to load the given files on startup. If you specify a single file, PWB loads it. If you specify multiple files, PWB loads the first file; then when you use File Next or the **Exit** function, PWB loads the next file in the list.

If a **/T** precedes a filename or wildcard, PWB loads each file as a temporary file. PWB does not include temporary files in the list of files saved between sessions.

---

**Note** No other options can follow **/T** on the PWB command line. You must specify **/T** for each file you want to be temporary.

---

## PWB Menus and Keys

Many PWB menu commands activate PWB functions or predefined macros. The menu commands that are attached to functions and macros are listed in the tables that follow. To assign a shortcut key for one of these menu commands, use the Key Assignments command on the Options menu and assign a key to the corresponding function or macro. For details on using the Key Assignments dialog box, see “Changing Key Assignments” on page 109.

Names beginning with an underscore (\_pwb...) are macros. Names without an underscore are functions.

**Table 7.1 File Menu and Keys**

Menu Command	Macro or Function	Default Keys
New	_pwbnewfile	Unassigned
Close	_pwbclosefile	Unassigned
Next	_pwbnextfile	Unassigned
Save	_pwbsavefile	SHIFT+F2
Save All	_pwbsaveall	Unassigned

**Table 7.1 File Menu and Keys** (*continued*)

Menu Command	Macro or Function	Default Keys
DOS Shell	_pwbshell	Unassigned
<i>n file</i>	_pwbfilen	Unassigned
Exit	_pwbquit	ALT+F4

**Table 7.2 Edit Menu and Keys**

Menu Command	Macro or Function	Default Keys
Undo	_pwbundo	Unassigned
Redo	_pwbredo	Unassigned
Repeat	_pwbrepeat	Unassigned
Cut	Delete	SHIFT+DEL, SHIFT+NUM-
Copy	Copy	CTRL+INS, SHIFT+NUM*
Paste	Paste	SHIFT+INS, SHIFT+NUM+
Delete	_pwbclear	DEL
Set Anchor	Savecur	Unassigned
Select To Anchor	Selcur	Unassigned
Stream Mode	_pwbstreammode	Unassigned
Box Mode	_pwbboxmode	Unassigned
Line Mode	_pwblinemode	Unassigned
Record On	_pwbrecord	Unassigned

**Table 7.3 Search Menu and Keys**

Menu Command	Macro or Function	Default Keys
Log	_pwblogsearch	Unassigned
Next Match (Logging on)	_pwbnextlogmatch	SHIFT+CTRL+F3
Next Match (Logging off)	_pwbnextmatch	Unassigned
Previous Match (Logging on)	_pwbpreviouslogmatch	SHIFT+CTRL+F4
Previous Match (Logging off)	_pwbpreviousmatch	Unassigned
Goto Match	_pwbgotomatch	Unassigned

**Table 7.4 Project Menu and Keys**

<b>Menu Command</b>	<b>Macro or Function</b>	<b>Default Keys</b>
Compile File	_pwbcompile	Unassigned
Build	_pwbbuild	Unassigned
Rebuild All	_pwbrebuild	Unassigned
Close	_pwbcloseproject	Unassigned
Next Error	_pwbnextmsg	SHIFT+F3
Previous Error	_pwbprevmsg	SHIFT+F4
Goto Error	_pwbsetmsg	Unassigned

**Table 7.5 Run Menu and Keys**

<b>Menu Command</b>	<b>Macro or Function</b>	<b>Default Keys</b>
<i>command1</i>	_pwbuser1	[ALT+Fn]
<i>command2</i>	_pwbuser2	[ALT+Fn]
<i>command3</i>	_pwbuser3	[ALT+Fn]
<i>command4</i>	_pwbuser4	[ALT+Fn]
<i>command5</i>	_pwbuser5	[ALT+Fn]
<i>command6</i>	_pwbuser6	[ALT+Fn]
<i>command7</i>	_pwbuser7	[ALT+Fn]
<i>command8</i>	_pwbuser8	[ALT+Fn]
<i>command9</i>	_pwbuser9	[ALT+Fn]

**Table 7.6 Browse Menu and Keys**

<b>Menu Command</b>	<b>Macro or Function</b>	<b>Default Keys</b>
Goto Definition	Pwbrowsegotodef	Unassigned
Goto Reference	Pwbrowsegotoref	Unassigned
View Relationship	Pwbrowseviewrel	Unassigned
List References	Pwbrowselistref	Unassigned
Call Tree (Fwd/Rev)	Pwbrowsecalltree	Unassigned
Function Hierarchy	Pwbrowsefuhier	Unassigned
Module Outline	Pwbrowseoutline	Unassigned
Which Reference	Pwbrowsewhref	Unassigned
Class Tree (Fwd/Rev)	Pwbrowsecltree	Unassigned
Class Hierarchy	Pwbrowseclhier	Unassigned



**Table 7.6 Browse Menu and Keys** (*continued*)

Menu Command	Macro or Function	Default Keys
Next	Pwbrowse <code>next</code>	CTRL+NUM+
Previous	Pwbrowse <code>prev</code>	CTRL+NUM-

**Table 7.7 Window Menu and Keys**

Menu Command	Macro or Function	Default Keys
New	<code>_pwbnewwindow</code>	Unassigned
Close	<code>_pwbclose</code>	CTRL+F4
Close All	<code>_pwbcloseall</code>	Unassigned
Move	<code>_pwbmove</code>	CTRL+F7
Size	<code>_pwbresize</code>	CTRL+F8
Restore	<code>_pwbrestore</code>	CTRL+F5
Minimize	<code>_pwbminimize</code>	CTRL+F9
Maximize	<code>_pwbmaximize</code>	CTRL+F10
Cascade	<code>_pwbcascade</code>	F5
Tile	<code>_pwbtile</code>	SHIFT+F5
Arrange	<code>_pwbarrange</code>	ALT+F5
<i>n file</i>	<code>_pwbwindown</code>	ALT+n

**Table 7.8 Help Menu and Keys**

Menu Command	Macro or Function	Default Keys
Index	<code>_pwbhelp_index</code>	Unassigned
Contents	<code>_pwbhelp_contents</code>	SHIFT+F1
Topic	<code>_pwbhelp_context</code>	F1
Help on Help	<code>_pwbhelp_general</code>	Unassigned
Next	<code>_pwbhelp_again</code>	Unassigned
Search Results	<code>_pwbhelp_searchres</code>	Unassigned

## PWB Default Key Assignments

PWB's default keys assignments are shown in table 7.9. In each position having the text `Unassigned`, you can assign a function or macro to that key without taking away a default keystroke. You cannot assign keys for positions that are empty.

These can usually be expressed in a different way. For example, CTRL+{ is expressed as SHIFT+CTRL+[.

**Table 7.9 PWB Default Key Assignments**

Key	Plain	SHIFT	ALT	CTRL	CTRL+SHIFT
!	—	—	—	—	—
#	Graphic	—	—	—	—
\$	Graphic	—	—	—	—
%	Graphic	—	—	—	—
&	Graphic	—	—	—	—
(	Graphic	—	—	—	—
*	Graphic	—	—	—	—
+	Graphic	—	—	—	—
,	Graphic	—	Unassigned	—	—
-	Graphic	—	Unassigned	Unassigned	—
.	Graphic	—	Unassigned	Unassigned	—
/	Graphic	—	Unassigned	Unassigned	—
0	Graphic	—	Unassigned	Unassigned	—
1	Graphic	—	_pwbwindow1	Unassigned	—
2	Graphic	—	_pwbwindow2	Unassigned	—
3	Graphic	—	_pwbwindow3	Unassigned	—
4	Graphic	—	_pwbwindow4	Unassigned	—
5	Graphic	—	_pwbwindow5	Unassigned	—
6	Graphic	—	_pwbwindow6	Unassigned	—
7	Graphic	—	_pwbwindow7	Unassigned	—
8	Graphic	—	_pwbwindow8	Unassigned	—
9	Graphic	—	_pwbwindow9	Unassigned	—
:	Graphic	—	Unassigned	—	Unassigned
;	Graphic	—	Unassigned	Unassigned	—
<	Graphic	—	Unassigned	—	Unassigned
=	Graphic	—	Assign	Unassigned	—
>	Graphic	—	Unassigned	—	Unassigned
@	Graphic	—	—	—	Unassigned
A	Graphic	Graphic	Arg	Mword	Unassigned
B	Graphic	Graphic	(Browse menu)	Unassigned	Unassigned
C	Graphic	Graphic	Unassigned	Ppage	Unassigned
D	Graphic	Graphic	Unassigned	Right	Unassigned

**Table 7.9** PWB Default Key Assignments (*continued*)

Key	Plain	SHIFT	ALT	CTRL	CTRL+SHIFT
E	Graphic	Graphic	(Edit menu)	Up	Unassigned
F	Graphic	Graphic	(File menu)	Pword	Unassigned
G	Graphic	Graphic	Unassigned	Cdelete	Unassigned
H	Graphic	Graphic	(Help menu)	Unassigned	Unassigned
I	Graphic	Graphic	Unassigned	Unassigned	Unassigned
J	Graphic	Graphic	Unassigned	Sinsert	Unassigned
K	Graphic	Graphic	Unassigned	Unassigned	Unassigned
L	Graphic	Graphic	Unassigned	Replace	Unassigned
M	Graphic	Graphic	Unassigned	Mark	Unassigned
N	Graphic	Graphic	Unassigned	Linsert	Unassigned
O	Graphic	Graphic	(Options menu)	Lasttext	Unassigned
P	Graphic	Graphic	(Project menu)	Quote	Unassigned
Q	Graphic	Graphic	Unassigned	Unassigned	Unassigned
R	Graphic	Graphic	(Run menu)	Mpage	Record
S	Graphic	Graphic	(Search menu)	Left	Sethelp
T	Graphic	Graphic	Unassigned	Tell	Unassigned
U	Graphic	Graphic	Unassigned	Lastselect	Unassigned
V	Graphic	Graphic	Unassigned	Insertmode	Unassigned
W	Graphic	Graphic	(Window menu)	Mlines	Unassigned
X	Graphic	Graphic	Unassigned	Down	Unassigned
Y	Graphic	Graphic	Unassigned	Ldelete	Unassigned
Z	Graphic	Graphic	Unassigned	Plines	Unassigned
[	Graphic	—	Unassigned	Pbal	Unassigned
\	Graphic	—	Unassigned	Qreplace	Unassigned
]	Graphic	—	Unassigned	Setwindow	Unassigned
^	Graphic	—	—	—	Unassigned
_	Graphic	—	—	—	Unassigned
{	Graphic	—	Unassigned	—	—
	Graphic	—	Unassigned	—	—
}	Graphic	—	Unassigned	—	—
~	Graphic	—	Unassigned	—	Unassigned
F1	_pwbhelp- _context	_pwbhelp- _contents	_pwbhelp_back	Pwbhelpnext	Unassigned
F2	Setfile	_pwbsavefile	Unassigned	Unassigned	Unassigned

**Table 7.9 PWB Default Key Assignments** (*continued*)

Key	Plain	SHIFT	ALT	CTRL	CTRL+SHIFT
F3	Psearch	_pwbnextmsg	Unassigned	Compile	_pwbnext-logmatch
F4	Msearch	_pwbprevmsg	_pwbquit	_pwbclose	_pwbprevious-logmatch
F5	_pwbcascade	_pwbtile	_pwbarrange	_pwbrestore	Unassigned
F6	Selwindow	_pwb-prevwindow	Unassigned	Winstyle	Unassigned
F7	Execute	Refresh	Unassigned	_pwbmove	Unassigned
F8	Exit	Initialize	Unassigned	_pwbresize	Unassigned
F9	Meta	Shell	Unassigned	_pwbminimize	Unassigned
F10	Openfile	Unassigned	Unassigned	_pwbmaximize	Unassigned
F11	Unassigned	Unassigned	Unassigned	Unassigned	Unassigned
F12	Unassigned	Unassigned	Unassigned	Unassigned	Unassigned
F13	Unassigned	Unassigned	Unassigned	Unassigned	Unassigned
F14	Unassigned	Unassigned	Unassigned	Unassigned	Unassigned
F15	Unassigned	Unassigned	Unassigned	Unassigned	Unassigned
F16	Unassigned	Unassigned	Unassigned	Unassigned	Unassigned
LEFT	Left	Select	Unassigned	Mword	Select
RIGHT	Right	Select	Unassigned	Pword	Select
UP	Up	Select	Unassigned	Mlines	Unassigned
DOWN	Down	Select	Unassigned	Plines	Unassigned
INS	Insertmode	Paste	Unassigned	Copy	Unassigned
DEL	_pwbclear	Delete	Unassigned	Unassigned	Unassigned
HOME	Begline	Select	Unassigned	Begfile	Select
END	Endline	Select	Unassigned	Endfile	Select
ENTER	Emacsnewl	Newline	Unassigned	Unassigned	Unassigned
BKSP	Emacscdel	Emacscdel	Undo	Unassigned	Undo
ESC	Cancel	Unassigned	Unassigned	Unassigned	Unassigned
GOTO	Home	Unassigned	Unassigned	Unassigned	Unassigned
NUM*	Graphic	Copy	Unassigned	Unassigned	Unassigned
NUM+	Graphic	Paste	Unassigned	Pwbrowsenext	Unassigned
NUM-	Graphic	Delete	Unassigned	Pwbrowseprev	Unassigned
NUM/	Graphic	—	Unassigned	Unassigned	Unassigned
NUM-ENTER	Emacsnewl	Newline	Unassigned	Unassigned	Unassigned

**Table 7.9 PWB Default Key Assignments** (*continued*)

Key	Plain	SHIFT	ALT	CTRL	CTRL+SHIFT
PGUP	Mpage	Select	Unassigned	Unassigned	Select
PGDN	Ppage	Select	Unassigned	Unassigned	Select
TAB	Tab	Backtab	Unassigned	Unassigned	Unassigned

## Note on Available Keys

PWB allows you to assign functions and macros to almost any key combination. However, some keys have a fixed meaning in certain circumstances or operating environments. PWB lists these key as available keys in the Key Assignments dialog box, and PWB allows you to assign a command to the key. However, when the circumstance holds, or you are running PWB in a specific environment, certain keys have a fixed meaning that overrides any assignment that you make.

### Help Window

In the Help window, the following keys have a fixed meaning:

Key	Meaning
ESC	Close the Help window
TAB	Move to next hyperlink
SHIFT+TAB	Move to previous hyperlink
ENTER	Activate current hyperlink
NUMENTER	Activate current hyperlink
SHIFT+ENTER	Activate current hyperlink
SHIFT+NUMENTER	Activate current hyperlink
SPACE	Activate current hyperlink

### Dialog Boxes

In dialog boxes, all keys have predetermined meanings. Your assignments have no effect when a dialog box is displayed. In particular, note the following keys:

Key	Meaning
ESC	Choose Cancel
ENTER	Choose the active command button
F1	Choose Help
TAB	Move to the next option or command
SHIFT+TAB	Move to the previous option or command

Key	Meaning
SPACE	Toggle active option
CTRL+P	When used in a text box, inserts the next key as a literal value. Use this key to type a literal tab character.

The Text Argument dialog box is an exception. All keys except ESC (Cancel) and F1 (Help) have their assigned meaning.

### Microsoft Windows

When running PWB with the Windows operating system, some keys are reserved for use by Windows. You can override these reserved keys by setting options in a PIF file.

Key	Default Meaning in the Windows operating system
ALT+ESC	Switch to the next window in the Windows operating system
CTRL+ESC	Switch to the the Windows operating system Task Manager
ALT+TAB	Switch to the next application
ALT+SPACE	Activate the current window's system menu
ALT+ENTER	Shift application between full screen and window

## PWB Functions

PWB provides a rich variety of editing, searching, and project-management capabilities in the form of functions. Most of PWB's menus and dialogs call these functions (or macros that use these functions) to perform their actions. You can write your own macros that use these capabilities in ways that precisely suit your needs. You can also execute every function directly, either by pressing a key or by using the **Execute** function.

Table 7.10 summarizes PWB functions. Most functions can be executed in different ways to perform related actions. Complete details are given in the A-to-Z reference that follows the table.

**Table 7.10 PWB Functions**

Function	Description	Keys
Arg	Begin a function argument	ALT+A
Arrangewindow	Arrange windows or icons	Unassigned
Assign	Define a macro or assign a key	ALT+=
Backtab	Move to previous tab stop	SHIFT+TAB
Begfile	Move to beginning of file	CTRL+HOME
Begline	Move to beginning of line	HOME

**Table 7.10 PWB Functions** (*continued*)

<b>Function</b>	<b>Description</b>	<b>Keys</b>
Cancel	Cancel arguments or current operation	ESC
Cancelsearch	Cancel background search	Unassigned
Cdelete	Delete character	CTRL+G
Clearmsg	Clear Build Results	Unassigned
Clearsearch	Clear Search Results	Unassigned
Closefile	Close current file	Unassigned
Compile	Compile and build	CTRL+F3
Copy	Copy selection to the clipboard	CTRL+INS, SHIFT+NUM*
Curdate	Today's date ( <i>dd-Mmm-yyyy</i> )	Unassigned
Curday	Day of week ( <i>Tue</i> )	Unassigned
Curtime	Current time ( <i>hour:minute:second</i> )	Unassigned
Delete	Delete selection	SHIFT+DEL, SHIFT+NUM-
Down	Move down one line	CTRL+X, DOWN
Emacscdel	Delete character	BKSP, SHIFT+BKSP
Emacsnewl	Start a new line	ENTER, NUMENTER
Endfile	Move to end of file	CTRL+END
Endline	Move to end of line	END
Environment	Set or insert environment variable	Unassigned
Execute	Execute macros and functions by name	F7
Exit	Advance to next file or leave PWB	F8
Graphic	Type character	(many)
Home	Move to window corner	GOTO
Information	(Obsolete)	—
Initialize	Reinitialize	SHIFT+F8
Insert	Insert spaces or lines	Unassigned
Insertmode	Toggle insert/overwrite mode	CTRL+V, INS
Lastselect	Recover last selection	CTRL+U
Lasttext	Recover last text argument	CTRL+O
Ldelete	Delete lines	CTRL+Y
Left	Move left	CTRL+S, LEFT
Linsert	Insert lines or indent line	CTRL+N
Logsearch	Toggle search logging	Unassigned

**Table 7.10 PWB Functions** *(continued)*

<b>Function</b>	<b>Description</b>	<b>Keys</b>
Mark	Set, clear, or go to a mark or line number	CTRL+M
Maximize	Enlarge window to full size	Unassigned
Menukey	Activate menu	ALT
Message	Display a message or refresh the screen	Unassigned
Meta	Modify the action of a function	F9
Mgrep	Search across files for text or pattern	Unassigned
Minimize	Shrink window to an icon	Unassigned
Mlines	Scroll down by lines	CTRL+UP, CTRL+W
Movewindow	Move window	Unassigned
Mpage	Move up one page	CTRL+R, PGUP
Mpara	Move up one paragraph	Unassigned
Mreplace	Multifile replace with confirmation	Unassigned
Mreplaceall	Multifile replace	Unassigned
Msearch	Search backward for pattern or text	F4
Mword	Move back one word	CTRL+A, CTRL+LEFT
Newfile	Create a new pseudofile	Unassigned
Newline	Move to the next line	SHIFT+ENTER, SHIFT+NUMENTER
Nextmsg	Go to build message location	Unassigned
Nextsearch	Go to search match location	Unassigned
Noedit	Toggle the no-edit restriction	Unassigned
Openfile	Open a new file	F10
Paste	Insert file or text from clipboard	SHIFT+INS, SHIFT+NUM+
Pbal	Balance paired characters	CTRL+[
Plines	Scroll up by lines	CTRL+DOWN, CTRL+Z
Ppage	Move down one page	CTRL+C, PGDN
Ppara	Move down one paragraph	Unassigned
Print	Print file or selection	Unassigned
Project	Set or clear project	Unassigned
Prompt	Request text argument	Unassigned
Psearch	Search forward for pattern or text	F3
Pwbhelp	Help topic lookup	Unassigned



**Table 7.10 PWB Functions** (*continued*)

<b>Function</b>	<b>Description</b>	<b>Keys</b>
Pwbhelpnext	Relative help topic lookup	CTRL+F1
Pwbhelpsearch	Global full-text help search	Unassigned
Pwbrowse1stdef	Go to first definition	Unassigned
Pwbrowse1stref	Go to first reference	Unassigned
Pwbrowsecalltree	Browse Call Tree (Fwd/Rev)	Unassigned
Pwbrowseclhier	Browse Class Hierarchy	Unassigned
Pwbrowsecltree	Browse Class Tree (Fwd/Rev)	Unassigned
Pwbrowsefuhier	Browse Function Hierarchy	Unassigned
Pwbrowsegotodef	Browse Goto Definition	Unassigned
Pwbrowsegotoref	Browse Goto Reference	Unassigned
Pwbrowselistref	Browse List References	Unassigned
Pwbrowsenext	Browse Next	CTRL+NUM+
Pwbrowseoutline	Browse Module Outline	Unassigned
Pwbrowsepop	Go to previously browsed location	Unassigned
Pwbrowseprev	Browse Previous	CTRL+NUM-
Pwbrowseviewrel	Browse View Relationship	Unassigned
Pwbrowsewhref	Browse Which Reference?	Unassigned
Pwbwindow	Open a PWB window	Unassigned
Pword	Move forward one word	CTRL+F, CTRL+RIGHT
Qreplace	Replace with confirmation	CTRL+\
Quote	Insert literal key	CTRL+P
Record	Toggle macro recording	SHIFT+CTRL+R
Refresh	Reread or discard file	SHIFT+F7
Repeat	Repeat the last editing operation	Unassigned
Replace	Replace pattern or text	CTRL+L
Resize	Resize window	Unassigned
Restcur	Restore saved position	Unassigned
Right	Move right	CTRL+D, RIGHT
Saveall	Save all modified files	Unassigned
Savecur	Save cursor position	Unassigned
Sdelete	Delete streams	Unassigned
Searchall	Highlight occurrences of pattern or text	Unassigned
Selcur	Select to saved position	Unassigned

**Table 7.10 PWB Functions** *(continued)*

Function	Description	Keys
Select	Select text	SHIFT+PGUP, SHIFT+CTRL+PGUP, SHIFT+PGDN, SHIFT+CTRL+PGDN, SHIFT+END, SHIFT+CTRL+END, SHIFT+HOME, SHIFT+CTRL+HOME, SHIFT+LEFT, SHIFT+CTRL+LEFT, SHIFT+UP, SHIFT+RIGHT, SHIFT+CTRL+RIGHT, SHIFT+DOWN
Selmode	Change selection mode: box	Unassigned
Selwindow	Move to window	F6
Setfile	Open or change files	F2
Sethelp	Opens, closes, and lists help files	SHIFT+CTRL+S
Setwindow	Adjust file in window	CTRL+] ]
Shell	Start a shell or run a system command	SHIFT+F9
Sinsert	Insert a stream of blanks or break line	CTRL+J
Tab	Move to the next tab stop	TAB
Tell	Show key assignment or macro definition	CTRL+T
Unassigned	Remove a function assignment from a key	(All unassigned keys)
Undo	Undo and redo editing operations	ALT+BKSP, SHIFT+CTRL+BKSP
Up	Move up	CTRL+E, UP
Usercmd	Execute a custom Run menu command	Unassigned
Window	Move to next or previous window	Unassigned
Winstyle	Add or remove scroll bars	CTRL+F6

## Cursor-Movement Commands

PWB provides the following commands to navigate through text. In addition to the commands in the PWB editor, the Source Browser provides powerful commands to navigate through the source of your programs.

**Table 7.11 Cursor-Movement Commands**

Cursor Movement	Command	Keys
Up one line	Up	UP
Down one line	Down	DOWN
Left one column	Left	LEFT
Right one column	Right	RIGHT
Upper-left corner of window	Home	HOME
Top of window	Meta Up	F9 UP
Bottom of window	Meta Down	F9 DOWN
Leftmost column in window	Meta Left	F9 LEFT
Rightmost column in window	Meta Right	F9 RIGHT
Lower-right corner of window	Meta Home	HOME
Up one window	Mpage	PGUP
Down one window	Ppage	PGDN
Column one	Meta Begline	F9 HOME
One column past window width	Meta Endline	F9 END
Back one word	Mword	CTRL+LEFT
Forward one word	Pword	CTRL+RIGHT
Beginning of line	Begline	HOME
End of line	Endline	END
Next paragraph	Ppara	Unassigned
Previous paragraph	Mpara	Unassigned
End of paragraph	Meta Ppara	F9 Unassigned
End of previous paragraph	Meta Mpara	F9 Unassigned
Beginning of file	Begfile	CTRL+HOME
End of file	Endfile	CTRL+END
To specific line number	Arg <i>number</i> Mark	ALT+A <i>number</i> CTRL+M
Position before last scroll	Arg Mark	ALT+A CTRL+M
Saved position	Restcur	Unassigned
Named mark	Arg <i>name</i> Mark	ALT+A <i>name</i> CTRL+M
Scroll window down one line	Mlines	CTRL+UP
Scroll window up one line	Plines	CTRL+DOWN
Scroll window so cursor at top	Arg Plines	ALT+A CTRL+DOWN

**Table 7.11** Cursor-Movement Commands (*continued*)

Cursor Movement	Command	Keys
Scroll window so cursor at bottom	Arg Mlines	ALT+A CTRL+UP
Scroll window so cursor at home	Arg Setwindow	ALT+A CTRL+] ]

## Arg

### Key

ALT+A

### Arg

Begin an argument to a function or begin a selection.

After you execute **Arg**, PWB displays `Arg [1]` on the status bar. Each time you execute **Arg**, PWB increments the Arg count.

PWB functions perform variations of their action depending on the Arg count and the “Meta state.” You can use the **Meta** and **Arg** function prefixes in any order. See: **Meta**.

#### ➔ To select text or create a function argument:

1. Execute **Arg** (ALT+A).
2. Execute a cursor-movement function.

Or hold down the SHIFT key and click the left mouse button.

PWB creates a stream, box, or line selection based on the current selection mode. A selection in each of these modes creates a function argument called “streamarg,” “boxarg,” or “linearg,” respectively.

#### ➔ To create a text argument:

1. Execute **Arg** (ALT+A).
2. Type the text of the argument.

When you type the first character of the argument, PWB displays the Text Argument dialog box where you can enter the textarg without modifying your file. The Text Argument dialog box does not have an OK button; instead, you execute the function to which you are passing the text argument. Choose Cancel to save the text and do nothing.

- ➔ **To “pick up” text from a window:**
  1. Select the text that you want to use in the Text Argument dialog box.
  2. Execute **Lasttext** (CTRL+O).  
PWB copies the selected text into the text argument dialog box.
  
- ➔ **To cancel an argument or selection:**
  - ◆ Execute **Cancel** (ESC).

**Returns** The return value of **Arg** cannot be tested.

**See** **Cancel, Lastselect, Lasttext, Meta, Prompt**

## Arrangewindow

**Key** Unassigned

### **Arrangewindow**

Cascades all unminimized windows on the desktop. Does not affect minimized windows. See: **\_pwbcascade**.

### **Arg Arrangewindow** (ALT+A Unassigned)

Arranges all unminimized windows on the desktop. Does not affect minimized windows. See: **\_pwbarrange**.

### **Meta Arrangewindow** (F9 Unassigned)

Tiles up to 16 unminimized windows. Does not affect minimized windows. See: **\_pwbtile**.

### **Meta Arg Arrangewindow** (F9 ALT+A Unassigned)

Arranges all icons (minimized windows) on the desktop.

**Returns** True Windows or icons arranged.  
False Nothing to arrange, or more than 16 windows open.

## Assign

**Key** ALT+=

The **Assign** function assigns a function to a keystroke, defines a macro, or sets a PWB switch. You can also assign keys and set switches by using the commands in

the Options menu. To see the current assignment for a key or the definition of a macro, use Options Keys Assignments or the **Tell** function (CTRL+T). See: **Tell**.

### Assign

Performs the assignment using the text on the current line. If the line ends with a line continuation, PWB uses the next line, and so on for all continued lines.

### Arg Assign (ALT+A ALT+=)

Same as **Assign**, except uses text starting from the cursor.

### Arg *textarg* Assign (ALT+A *textarg* ALT+=)

Performs the assignment using the specified *textarg*.

### Arg *mark* Assign (ALT+A *mark* ALT+=)

Performs the assignment using the text from the line at the cursor to the specified mark. The *mark* argument can be either a line number or a previously defined mark name. See: **Mark**.

### Arg *boxarg* | *linearg* | *streamarg* Assign (ALT+A *boxarg* | *linearg* | *streamarg* ALT+=)

Performs the assignment using the selected text. Ignores blank and comment lines.

### Returns

True      Assignment successful.  
False     Assignment invalid.

### Example

#### ➔ To set the Tabstops switch to 8:

1. Execute **Arg** (ALT+A).
2. Type the following switch assignment:

```
tabstops:8
```

3. Execute **Assign** (ALT+=).

### Update

#### Assign

#### Arg Assign

With PWB 1.x, **Assign** and **Arg Assign** do not recognize line continuations. With PWB 2.00, they use all continued lines for the assignment.

#### Arg *streamarg* Assign

With PWB 1.x, a *streamarg* is not allowed. With PWB 2.00, **Assign** accepts a *streamarg*.

#### Arg ? Assign

With PWB 1.x, this form of the **Assign** function displays the current assignments for all functions, switches, and macros in the “<ASSIGN>Current Assignments and Switch Settings” pseudofile.

With PWB 2.00, the <ASSIGN> pseudofile does not exist; therefore, this form of the **Assign** function is obsolete. If you use this command or execute a macro that executes this command, PWB issues the error:

```
Missing ':' in '?'
```

PWB is expecting an assignment or definition using the name ?, which is a legal macro name.

---

## Backtab

**Key**                   SHIFT+TAB

### **Backtab**

Moves the cursor to the previous tab stop on the line.

**Returns**               True       Cursor moved.  
                          False       Cursor is at left margin.

**Update**               PWB 2.0 supports variable tab stops. PWB 1.x supports only fixed-width tab stops.

**See**                   **Tab, Tabstops**

---

## Begfile

**Key**                   CTRL+HOME

### **Begfile**

Moves the cursor to the beginning of the file.

**Returns**               True       Cursor moved.  
                          False       Cursor not moved; the cursor is already at the beginning of the file.

**See**                   **Endfile**

## Begline

**Key** HOME

**Begline**

Places the cursor on the first nonblank character in the line.

**Meta Begline** (F9 HOME)

Places the cursor in the first character position of the line (column one).

**Returns** True Cursor moved.  
False Cursor not moved; the cursor is already at the destination.

**Example** The following macro moves the cursor to column one, then toggles between column one and the first nonblank character of the line.

```
toggle_begline := Left ->x Meta :>x Begline
```

The result of the **Left** function is tested to determine if the cursor is already in column one. If the cursor is in column one, PWB skips the **Meta** and executes **Begline** to move to the first nonblank character. If the cursor is not in column one, PWB executes **Meta Begline** to move there.

**Example** This macro mimics the behavior of the BRIEF HOME key:

```
bhome:= Meta Begline +> Home +> Begfile
```

The result of **Meta Begline** (go to column 1 on the line) is tested to determine if the cursor moved. If the cursor moved, the test (+>) succeeds and the macro exits. If the cursor did not move, the cursor is already in column 1, so the macro advances to the home position with **Home**. If the cursor did not move going to the home position, the macro advances to the beginning of the file with **Begfile**.

**See** **Left, Meta**

---

## Cancel

**Key** ESC

**Cancel**

Cancels the current selection, argument, or operation. If a message appears on the status bar, the **Cancel** function restores the original contents of the status bar.



If a dialog box or menu is open, **Cancel** closes the dialog box or menu and takes no further action. If Help on a dialog box, menu, or message box is being displayed, **Cancel** closes the Help dialog box.

**Returns** **Cancel** always returns true.

**See** **Arg**

---

## Cancelsearch

**Key** Unassigned

### Cancelsearch

Cancels a background search.

The Search Results window contains the partial results of the aborted search and is not flushed. You can browse matches listed in the Search Results by using the Next Match, Previous Match, and Goto Match commands from the Search menu and by using the **Nextsearch** function (Unassigned).

**Cancelsearch** applies only to multithreaded environments.

**Returns** True Background search was canceled.  
False No background search in progress.

**See** **Nextsearch**, **\_pwbnextlogmatch**, **\_pwbpreviouslogmatch**, **\_pwbgotomatch**

---

## Cdelete

**Key** CTRL+G

### Cdelete

Deletes the previous character, excluding line breaks. If the cursor is in column 1, **Cdelete** moves the cursor to the end of the previous line.

In insert mode, **Cdelete** deletes the previous character, reducing the line length by 1.

In overwrite mode, **Cdelete** deletes the previous character and replaces it with a space character. If the cursor is beyond the end of the line, the cursor moves to the immediate right of the last character on the line.

**Emacscdel** is similar to **Cdelete**. However, in insert mode, **Emacscdel** deletes line breaks; in overtype mode beyond the end of the line, it does not automatically move to the end of the line.

**Returns**            True        Cursor moved.  
                      False        Cursor not moved.

**See**                **Delete, Emacscdel, Ldelete, Sdelete**

---

## Clearmsg

**Key**                Unassigned

### **Clearmsg**

Clears the contents of the Build Results window.

### **Arg Clearmsg** (ALT+A Unassigned)

Clears the current set of messages in the Build Results window.

**Returns**            True        Cleared a message set or the contents of Build Results.  
                      False        The Build Results window is empty.

**See**                **Nextmsg, \_pwbnextmsg, \_pwbprevmsg, \_pwbsetmsg**

---

## Clearsearch

**Key**                Unassigned

### **Clearsearch**

Clears the contents of the Search Results window.

### **Arg Clearsearch** (ALT+A Unassigned)

Clears the current set of matches in the Search Results window.

**Returns**            True        Cleared a match set or the contents of Search Results.  
                      False        The Search Results window is empty.

**See**                **Clearmsg, Logsearch, \_pwbnextlogmatch, \_pwbpreviouslogmatch, \_pwbgotomatch**

## Closefile

**Key** Unassigned

### Closefile

Closes the file in the active window. If no files remain in the window's file history, the window is also closed.

### Arg Closefile (ALT+A Unassigned)

Closes the file named by the text at the cursor.

### Arg *linearg* | *boxarg* | *streamarg* Closefile

(ALT+A *linearg* | *boxarg* | *streamarg* Unassigned)

Closes the file named by the selected text.

### Arg *textarg* Closefile (ALT+A *textarg* Unassigned)

Closes the specified file.

**Returns** True The file was closed.  
False No file was closed.

**See** Refresh, `_pwbclosefile`

## Compile

**Key** CTRL+F3

The **Compile** function compiles and builds targets in the project or runs external commands, capturing the result of the operation in the Build Results window. Under multithreaded environments the commands run in the background.

### Arg Compile (ALT+A CTRL+F3)

Compiles the current file. This is equivalent to Project Compile File. **Arg Compile** fails if no project is open. See: `_pwbcompile`.

### Arg *textarg* Compile (ALT+A *textarg* CTRL+F3)

Builds the target specified by *textarg*. This is equivalent to Build Target command on the Project menu. **Arg *textarg* Compile** fails if no project is open.

To build the current project, execute **Arg a11 Compile**.

### Arg Meta *textarg* Compile (ALT+A *textarg* F9 CTRL+F3)

Rebuilds the specified target and its dependents. See: `_pwbrebuild`.

This command is equivalent to specifying the NMAKE /a option. Note that you can also include NMAKE command-line macro definitions in the text you pass to the **Compile** function.

**Arg Meta Compile** (ALT+A F9 CTRL+F3)

Aborts the background compile after prompting for confirmation. Also clears the queue of pending background operations (if any).

**Arg Arg *textarg* Compile** (ALT+A ALT+A *textarg* CTRL+F3)

Runs the program or operating-system command specified by *textarg*. The output is displayed in the Compile Results window.

Under multithreaded environments, the program runs in the background, and the Compile Results window is updated as the program executes. Several programs can be queued for background execution.

Do not use this command to execute an interactive program. The program is able to change the display but may not receive input. To run an interactive program, use the **Shell** function (SHIFT+F9).

**Returns**

True	Operation successfully initiated.
False	Operation not initiated.

---

## Copy

**Keys**

CTRL+INS, SHIFT+NUM\*

**Menu**

Edit menu, Copy command

**Copy**

Copies the current line to the clipboard.

**Arg Copy** (ALT+A CTRL+INS)

Copies text from the cursor to the end of the line. The text is copied to the clipboard, but the line break is not included.

**Arg *boxarg* | *linearg* | *streamarg* Copy**(ALT+A *boxarg* | *linearg* | *streamarg* CTRL+INS)

Copies the selected text to the clipboard.

**Arg *textarg* Copy** (ALT+A *textarg* CTRL+INS)

Copies the specified *textarg* to the clipboard.

**Arg *mark* Copy** (ALT+A *mark* CTRL+INS)

Copies the text from the cursor to the mark. The text is copied to the clipboard. The *mark* argument can be either a line number or a previously defined mark. See: **Mark**.

The text is copied as a *boxarg* or *linearg* depending on the relative positions of the cursor and the mark. If the cursor and the mark are in the same column, the text is copied as a *linearg*. If the cursor and the mark are in different columns, the text is copied as a *boxarg*.

**Arg number Copy** (ALT+A *number* CTRL+INS)

Copies the specified number of lines to the clipboard, starting with the current line. For example, **Arg 5 Copy** copies five lines to the clipboard.

**Returns** Copy always returns true.  
**See** Delete, Ldelete, Sdelete, Paste

---

## Curdate

**Key** Unassigned  
**Curdate**  
Types the current date at the cursor in the format *day-month-year*, for example: 17-Apr-1999.

**Returns** True Date typed.  
False Typing the date would make the line too long.

**See** Curday, Curfile, Curfilenam, Curfileext, Curtime

---

## Curday

**Key** Unassigned  
**Curday**  
Types the three-letter abbreviation for the current day of the week, as follows:  
Mon Tue Wed Thu Fri Sat Sun.

**Returns** True Day typed.  
False Typing the day would make the line too long.

**See** Curdate, Curfile, Curfilenam, Curfileext, Curtime

## Curtime

**Key** Unassigned

### Curtime

Types the current time in the format *hours:minutes:seconds*, for example, 17:08:32.

**Returns** True Time typed.  
False Typing the time would make the line too long.

**See** **Curdate, Curday, Curfile, Curfilenam, Curfileext**

---

## Delete

**Keys** SHIFT+DEL, SHIFT+NUM-

**Menu** Edit menu, Cut command

### Delete

Deletes the single character at the cursor, excluding line breaks. It does not copy the deleted character onto the clipboard. Note that the **Delete** function can delete more than one character, depending on the current selection mode.

### Arg Delete (ALT+A SHIFT+DEL)

Deletes from the cursor to the end of the line. The deleted text is copied onto the clipboard. In stream selection mode, the deletion includes the line break and joins the current line to the next line.

### Arg *boxarg* | *linearg* | *streamarg* Delete

(ALT+A *boxarg* | *linearg* | *streamarg* SHIFT+DEL)

Deletes the selected text. The text is copied on to the clipboard.

### Meta ... Delete (F9 ... SHIFT+DEL)

As above but discards the deleted text. The contents of the clipboard are not changed.

**Returns** **Delete** always returns true.

## Down

**Keys** DOWN, CTRL+X

### Down

Moves the cursor down one line. If a selection has been started, it is extended by one line. If this movement results in the cursor moving out of the window, the window is adjusted downward as specified by the **Vscroll** switch.

### Meta Down (F9 DOWN)

Moves the cursor to the bottom of the window without changing the column position.

**Returns** True Cursor moved.  
False Cursor did not move; the cursor is at the destination.

**See** Up

## Emacsdel

**Keys** BKSP, SHIFT+BKSP

### Emacsdel

Deletes the previous character. If the cursor is in column 1, **Emacsdel** moves the cursor to the end of the previous line.

In insert mode, **Emacsdel** deletes the previous character, reducing the length of the line by 1. If the cursor is in column one, **Emacsdel** deletes the line break, joining the current line to the previous line.

In overtype mode, **Emacsdel** deletes the previous character and replaces it with a space character. If the cursor is in column 1, **Emacsdel** moves the cursor to the end of the previous line and does not delete the line break.

**Emacsdel** is similar to **Cdelete**, but **Cdelete** never deletes line breaks; in overtype mode beyond the end of the line, **Cdelete** automatically moves to the end of the line.

**Returns** True Cursor moved.  
False Cursor not moved.

**See** **Cdelete**, **Delete**, **Ldelete**, **Sdelete**

## Emacsnewl

**Keys** ENTER, NUMENTER

**Emacsnewl**

In insert mode, starts a new line. In overwrite mode, moves the cursor to the beginning of the next line. PWB automatically positions the cursor on the new line, depending on the setting of the **Softer** switch.

**Returns** **Emacsnewl** always returns True.

**Update** In PWB 1.x, PWB performs special automatic indentation for C files. In PWB 2.00, language-specific automatic indentation is handled by language extensions if the feature is enabled. Otherwise, PWB uses its default indentation rules.

**See** **Newline, Softer, C\_Softer**

---

## Endfile

**Key** CTRL+END

**Endfile**

Places the cursor at the end of the file.

**Returns** True      Cursor moved.  
False      Cursor did not move; the cursor is at the end of the file.

**See** **Begfile**

---

## Endline

**Key** END

**Endline**

Moves the cursor to the immediate right of the last character on the line.

**Meta Endline** (F9 END)

Moves the cursor to the column that is one column past the active window width.



<b>Returns</b>	True	Cursor moved.
	False	Cursor did not move; the cursor is at the destination.
<b>See</b>	<b>Begline, Traildisp, Trailspace</b>	

---

## Environment

**Key** Unassigned

### Environment

Executes the current line as an environment-variable setting.

For example, if the current line contains the following text when you execute

**Environment:**

```
PATH=C:\UTIL;C:\DOS
```

PWB adds this setting to the current environment table. The effect is the same as the operating-system SET command. PWB uses the new environment variable for the rest of the session (including shells).

Depending on the settings of the **Envcursave** and **Envprojsave** switches, PWB saves the environment table for PWB sessions and/or projects.

See: **Envcursave, Envprojsave.**

**Arg *textarg* Environment** (ALT+A *textarg* Unassigned)

Executes the argument as an environment-variable setting.

**Arg *linearg* | *boxarg* Environment** (ALT+A *linearg* | *boxarg* Unassigned)

Executes each selected line or line fragment as an environment-variable setting.

**Meta Environment** (F9 Unassigned)

Performs environment-variable substitutions for all variables on the current line, replacing each variable with its value.

The syntax for an environment variable is INDEX: Environment variable, specifying in PWB

**\$(ENV) | \$ENV:**

where *ENV* is the uppercase name of the environment variable.

**Arg Meta Environment** (ALT+A F9 Unassigned)

Performs environment-variable substitutions (described above) for the text from the cursor to the end of the line.

**Arg *boxarg* | *linearg* | *streamarg* Meta Environment**

(ALT+A *boxarg* | *linearg* | *streamarg* F9 Unassigned)

Performs environment-variable substitutions for the selected text.

<b>Returns</b>	True	Environment variable successfully set or substituted.
	False	Syntax error or line too long.
<b>Update</b>		Because the <ENVIRONMENT> pseudofile no longer exists, this form of the <b>Environment</b> function is obsolete; it is replaced by the Environment command on the Options menu.

---

## Execute

**Key** F7

The **Execute** function executes PWB functions and macros by name. It allows you to execute commands that are not assigned to a key or execute a sequence of commands in one step.

The **Execute** function executes the commands by the same rules as macros. Function prompts are suppressed, and you can use the macro flow-control and macro prompt directives. You do not need to define a macro to use these features.

**Arg Execute** (ALT+A F7)

Executes the text from the cursor to the end of the line as a PWB macro.

**Arg linearg | textarg Execute** (ALT+A linearg | textarg F7)

Executes the specified text as a PWB macro.

<b>Returns</b>	True	Last executed function returned true.
	False	Last executed function returned false.

---

## Exit

**Key** F8

**Exit**

If you specified multiple files on the PWB command line, PWB advances to the next file. Otherwise, PWB quits and returns control to the operating system.

If the **Autosave** switch is set to yes, the file is saved if it has been modified. If **Autosave** is no and the file is modified, PWB prompts for confirmation to save the file.

**Meta Exit** (F9 F8)

Performs like **Exit** with the **Autosave** switch set to no, independent of the current setting of **Autosave**. If you have changed any files, PWB asks for confirmation to save before exiting.

**Arg Exit** (ALT+A F8)

Like **Exit**, except PWB quits immediately without advancing to the next file (if any).

**Arg Meta Exit** (ALT+A F9 F8)

Like **Meta Exit**, except PWB quits immediately without advancing to the next file.

**Returns** No return value.

**See** `_pwbquit`

## Graphic

**Keys** Assigned to most alphanumeric and punctuation keys.

**Graphic**

Types the character corresponding to the key that you pressed.

**Returns** True The character is typed.  
False Typing the character would make the line too long.

**See** **Assign, Quote**

## Home

**Key** GOTO (Numeric-keypad 5)

**Home**

Places the cursor in the upper-left corner of the window.

**Meta Home** (F9 GOTO)

Places the cursor in the lower-right corner of the window.

**Returns** True Cursor moved.  
False Cursor not moved; it is already at the destination.

**See** **Begline, Endline, Left, Right**

## Initialize

**Key**                   SHIFT+F8

### **Initialize**

Discards all current settings, including extension settings, then reads the statements from the [PWB] section of TOOLS.INI.

### **Arg Initialize** (ALT+A SHIFT+F8)

Reads the statements from a tagged section of TOOLS.INI. The tag name is specified by the continuous string of nonblank characters starting at the cursor.

### **Arg *textarg* Initialize** (ALT+A *textarg* SHIFT+F8)

Reads the statements from the TOOLS.INI tagged section specified by *textarg*.

**Example**                   The section tagged with  
[PWB-name]

is initialized by the command

Arg name Initialize

**Example**                   To reload the main section of TOOLS.INI without clearing other settings that you want to remain in effect, label the main section of TOOLS.INI with the tag:

[PWB PWB-main]

then use **Arg main Initialize** to recover your main settings instead of using **Initialize** with no arguments.

**Returns**               True        Initialized tagged section in TOOLS.INI.  
                  False       Did not find tagged section in TOOLS.INI.

---

## Information

**Update**               (obsolete)

The PWB 1.x **Information** function and its associated pseudofile <INFORMATION-FILE> are obsolete; they do not exist in PWB 2.00.

## Insert

<b>Key</b>	Unassigned
	<p><b>Insert</b>          Inserts a single-space character at the cursor, independent of the insert/overtyping mode.</p> <p><b>Arg Insert</b> (ALT+A Unassigned)          Breaks the line at the cursor.</p> <p><b>Arg <i>boxarg</i>   <i>linearg</i>   <i>streamarg</i> Insert</b>          (ALT+A <i>boxarg</i>   <i>linearg</i>   <i>streamarg</i> Unassigned)          Inserts space characters into the selected area.</p>
<b>Returns</b>	<p>True      Spaces or line break inserted.</p> <p>False     Insertion would make a line too long.</p>
<b>Example</b>	<p>If paragraphs in your file consist of a sequence of lines beginning in the same column and are separated from other paragraphs by at least one blank line, the following macro indents a paragraph to the next tab stop:</p> <pre>para_indent:=_pwbboxmode Meta Mpara Down Begline Arg \            Meta Ppara Up Begline Tab Insert</pre> <p>This macro starts with the predefined PWB macro <b>_pwbboxmode</b> to set box selection mode, then creates a box selection from the beginning of the paragraph to the end, one tab stop wide. The <b>Insert</b> function inserts spaces in the selection.</p>
<b>See</b>	<b>Sinsert, Linsert</b>

---

## Insertmode

<b>Keys</b>	INS, CTRL+V
	<p><b>Insertmode</b>          Toggles between insert mode and overtype mode. If overtype mode is on, the letter O appears on the status bar. The cursor can also change shape, depending on the <b>Cursormode</b> switch. See: <b>Cursormode</b>.</p> <p>In insert mode, each character you type is inserted at the cursor. This insertion shifts the remainder of the line one position to the right.</p> <p>In overtype mode, the character you type replaces the character at the cursor.</p>

**Returns**            True        PWB is in insert mode.  
                      False        PWB is in overtype mode.

---

## Lastselect

**Key**                CTRL+U

### **Lastselect**

Duplicates the last selection.

The Arg count and Meta state that were previously in effect are not duplicated—only the selection. The new Arg count is one, and the Meta state is the current Meta state. To use a higher Arg count, execute **Arg** (ALT+A). To toggle the Meta state, execute **Meta** (F9).

The re-created selection uses the same pair of *line:column* coordinates as the previous selection. Thus, different text can be selected if you have made additions or deletions to the file since the last selection.

**See**                 **Arg, Lasttext, Meta**

---

## Lasttext

**Key**                CTRL+O

### **Lasttext**

Displays the last text argument in the Text Argument dialog box. You can edit the text and then execute any PWB function that accepts a text argument, or you can cancel the dialog box.

If you edit the text and then cancel the dialog box, PWB retains the modified text. Thus, when you execute **Lasttext** again, the new text appears in the dialog box.

**Arg** [[Arg]]... [[Meta]] **Lasttext** (ALT+A [[ALT+A]]... [[F9]] CTRL+O)

Displays the last text argument in the Text Argument dialog box with the specified Arg count and Meta state.

**Arg** [[Arg]]... *linearg* | *boxarg* | *streamarg* [[Meta]] **Lasttext**

(ALT+A [[ALT+A]]... *linearg* | *boxarg* | *streamarg* [[F9]] CTRL+O)

Displays the first line of the selection in the Text Argument dialog box with the specified Arg count and Meta state.

**Returns**            The return value of **Lasttext** cannot be tested.

**Example**

The `OpenInclude` macro that follows opens an include file named in the next **#include** directive. The macro demonstrates a technique using the **Lasttext** function to pick up text from the file and modify it without modifying the file or the clipboard.

```
OpenInclude := \
  Up Meta Begline Arg Arg "[^\t]*#[\t]*include" Psearch -> \
  Arg Arg "[<>\""] Psearch -> Right Savecur Psearch -> \
  Selcur Lasttext Begline "$INCLUDE:" Openfile <n +> \
  Lastselect Openfile <
```

In the fourth line, **Lasttext** pulls the selected filename into the Text Argument dialog box. The text argument is modified to prepend `$INCLUDE:` before passing it to the **Openfile** function.

**Example**

In some macro-programming situations, you don't want to use the text immediately. Instead, you need to pick up some text, do some other processing, then use the text. In this situation, use the phrase:

*(make selection)* **Lasttext Cancel ...**

This picks up the text, then cancels the Text Argument dialog box. The selected text remains in the **Lasttext** buffer for later use. To reuse the text, call **Lasttext** again.

**See**

**Arg, Lastselect, Meta, Prompt**

## Ldelete

**Key**

CTRL+Y

**Ldelete**

Deletes the current line and copies it to the clipboard.

**Arg Ldelete** (ALT+A CTRL+Y)

Deletes text from the cursor to the end of the line and copies it to the clipboard.

**Arg mark Ldelete** (ALT+A *mark* CTRL+Y)

Deletes the text from the line at the cursor to the line specified by *mark* and copies it to the clipboard. The mark cannot be a line number.

**Arg number Ldelete** (ALT+A *number* CTRL+Y)

Deletes the specified number of lines starting from the line at the cursor and copies them to the clipboard.

**Arg** *boxarg* | *linearg* **Ldelete** (ALT+A *boxarg* | *linearg* CTRL+Y)

Deletes the specified text and copies it to the clipboard. The argument is a *linearg* or *boxarg* regardless of the current selection mode. The argument is a *linearg* if the starting and ending points are in the same column.

**Meta ... Ldelete** (F9 ... CTRL+Y)

As above but discards the deleted text. The clipboard is not changed.

**Returns** **Ldelete** always returns true.

**See** **Cdelete, Delete, Emacscdel, Sdelete**

---

## Left

**Keys** LEFT, CTRL+S

**Left**

Moves the cursor one character to the left. If this movement results in the cursor moving out of the window, the window is adjusted to the left as specified by the **Hscroll** switch.

**Meta Left** (F9 LEFT)

Moves the cursor to the first column in the window.

**Returns** True      Cursor moved.  
False      Cursor not moved; the cursor is in column one.

**See** **Begline, Down, Endline, Home, Right, Up**

---

## Linsert

**Key** CTRL+N

**Linsert**

Inserts one blank line above the current line.

**Arg Linsert** (ALT+A CTRL+N)

Inserts or deletes blanks at the beginning of a line to move the first nonblank character to the cursor.

**Arg boxarg** | *linearg* **Linsert** (ALT+A *boxarg* | *linearg* CTRL+N)

Inserts blanks within the specified area.



The argument is a *linearg* or *boxarg* regardless of the current selection mode. The argument is a *linearg* if the starting and ending points are in the same column.

**Arg mark Linsert** (ALT+A *mark* CTRL+N)

Like *boxarg* | *linearg* except the specified area is given by the cursor position and the position of the specified mark. The *mark* argument must be a named mark: it cannot be a line number. See: **Mark**.

**Returns** **Linsert** always returns true.

**See** **Insert, Sinsert**

## Logsearch

**Key** Unassigned

**Logsearch**

Toggles the search-logging state.

The default search-logging mode when PWB starts up is determined by the **Enterlogmode** switch.

**Returns** True Search logging turned on.  
False Search logging turned off.

## Mark

**Key** CTRL+M

The **Mark** function moves the cursor to a mark or specific location, defines marks, and deletes marks. Note that you cannot set a mark at specific text in a PWB window such as Help; PWB marks only the window position.

If you want to save marks between sessions, assign a filename to the **Markfile** switch or use the Set Mark File command on the Search menu.

**Mark** (CTRL+M)

Moves the cursor to the beginning of the file.

**Arg Mark** (ALT+A CTRL+M)

Restores the cursor to its location prior to the last window scroll. Use **Arg Mark** to return to your previous location after a search or other large jump.

**Arg number Mark** (ALT+A *number* CTRL+M)

Moves the cursor to the beginning of the line specified by *number* in the current file. Line numbering starts at 1.

**Arg textarg Mark** (ALT+A *textarg* CTRL+M)

Moves the cursor to the specified mark.

**Arg Arg textarg Mark** (ALT+A ALT+A *textarg* CTRL+M)

Defines a mark at the cursor position. The name of the mark is specified by *textarg*.

**Arg Arg textarg Meta Mark** (ALT+A ALT+A *textarg* F9 CTRL+M)

Deletes the specified mark. This form of the **Mark** function always returns true.

**Returns** True Move, definition, or deletion successful.  
False Invalid argument or mark not found.

**See** **Markfile, Restcur, Savecur, Selcur**

---

## Maximize

**Key** Unassigned

**Maximize**

Expands the window to its maximum size. If the window is already maximized, the window is restored.

When the window is maximized and scroll bars are turned off by using the **Winstyle** function, PWB turns off the window borders. This is the “clean screen” look.

**Meta Maximize** (F9 Unassigned)

Restores the window to its original size.

**Returns** True Window is maximized.  
False Window is restored.

**See** **Minimize, Winstyle**

---

## Menukey

**Key** ALT

### Menukey

Activates the menu bar. Unlike other PWB functions, **Menukey** can be assigned to only one key. It cannot be assigned to a combination of keys.

**Returns** You cannot test the return value of **Menukey**.

---

## Message

**Key** Unassigned

### Message

Clears the status bar.

### Arg Message (ALT+A Unassigned)

Displays the text from the cursor to the end of the line on the status bar.

### Arg *textarg* Message (ALT+A *textarg* Unassigned)

Displays *textarg* on the status bar.

### Meta ... Message (F9 ... Unassigned)

As above and also repaints the screen.

**Returns** **Message** always returns true.

**Example** The following macro is useful when writing new macros (the ! is the macro name):

```
! := Meta Message
```

With this definition you can place an exclamation point in your macros wherever you want a screen update. If you also want to display a status-bar message at the time of the update, use the phrase:

```
... Arg "text of message" ! ...
```

**See** **Prompt**

## Meta

**Key** F9

### Meta

Modifies the action of the function it prefixes.

When the Meta state is turned on, the letter A (for “Alternate”) appears in the status bar. You can use the **Meta** and **Arg** function prefixes in any order.

**Returns** True Meta state turned on.  
False Meta state turned off.

**See** **Arg**, **Lasttext**, **Lastselect**

---

## Mgrep

**Key** Unassigned

The **Mgrep** function searches all the files listed in the **Mgreplist** macro. PWB places all matches in the Search Results window. Under multithreaded environments, PWB performs the search in the background.

To browse the list of matches, use **\_pwbnextlogmatch** (CTRL+SHIFT+F3), **\_pwbpreviouslogmatch** (CTRL+SHIFT+F4), and the **Nextsearch** function (Unassigned).

### **Mgrep** (Unassigned)

Searches for the previously searched string or pattern.

### **Arg Mgrep** (ALT+A Unassigned)

Searches for the string specified by the characters from the cursor to the first blank character.

### **Arg textarg Mgrep** (ALT+A *textarg* Unassigned)

Searches for *textarg*.

### **Arg Arg Mgrep** (ALT+A ALT+A Unassigned)

Searches for the regular expression specified by the characters from the cursor to the first blank character.

### **Arg Arg textarg Mgrep** (ALT+A ALT+A *textarg* Unassigned)

Searches for the regular expression specified by *textarg*.

### **Meta ... Mgrep** (F9 ... Unassigned)

As above except that the value of the **Case** switch is reversed for the search.

---

<b>Returns</b>	<p>True With MS-DOS, indicates that a match was found. With multithreaded environments, indicates that a background search was successfully initiated.</p> <p>False No matches, no search pattern specified, search pattern invalid, or search terminated by CTRL+BREAK.</p>
<b>Update</b>	<p>In PWB 2.00, search and build results and their browsing functions are separate. A background build operation and a background search can be performed simultaneously.</p> <p>In PWB 1.x, search and build results appear in the same window, and are browsed with the same commands. A background build operation and a multifile search cannot be performed at the same time in PWB 1.x.</p>

---

## Minimize

<b>Key</b>	Unassigned
	<p><b>Minimize</b> Shrinks the active window to an icon (a minimized window). If the window is already minimized, restores the window.</p> <p><b>Arg Minimize</b> (ALT+A Unassigned) Minimizes all open windows.</p> <p><b>Meta Minimize</b> (F9 Unassigned) Restores the window to its unminimized state.</p>
<b>Returns</b>	<p>True Window minimized: the window is an icon. False Window restored: the window is not an icon.</p>
<b>See</b>	<b>Maximize</b>

---

## Mlines

<b>Keys</b>	CTRL+UP, CTRL+W
	<p><b>Mlines</b> Scrolls the window down as specified by the <b>Vscroll</b> switch.</p>

**Arg Mlines** (ALT+A CTRL+UP)

Scrolls the window so the line at the cursor moves to the bottom of the window.

**Arg number Mlines** (ALT+A *number* CTRL+UP)

Scrolls the window down by *number* lines.

**Returns** True Window scrolled.  
False Invalid argument.

**See** Plines

---

## Movewindow

**Key** Unassigned

**Movewindow**

Enters window-moving mode. In window-moving mode, only the following actions are available:

Action	Key
Move up one row	UP
Move down one row	DOWN
Move left one column	LEFT
Move right one column	RIGHT
Accept the new position	ENTER
Cancel the move	ESC

**Arg number Movewindow** (ALT+A *number* Unassigned)

Moves the upper-left corner of the window to the screen row specified by *number*.

**Meta Arg number Movewindow** (F9 ALT+A *number* Unassigned)

Moves the upper-left corner of the window to the screen column specified by *number*.

**Returns** True Window moved.  
False Window not moved.

---

## Mpage

**Keys** PGUP, CTRL+R

### **Mpage**

Moves the cursor backward in the file by one window.

**Returns** True Cursor moved.  
False Cursor not moved.

**See** **Ppage**

---

## Mpara

**Key** Unassigned

### **Mpara**

Moves the cursor to the beginning of the first line of the current paragraph. If the cursor is already on the first line of the paragraph, it is moved to the beginning of the first line of the preceding paragraph.

### **Meta Mpara** (F9 Unassigned)

Moves the cursor to the first blank line preceding the current paragraph.

**Returns** True Cursor moved.  
False Cursor not moved; no more paragraphs in the file.

**See** **Ppara**

---

## Mreplace

**Key** Unassigned

### **Mreplace**

Performs a find-and-replace operation across multiple files, prompting for the find-and-replacement strings and for confirmation at each occurrence.

**Mreplace** searches all the files listed in the special macro **Mgreplist**.

### **Arg Arg Mreplace** (ALT+A ALT+A Unassigned)

Performs the same action as **Mreplace** but uses regular expressions.

**Meta ... Mreplace** (F9 ... Unassigned)

As above except reverses the sense of the **Case** switch for the operation.

**Returns** True At least one replacement made.  
False No replacements made or operation aborted.

**See** **Mgrep, Mreplaceall, Qreplace, Replace**

---

## Mreplaceall

**Key** Unassigned

**Mreplaceall**

Performs a find-and-replace operation across multiple files, prompting for the find-and-replacement strings. **Mreplaceall** searches all the files listed in the special macro **Mgreplist**.

**Arg Arg Mreplaceall** (ALT+A ALT+A Unassigned)

Performs the same action as **Mreplaceall** but uses regular expressions.

**Meta ... Mreplaceall** (F9 ... Unassigned)

As above except reverses the sense of the **Case** switch for the operation.

**Returns** True At least one replacement made.  
False No replacements made or operation aborted.

**See** **Mgrep, Mreplace, Qreplace, Replace**

---

## Msearch

**Key** F4

**Msearch**

Searches backward for the previously searched string or pattern.

**Arg Msearch** (ALT+A F4)

Searches backward for the string specified by the text from the cursor to the first blank character.

**Arg textarg Msearch** (ALT+A textarg F4)

Searches backward for the specified text.



**Arg Arg Msearch** (ALT+A ALT+A F4)

Searches backward for the regular expression specified by the text from the cursor to the first blank character.

**Arg Arg *textarg* Msearch** (ALT+A ALT+A *textarg* F4)

Searches backward for the regular expression defined by *textarg*.

**Meta ... Msearch** (F9 ... F4)

As above except reverses the sense of the **Case** switch for the search.

**Returns** True String found.  
False Invalid argument, or string not found.

**See** **Mgrep, Psearch**

---

## Mword

**Keys** CTRL+LEFT, CTRL+A

**Mword**

Moves the cursor to the beginning of the current word, or if the cursor is not in a word or at the beginning of the word, moves the cursor to the beginning of the previous word. A word is defined by the **Word** switch.

**Meta Pword** (F9 CTRL+RIGHT)

Moves the cursor to the immediate right of the previous word.

**Returns** True Cursor moved.  
False Cursor not moved; there are no more words in the file.

**See** **Pword**

---

## Newfile

**Key** Unassigned

The **Newfile** function creates a new pseudofile. If the **Newwindow** switch is set to yes, it opens a new window for the file.

**Newfile** (Unassigned)

Creates a new untitled pseudofile. The new pseudofile is given a unique name of the form:

<Untitled.*nnn*>Untitled.*nnn*

where *nnn* is a three-digit number starting with 001 at the beginning of each PWB session. The window title shows `Untitled.001`. Use the pseudofile name `<Untitled.001>` to refer to the file in a text argument or dialog box.

**Arg Newfile** (ALT+A Unassigned)

Creates a new pseudofile with the name specified by the text from the cursor to the end of the line. The resulting full pseudofile name is:

"<Text on the line>Text on the line"

**Arg textarg Newfile** (ALT+A *textarg* Unassigned)

Creates a new pseudofile with the name specified by *textarg*. The resulting full pseudofile name is:

"<*textarg*>*textarg*"

If you want to use a different short name and window title, use the full name as an argument to the **Setfile** or **Openfile** functions. For example, **Arg**

"<temp>Temporary File" **Openfile** opens a pseudofile in a new window that has the title `Temporary File`.

**Returns**            True        Successfully created the pseudofile.  
                       False        Unable to create the pseudofile.

---

## Newline

**Keys**                SHIFT+ENTER, SHIFT+NUMENTER

**Newline**

Moves the cursor to a new line.

If the **Softcr** switch is set to yes, PWB automatically indents to an appropriate position based on the type of file you are editing.

**Meta Newline** (F9 SHIFT+ENTER)

Moves the cursor to column 1 of the next line.

**Returns**            Newline always returns true.

**Update**            In PWB 1.x, PWB performs special automatic indentation for C files. In PWB 2.00, language-specific automatic indentation is handled by language extensions if the feature is enabled. Otherwise, PWB uses its default indentation rules.

**See**                 **Emacsnewl**

## Nextmsg

<b>Key</b>	<p>Unassigned</p> <p><b>Nextmsg</b> Advances to next message in the Build Results window.</p> <p><b>Arg number Nextmsg</b> (ALT+A <i>number</i> Unassigned) Moves to the <i>n</i>th message in the current set of messages, where <i>n</i> is specified by <i>number</i>.</p> <p>To move relative to the current message, use a signed number. For example, when <i>number</i> is +1, PWB moves to the next message, and when it is -1, PWB moves to the previous message.</p> <p><b>Arg Nextmsg</b> (ALT+A Unassigned) Moves to the next message in the current set of messages that does not refer to the current file.</p> <p><b>Meta Nextmsg</b> (F9 Unassigned) Advances to the next set of messages.</p> <p><b>Arg Arg Nextmsg</b> (ALT+A ALT+A Unassigned) Sets the message at the cursor as the current message. This works only when the cursor is on a message in the Build Results window.</p>
<b>Returns</b>	<p>True      Message found.</p> <p>False     No more messages found.</p>
<b>Update</b>	<p>In PWB 1.x, <b>Nextmsg</b> also browses the results of searches. In PWB 2.00, search results are browsed with the <b>Nextsearch</b> function.</p> <p><b>Meta Nextmsg</b> In PWB 1.x, deletes the current set of messages and advances to the next set. In PWB 2.00, <b>Meta Nextmsg</b> does not delete the set. To delete sets of messages in PWB 2.00, use the <b>Clearmsg</b> function.</p> <p><b>Meta Arg Arg Nextmsg</b> In PWB 1.x, closes the Compile Results window. In PWB 2.00, it behaves like <b>Arg Arg Nextmsg</b>.</p>
<b>See</b>	Clearmsg

## Nextsearch

**Key** Unassigned

### **Nextsearch**

Advances to the next match in the Search Results window.

### **Arg number Nextsearch** (ALT+A *number* Unassigned)

Moves to the *n*th match in the current set of matches, where *n* is specified by *number*.

To move relative to the current match, use a signed number. For example, when *number* is +1, PWB moves to the next match, and when it is -1, PWB moves to the previous match.

### **Arg Nextsearch** (ALT+A Unassigned)

Moves to the next match in the current set of matches that does not refer to the current file.

### **Meta Nextsearch** (F9 Unassigned)

Advances to the next set of matches.

### **Arg Arg Nextsearch** (ALT+A ALT+A Unassigned)

Sets the match at the cursor as the current match. This works only when the cursor is on a match in the Search Results window.

**Update** In PWB 1.x, the results of searches are browsed using the **Nextmsg** function.

**See** **Clearsearch**

---

## Noedit

**Key** Unassigned

The **Noedit** function toggles the no-edit state of PWB or the current file. When the no-edit state is turned on, PWB displays the letter R on the status bar and disallows modification of the file.

### **Noedit**

Toggles the no-edit state. If you started PWB with the /R (read-only) option, **Noedit** removes the no-edit limitation.

### **Meta Noedit** (F9 Unassigned)

Toggles the no-edit state for the current file. This form of the **Noedit** command works only for disk files and has no effect on pseudofiles.

If you have the **Editreadonly** switch set to no, PWB turns on the no-edit state for files that are marked read-only on disk. This function toggles the no-edit state for the file so that you can modify it.

<b>Returns</b>	True	File or PWB in no-edit state; modification disallowed.
	False	File or PWB not in no-edit state; modification allowed.

---

## Openfile

**Key** F10

The **Openfile** function opens a file in a new window, ignoring the **Newwindow** switch.

**Arg Openfile** (ALT+A F10)

Opens the file at the cursor in a new window. The name of the file is specified by the text from the cursor to the first blank character.

**Arg *textarg* Openfile** (ALT+A *textarg* F10)

Opens the specified file in a new window.

If the argument is a wildcard, PWB creates a pseudofile containing a list of files that match the pattern. To open a file from this list, position the cursor at the beginning of the name and use **Arg Openfile** or **Arg Setfile**.

<b>Returns</b>	True	File and window successfully opened.
	False	No argument specified, or file did not exist and you did not create it.

**See** **Newfile**, **Setfile**

---

## Paste

**Keys** SHIFT+INS, SHIFT+NUM+

**Menu** Edit menu, Paste command

**Paste** (SHIFT+INS)

Copies the contents of the clipboard to the file at the cursor. The text is always inserted independent of the insert/overtyping mode.

If the clipboard contents were copied to the clipboard as a *linearg*, PWB inserts the contents of the clipboard above the current line. Otherwise, the contents of the clipboard are inserted at the cursor.

**Arg** *boxarg* | *linearg* | *streamarg* **Paste**(ALT+A *boxarg* | *linearg* | *streamarg* SHIFT+INS)

Replaces the selected text with the contents of the clipboard.

**Arg Paste** (ALT+A SHIFT+INS)

Copies the text from the cursor to the end of the line. The text is copied to the clipboard and inserted at the cursor.

**Arg** *textarg* **Paste** (ALT+A *textarg* SHIFT+INS)Copies *textarg* to the clipboard and inserts it at the cursor.**Arg Arg** *filename* **Paste** (ALT+A ALT+A *filename* SHIFT+INS)Copies the contents of the file specified by *textarg* to the current file above the current line.**Arg Arg !textarg Paste** (ALT+A ALT+A *!filename* SHIFT+INS)Runs *textarg* as an operating-system command, capturing the command's output to standard output. The output is copied to the clipboard and inserted above the current line.

You must enter the exclamation mark as shown.

**Returns**True **Paste** always returns true except for the following cases.False Tried **Arg Arg filename Paste** and file did not exist, or the pasted text would make a line too long.**Example**

The following command copies a sorted copy of the file SAMPLE.TXT to the current file: **Arg Arg !SORT <SAMPLE.TXT Paste** (ALT+A ALT+A !SORT <SAMPLE.TXT SHIFT+INS).

## Pbal

**Key**

CTRL+[

**Pbal**

Scans backward through the file, balancing parentheses ( ( ) ) and brackets ( [ ] ). The first unmatched parenthesis or bracket is highlighted when found.

If an unbalanced parenthesis or bracket is found, it is highlighted and the corresponding character is inserted at the cursor. If no unbalanced characters are found, PWB displays a message box.

The search does not include the cursor position and looks for more opening brackets or parentheses than closing ones.

**Arg Pbal** (ALT+A CTRL+[)

Like **Pbal** except that it scans forward through the file and searches for right brackets or parentheses lacking opening partners.

**Meta Pbal** (F9 CTRL+[)

Like **Pbal** but does not insert the unbalanced character. If no unbalanced characters are found, moves to the matching character.

**Arg Meta Pbal** (ALT+A F9 CTRL+[)

Like **Arg Pbal** but does not insert the character. If no unbalanced characters are found, moves to the matching character.

**Update**

In PWB 1.x, the messages appear on the status bar. In PWB 2.00, they appear in a message box.

**Returns**

True        Balance successful.  
False      Invalid argument, or no unbalanced characters found.

**See**

**Infodialog**

---

## Plines

**Keys**

CTRL+DOWN, CTRL+Z

**Plines**

Scrolls the text up as specified by the **Vscroll** switch.

**Arg Plines** (ALT+A CTRL+DOWN)

Scrolls the text such that the line at the cursor is moved to the top of the window.

**Arg number Plines** (ALT+A *number* CTRL+DOWN)

Scrolls the text up by *number* lines.

**Returns**

True        Text scrolled.  
False      Invalid argument.

**See**

**Mlines**

---

## Ppage

**Keys**

PGDN, CTRL+C

**Ppage**

Moves the cursor forward in the file by one window.

**Returns**            True      Cursor moved.  
                      False     Cursor not moved.

**See**                **Mpage**

---

## Ppara

**Key**                Unassigned

### **Ppara**

Moves the cursor to the beginning of the first line of the next paragraph.

### **Meta Ppara** (F9 Unassigned)

Moves cursor to the beginning of the first blank line after the current paragraph. If the cursor is not on a paragraph, moves the cursor to the first blank line after the next paragraph.

**Returns**            True      Cursor moved.  
                      False     Cursor not moved; no more paragraphs in the file.

**See**                **Mpara**

---

## Print

**Key**                Unassigned

The **Print** function prints files or selections. If the **Printcmd** switch is set, PWB uses the command line given in the switch. Otherwise, PWB copies the file or selection to PRN. Under multithreaded environments, PWB runs the print command in the background.

### **Print** (Unassigned)

Prints the current file.

### **Arg textarg Print** (ALT+A *textarg* Unassigned)

Prints all the files listed in *textarg*. Use a space to separate each name from the preceding name. You can use environment variables to specify paths for the files.

### **Arg boxarg | linearg | streamarg Print**

(ALT+A *boxarg | linearg | streamarg* Unassigned)

Prints the selected text.



**Arg Meta Print** (ALT+A F9 Unassigned)

Cancels the current background print.

<b>Returns</b>	True	Print successfully submitted.
	False	Could not start print job.
<b>Update</b>	In PWB 1.x there is no way to cancel a background print.	

## Project

**Key** Unassigned

**Project**

Open the last project.

**Arg Project** (ALT+A Unassigned)

Open the project makefile at the cursor as a PWB project. The name of the project is specified by the text from the cursor to the first blank character.

**Arg *textarg* Project** (ALT+A *textarg* Unassigned)

Open the project makefile specified by *textarg* as a PWB project.

**Arg Arg Project** (ALT+A ALT+A Unassigned)

Close the current project.

**Arg Meta Project** (ALT+A F9 Unassigned)

Open the project makefile at the cursor as a non-PWB project (foreign makefile).

**Arg *textarg* Meta Project** (ALT+A *textarg* F9 Unassigned)

Open the project makefile specified by *textarg* as a non-PWB project.

<b>Returns</b>	True	A project is open.
	False	A project is not open.

**See** **Lastproject**

## Prompt

**Key** Unassigned

The **Prompt** function displays the Text Argument dialog box where you can enter a text argument. You can use this function interactively, but because it is mainly

useful in macros, it is not assigned to a key by default. You usually use **Lasttext** or **Arg** to directly enter a text argument.

**Prompt**

Displays the Text Argument dialog box without a title. See: **Lasttext**

**Arg Prompt** (ALT+A Unassigned)

Uses the text of the current line from the cursor to the end of the line as the title.

**Arg *textarg* Prompt** (ALT+A *textarg* Unassigned)

Uses *textarg* as the title.

**Arg *boxarg* | *linearg* | *streamarg* Prompt**

(ALT+A *boxarg* | *linearg* | *streamarg* Unassigned)

Uses the selected text as the title. If the selection spans more than one line, the title is the first line of the selected text.

**Returns**

True      Textarg entered; the user chose the OK button.

False     The dialog box was canceled.

**Example**

With the following macro, PWB prompts for a Help topic:

```
QueryHelp := Arg "Help Topic to Find:" Prompt -> Pwbhelp
QueryHelp : Ctrl+Q
```

When you press CTRL+Q, PWB displays a dialog box with the string `Help Topic to Find:` as the title and waits for a response. PWB passes your response to the **Pwbhelp** function as if the command **Arg *textarg* Pwbhelp** had been executed. If you cancel the dialog box, **Prompt** returns false and the macro conditional `->` terminates the macro without executing **Pwbhelp**.

**See**

**Assign**

---

## Psearch

**Key**

F3

**Psearch**

Searches forward for the previously searched string or pattern.

**Arg Psearch** (ALT+A F3)

Searches forward in the file for the string specified by the text from the cursor to the first blank character.

**Arg *textarg* Psearch** (ALT+A *textarg* F3)

Searches forward for the specified text.

**Arg Arg Psearch** (ALT+A ALT+A F3)

Searches forward in the file for the regular expression specified by the text from the cursor to the first blank character.

**Arg Arg *textarg* Psearch** (ALT+A ALT+A *textarg* F3)

Searches forward for the regular expression defined by *textarg*.

**Meta ... Psearch** (F9 ... F3)

As above but reverses the value of the **Case** switch for one search.

<b>Returns</b>	True	String found.
	False	Invalid argument, or string not found.

---

## Pwbhelp

**Key** Unassigned

**Pwbhelp**

Displays the default Help topic.

**Arg Pwbhelp** (ALT+A Unassigned)

Displays Help on the topic at the cursor. Equivalent to the macro **\_pwbhelp\_context** (F1).

**Arg *textarg* Pwbhelp** (ALT+A *textarg* Unassigned)

Displays Help on the specified text argument.

**Arg *streamarg* Pwbhelp** (ALT+A *streamarg* Unassigned)

Displays Help on the selected text. The selection cannot include more than one line.

**Meta Pwbhelp** (F9 Unassigned)

Prompts for a key, then displays Help on the function or macro assigned to the key you press.

If you press a key that is not assigned to a function or macro, PWB displays help on the **Unassigned** function. If you press a key that PWB does not recognize, the prompt remains displayed until you press a key that PWB recognizes.

<b>Returns</b>	True	Help topic found.
	False	Help topic not found.

## Pwbhelpnext

**Key** CTRL+F1

### **Pwbhelpnext**

Displays the next physical topic in the current Help database.

### **Meta Pwbhelpnext** (F9 CTRL+F1)

Displays the previous Help topic on the backtrace list. This is the Help topic that you previously viewed. Up to 20 Help topics are retained in the backtrace list.

Equivalent to the Back button on the Help screens and the macro **\_pwbhelp\_back** (ALT+F1).

### **Arg Pwbhelpnext** (ALT+A CTRL+F1)

Displays the next occurrence of the current Help topic within the Help system.

Equivalent to the macro **\_pwbhelp\_again** (Unassigned).

Use this command when the Help topic appears several times in the set of open Help databases.

**Returns** True Help topic found.  
False Help topic not found.

## Pwbhelpsearch

**Key** Unassigned

The **Pwbhelpsearch** function performs a global search of the Help system. The search is case insensitive unless you use the **Meta** form of **Pwbhelpsearch**, which uses the setting of the **Case** switch to determine case sensitivity.

### **Pwbhelpsearch** (Unassigned)

Displays the results of the last global Help search.

Equivalent to the predefined macro **\_pwbhelp\_searchres** (Unassigned).

### **Arg Pwbhelpsearch** (ALT+A Unassigned)

Searches Help for the word at the cursor.

### **Arg *textarg* Pwbhelpsearch** (ALT+A *textarg* Unassigned)

Searches Help for the selected text.

### **Arg Arg Pwbhelpsearch** (ALT+A ALT+A Unassigned)

Searches Help using the regular expression at the cursor.

### **Arg Arg *textarg* Pwbhelpsearch** (ALT+A ALT+A *textarg* Unassigned)

Searches Help for the selected regular expression.

**Meta ... Pwbhelpsearch** (F9 ... Unassigned)

As above except the search is case sensitive if the **Case** switch is set to yes.

<b>Returns</b>	True	At least one match found.
	False	No matches found, or search canceled.

---

## Pwbrowse Functions

Most of the **Pwbrowse...** functions provided by the PWBROWSE Source Browser extension display one of the Source Browser's dialog boxes. The Source Browser functions attached to Browse menu commands are listed in the following table.

<b>Function</b>	<b>Browse Menu Command</b>	<b>Key</b>
Pwbrowsealltree	Call Tree (Fwd/Rev)	Unassigned
Pwbrowseclhier	Class Hierarchy	Unassigned
Pwbrowsecltree	Class Tree (Fwd/Rev)	Unassigned
Pwbrowsefuhier	Function Hierarchy	Unassigned
Pwbrowsegotodef	Goto Definition	Unassigned
Pwbrowsegotoref	Goto Reference	Unassigned
Pwbrowselistref	List References	Unassigned
Pwbrowsenext	Next	CTRL+NUM+
Pwbrowseoutline	Module Outline	Unassigned
Pwbrowseprev	Previous	CTRL+NUM-
Pwbrowseviewrel	View Relationship	Unassigned
Pwbrowsewhref	Which Reference	Unassigned

The browser functions in the following table do not correspond to a Browse menu command.

<b>Function</b>	<b>Description</b>	<b>Key</b>
Pwbrowse1stdef	Go to 1st definition	Unassigned
Pwbrowse1stref	Go to 1st reference	Unassigned
Pwbrowsepop	Go to previously browsed location	Unassigned

## Pwbwindow

**Key** Unassigned

The **Pwbwindow** function opens PWB windows. If the specified window is already open, PWB switches to that window.

**Arg Pwbwindow** (ALT+A Unassigned)

Opens the PWB window with the name at the cursor. The name is specified by the text from the cursor to the first blank character.

**Arg *textarg* Pwbwindow** (ALT+A *textarg* Unassigned)

Opens the specified PWB window.

**Arg Meta Pwbwindow** (ALT+A F9 Unassigned)

Closes the PWB window specified by the name at the cursor.

**Arg *textarg* Meta Pwbwindow** (ALT+A *textarg* F9 Unassigned)

Closes the specified PWB window.

**Returns** True The specified window was opened.  
False The window could not be opened.

---

## Pword

**Keys** CTRL+RIGHT, CTRL+F

**Pword**

Moves the cursor to the beginning of the next word. A word is defined by the **Word** switch.

**Meta Pword** (F9 CTRL+RIGHT)

Moves the cursor to the immediate right of the current word, or if the cursor is not in a word, moves it to the right of the next word.

**Returns** True Cursor moved.  
False Cursor not moved; there are no more words in the file.

**See** **Mword**

## Qreplace

### Key

CTRL+V

The **Qreplace** function performs a find-and-replace operation on the current file, prompting for find-and-replacement strings and confirmation at each occurrence.

### Qreplace (CTRL+V)

Performs the replacement from the cursor to the end of the file, wrapping around the end of the file if the **Searchwrap** switch is set to yes.

### Arg *boxarg* | *linearg* | *streamarg* Qreplace

(ALT+A *boxarg* | *linearg* | *streamarg* CTRL+V)

Performs the replacement over the selected area.

Note that PWB does not adjust the selection at each replacement for changes in the length of the text. For *boxarg* and *streamarg*, PWB may replace text that was not included in the original selection or miss text included in the original selection.

### Arg *mark* Qreplace (ALT+A *mark* CTRL+V)

Performs the replacement on text from the cursor to the specified mark.

Replaces over text as if it were selected, according to the current selection mode.

The *mark* argument cannot be a line number. See: **Mark**.

### Arg *number* Qreplace (ALT+A *number* CTRL+V)

Performs the replacement for the specified number of lines, starting with the line at the cursor.

### Arg Arg ... Qreplace (ALT+A ALT+A ... CTRL+V)

As above except using regular expressions.

### Meta ... Qreplace (F9 ... CTRL+V)

As above except the sense of the **Case** switch is reversed for the operation.

### Returns

True At least one replacement was performed.

False String not found, or invalid pattern.

### See

**Mreplace**, **Replace**, **Searchwrap**

## Quote

**Key** CTRL+P

### Quote

Reads one key from the keyboard and types it into the file or dialog box. In a dialog box, the key is always CTRL+P, no matter what function or macro you may have assigned to CTRL+P for the editor.

This is useful for typing a character (such as TAB or CTRL+L) whose keystroke is assigned to a PWB function.

**Returns** True **Quote** always returns true except in the following case.  
False Character would make line too long.

---

## Record

**Key** SHIFT+CTRL+R

The **Record** function toggles macro recording. While a macro is being recorded, PWB displays the letter X on the status bar, and a bullet appears next to the Record On command from the Edit menu. If a menu command cannot be recorded, it is disabled while recording.

When macro recording is stopped, PWB assigns the recorded commands to the default macro name **Playback**. During the recording, PWB writes the name of each command to the definition of **Playback** in the Record window, which can be viewed as it is updated.

Macro recording in PWB does not record changes in cursor position accomplished by clicking the mouse. Use the keyboard if you want to include cursor movements in a macro.

### **Record** (SHIFT+CTRL+R)

Toggles macro recording on and off.

### **Arg textarg Record** (ALT+A textarg SHIFT+CTRL+R)

Turns on recording if it is off and assigns the name specified in the text argument to the recorded macro. Turns off recording if it is turned on.

### **Meta Record** (F9 SHIFT+CTRL+R)

Toggles macro recording. While recording, no editing commands are executed until recording is turned off. Use this form of the function to record a macro without modifying your file.



**Arg Record** (ALT+A SHIFT+CTRL+R)

**Arg Arg *textarg* Record** (ALT+A ALT+A *textarg* SHIFT+CTRL+R)

**Arg Arg Meta Record** (ALT+A ALT+A F9 SHIFT+CTRL+R)

As above but if the target macro already exists, the commands are appended to the end of the macro.

<b>Returns</b>	True	Recording turned on.
	False	Recording turned off.

**Update** In PWB 2.00, more menu commands can be recorded than with PWB 1.x.

## Refresh

**Key** SHIFT+F7

### Refresh

Prompts for confirmation and then rereads the file from disk, discarding its Undo history and all modifications to the file since the file was last saved.

<b>Returns</b>	<b>Condition</b>
True	File reread.
False	Prompt canceled

**Arg Refresh** (ALT+A SHIFT+F7)

Prompts for confirmation and then removes the file from the active window and the window's file history. If the active window is the last window that has the file in its history, the file is discarded from memory without saving changes, and the file is closed.

<b>Returns</b>	<b>Condition</b>
True	File removed from the window.
False	Prompt canceled, or bad argument. The file is not removed from the window.

## Repeat

**Key** Unassigned

### Repeat

Repeats the last editing action relative to the current cursor position. The **Repeat** function considers the following types of operations to be editing actions:

- ◆ Typing a contiguous stream of characters without entering a command or moving the cursor
- ◆ Deleting text
- ◆ Pasting from the clipboard

**Repeat** does not repeat macros or cursor movements.

**Arg** *number Repeat* (ALT+A *number* Unassigned)

Performs the last action the number of times specified by *number*.

**Returns** True Action repeated and returned true.  
False Action repeated and returned false, or no action to repeat.

---

## Replace

**Key** CTRL+L

The **Replace** function performs a find-and-replace operation on the current file, prompting for find and replacement strings. **Replace** substitutes all matches of the search pattern without prompting for confirmation.

### Replace (CTRL+L)

Performs the replacement from the cursor to the end of the file, wrapping around the end of the file if the **Searchwrap** switch is on.

**Arg** *boxarg | linearg | streamarg Replace*  
(ALT+A *boxarg | linearg | streamarg* CTRL+L)

Performs the replacement over the selected area.

Note that PWB does not adjust the selection at each replacement for changes in the length of the text. For *boxarg* and *streamarg*, PWB may replace text that was not included in the original selection or miss text included in the original selection.

**Arg mark Replace** (ALT+A *mark* CTRL+L)

Performs the replacement on text from the cursor to the specified mark. It searches the range of text as if it were selected, according to the current selection mode. The *mark* argument cannot be a line number.

**Arg number Replace** (ALT+A *number* CTRL+L)

Performs the replacement over the specified number of lines, starting with the current line.

**Arg Arg ... Replace** (ALT+A ALT+A ... CTRL+L)

As above except using regular expressions.

**Meta ... Replace** (F9 ... CTRL+L)

As above except the sense of the **Case** switch is reversed for the operation.

**Returns**

True        At least one replacement was performed.  
False       String not found, or invalid pattern.

**See**

**Qreplace**, **Searchwrap**

**Example**

To use the replace function in a macro, use the phrase:

```
...Replace "pattern" Newline "replacement" Newline +>found...
```

Enter the replies to the prompts as you would when executing **Replace** interactively. This example also shows where to place the conditional to test the result of **Replace**.

You can specify special characters in the find-and-replacement strings by using escape sequences similar to those in the C language. Note that backslashes in the macro string must be doubled.

To restore the usual prompts, use the phrase:

```
...Replace <
```

To use an empty replacement text (replace with nothing), use the following phrase:

```
...Replace "pattern" Newline " " Cdelete Newline...
```

If you find that you write many macros with empty replacements, the common phrase can be placed in a macro, as follows:

```
nothing := " " Cdelete Newline
```

In addition, macro definitions can be more readable with the following definition:

```
with := Newline
```

With these definitions, you can write:

```
... Replace "pattern" with nothing ...
```

## Resize

**Key** Unassigned

### Resize

Enters window-resizing mode. When in window-resizing mode, only the following actions are available:

Action	Key
Shrink one row	UP
Expand one row	DOWN
Shrink one column	LEFT
Expand one column	RIGHT
Accept the new size	ENTER
Cancel the resize	ESC

**Arg number Resize** (ALT+A *number* Unassigned)

Resizes the window to *number* rows high.

**Arg number Meta Resize** (ALT+A *number* F9 Unassigned)

Resizes the window to *number* columns wide.

**See** **Movewindow**

---

## Restcur

**Key** Unassigned

### Restcur

Moves the cursor to the last position saved with the **Savecur** function (Unassigned, Set To Anchor command, Edit menu). **Restcur** always clears the saved position.

**Returns** True Position restored.  
False No saved position to restore.

**See** **Selcur**

## Right

**Keys** RIGHT, CTRL+D

### **Right**

Moves the cursor one character to the right. If this action causes the cursor to move out of the window, PWB adjusts the window to the right according to the **Hscroll** switch.

### **Meta Right** (F9 RIGHT)

Moves the cursor to the rightmost position in the window.

**Returns** True Cursor on text in the line.  
False Cursor past text on the line.

**Example** In a macro, the return value of the **Right** function can be used to test if the cursor is on text in the line or past the end of the line.

The following macro tests the return value to simulate the **Endline** function:

```
MyEndline := Begline :>loop Right +>loop
```

**See** **Begline, Endfile, Endline, Home, Left**

---

## Saveall

**Key** Unassigned

### **Saveall**

Saves all modified disk files. Pseudofiles are not saved.

**Returns** **Saveall** always returns true.

---

## Savecur

**Key** Unassigned

**Menu** Edit menu, Set Anchor command

### **Savecur**

Saves the cursor position (sets an anchor).

To restore the cursor to the saved position, use the **Restcur** function (Unassigned). To select text from the current position to the saved position, use the Select To Anchor command from the Edit menu or the **Selcur** function (Unassigned).

**Returns**            **Savecur** always returns true.

---

## Sdelete

**Key**                Unassigned

### **Sdelete**

Deletes the character at the cursor. Does not copy the character to the clipboard.

### **Arg Sdelete** (ALT+A Unassigned)

Deletes text from the cursor to the end of the line, including the line break. The deleted text is copied to the clipboard.

### **Arg streamarg | boxarg | linearg Sdelete**

(ALT+A *streamarg | boxarg | linearg* Unassigned)

Deletes the selected stream of text from the starting point of the selection to the cursor and copies it to the clipboard. Always deletes a stream, regardless of the current selection mode.

### **Meta ... Sdelete** (F9 ... Unassigned)

As above but discards the deleted text. The contents of the clipboard are unchanged.

**Returns**            **Sdelete** always returns true.

---

## Searchall

**Key**                Unassigned

### **Searchall**

Highlights all occurrences of the previously searched string or pattern. Moves the cursor to the first occurrence in the file.

### **Arg Searchall** (ALT+A Unassigned)

Highlights all occurrences of the string specified by the text from the cursor to the first blank character.

**Arg *textarg* Searchall** (ALT+A *textarg* Unassigned)

Highlights all occurrences of *textarg*.

**Arg Arg Searchall** (ALT+A ALT+A Unassigned)

Highlights all occurrences of the regular expression defined by the characters from the cursor to the first blank character.

**Arg *streamarg* Searchall** (ALT+A *streamarg* Unassigned)

Highlights all occurrences of *streamarg*.

**Arg Arg *textarg* Searchall** (ALT+A ALT+A *textarg* Unassigned)

Highlights all occurrences of a regular expression defined by *textarg*.

**Meta ... Searchall** (F9 ... Unassigned)

As above but reverses the value of the **Case** switch for one search.

**Returns**

True	String or pattern found.
False	No matches found.

## Selcur

**Key** Unassigned

**Menu** Edit menu, Select To Anchor command

### Selcur

Selects text from the cursor to the position saved using the Set Anchor command from the Edit menu or the **Savecur** function (Unassigned). If no position has been saved, **Selcur** selects text from the cursor to the beginning of the file.

**Returns** **Selcur** always returns true.

## Select

**Keys** SHIFT+PGUP, SHIFT+CTRL+PGUP, SHIFT+PGDN, SHIFT+CTRL+PGDN, SHIFT+END, SHIFT+CTRL+END, SHIFT+HOME, SHIFT+CTRL+HOME, SHIFT+LEFT, SHIFT+CTRL+LEFT, SHIFT+UP, SHIFT+RIGHT, SHIFT+CTRL+RIGHT, SHIFT+DOWN

### Select

Causes a shifted key to take on the cursor-movement function associated with the unshifted key and begins or extends a selection.

To see the key combinations currently assigned to this function, use the Key Assignments command from the Options menu.

## Selmode

**Key** Unassigned

### Selmode

Advances the selection mode between stream, line, and box modes, starting with the current mode.

**Returns** True New mode is stream mode.  
False New mode is box mode or line mode.

**See** `_pwbstreammode`, `_pwbboxmode`, `_pwblinemode`

---

## Selwindow

**Key** F6

### Selwindow

Moves the focus to the next window.

### Arg Selwindow (ALT+A F6)

Moves the focus to the next unminimized window. Minimized windows (icons) are skipped.

### Arg *number* Selwindow (ALT+A *number* F6)

Moves the focus to the specified window.

### Meta Selwindow (F9 F6)

Moves the focus to the previous window.

### Arg Meta Selwindow (ALT+A F9 F6)

Moves the focus to the previous unminimized window.

**Returns** True Focus moved to another window.  
False No other windows are open.



# Setfile

**Key** F2

## Setfile

Switches to the first file in the active window's file history. If there are no files in the file history, PWB displays the message `No alternate file`. When the **Autosave** switch is set to yes, PWB saves the current file if it has been modified.

**Setfile** does not honor the **Newwindow** switch. To open a new window when you open a file, use **Openfile**.

### Arg Setfile (ALT+A F2)

Switches to the filename that begins at the cursor and ends with the first blank character.

### Arg *textarg* Setfile (ALT+A *textarg* F2)

Switches to the file specified by *textarg*. If the file is not already open, PWB opens it. You can use environment-variable specifiers in the argument.

If the argument is a drive or directory name, PWB changes the current drive or directory to the specified one and displays a message to confirm the change. See: **Infodialog**.

### Arg *!number* Setfile (ALT+A *!number* F2)

If the argument has the form *!number*, PWB switches to the file with that number in the file history. The number can be from 1 to 9, inclusive. See: **\_pwbfile**.

### Arg *wildcard* Setfile (ALT+A *wildcard* F2)

If the argument is a wildcard, PWB creates a pseudofile containing a list of files that match the pattern. To open a file from this list, position the cursor at the beginning of the name and execute **Arg Openfile** (ALT+A F10) or **Arg Setfile** (ALT+A F2).

### Meta ... Setfile (F9 ... F2)

As above but does not save the changes to the current file.

### Arg Arg Setfile (ALT+A ALT+A F2)

Saves the current file.

### Arg Arg *textarg* Setfile (ALT+A ALT+A *textarg* F2)

Saves the current file under the name specified by *textarg*.

**Returns**

True	File opened successfully.
False	No alternate file, the specified file does not exist, and you did not wish to create it; or the current file needs to be saved and cannot be saved.

**See** **Newfile**

## Sethelp

**Key**                   SHIFT+CTRL+S

The **Sethelp** function opens and closes single Help files. The **Sethelp** function can also display the current list of open Help files. **Sethelp** affects only the current PWB session.

**Arg Sethelp** (ALT+A SHIFT+CTRL+S)

Opens the Help file specified by the filename at the cursor.

**Arg streamarg | textarg Sethelp** (ALT+A *streamarg* | *textarg* SHIFT+CTRL+S)

Opens the Help file specified by the selected filename.

**Meta ... Sethelp** (F9 ALT+A SHIFT+CTRL+S)

As above except the specified Help file is closed.

**Arg ? Sethelp** (ALT+A ? SHIFT+CTRL+S)

Lists all currently open Help files.

**Returns**           True       Help file opened or closed, or list of Help files displayed.  
False      The specified file could not be opened or closed, or the list of files could not be displayed.

**See**                **Helpfiles**

---

## Setwindow

**Key**                CTRL+]

**Setwindow**

Redisplays the contents of the active window.

**Meta Setwindow** (F9 CTRL+])

Redisplays the current line.

**Arg Setwindow** (ALT+A CTRL+])

Adjusts the window so that the cursor position becomes the home position (upper-left corner).

**Returns**           **Setwindow** always returns true.

## Shell

**Key**                   SHIFT+F9

### Shell

Runs an operating-system command shell. To return to PWB, type `exit` at the operating-system prompt.

---

**Warning** Do not start terminate-and-stay-resident (TSR) programs in a shell. This causes unpredictable results.

---

### Arg Shell (ALT+A SHIFT+F9)

Runs the text from the cursor to the end of the line as a command to the shell, and returns to PWB.

### Arg *boxarg* | *linearg* Shell (ALT+A *boxarg* | *linearg* SHIFT+F9)

Runs each selected line as a separate command to the shell, and returns to PWB.

### Arg *textarg* Shell (ALT+A *textarg* SHIFT+F9)

Runs *textarg* as a command to the shell, and returns to PWB.

### Meta ... Shell (F9 ... SHIFT+F9)

Runs a shell, ignoring the **Autosave** switch. Modified files are not saved to disk, but they are retained in PWB's virtual memory.

**Returns**           True       Shell ran successfully.  
                   False      Invalid argument, or error starting the operating-system command processor.

**See**                   **Askrtm, Restart, Savescreen**

---

## Sinsert

**Key**                   CTRL+J

### Sinsert

Inserts a space at the cursor.

### Arg Sinsert (ALT+A CTRL+J)

Inserts a line break at the cursor, splitting the line.

**Arg** *streamarg* | *linearg* | *boxarg* **Sinsert**  
(ALT+A *streamarg* | *linearg* | *boxarg* CTRL+J)

Inserts a stream of blanks between the starting point of the selection and the cursor. The insertion is always a stream, regardless of the current selection mode.

**Returns** True Spaces or line break inserted.  
False Insertion would make a line too long.

**Example** The following macro inserts a stream of spaces up to the next tab stop, regardless of the current selection mode:

```
InsertTab := Arg Tab Sinsert
```

**See** **Insert, Linsert**

---

## Tab

**Key** TAB

**Tab**  
Moves the cursor to the next tab stop. If there are no tab stops to the right of the cursor, the cursor does not move. Tab stops are defined by the **Tabstops** switch.

**Returns** True Cursor moved.  
False Cursor not moved.

**Update** In PWB 1.x, tab stops appear at fixed intervals. In PWB 2.00, tab stops can be at variable or fixed intervals.

**See** **Backtab**

---

## Tell

**Key** CTRL+T

**Tell**  
Displays the message *Press a key to tell about* and waits for a keystroke. After you press a key or combination of keys, **Tell** brings up the Tell dialog box showing the name of the key and its assigned function in TOOLS.INI key-assignment format.

The key-assignment format is:

*function:key*

If the key is not assigned a function, **Tell** displays *unassigned* for the function name. See: **Unassigned**.

If you press a combination of keys, but **Tell** still shows the *Press a key* prompt (when you press SCROLL LOCK, for example), PWB is unable to recognize that combination of keys and you cannot use it as a key assignment.

**Arg Tell** (ALT+A CTRL+T)

Prompts for a key, then displays the name of the function or macro assigned to the key in one of these formats:

*function:key*

*macroname:=definition*

**Arg textarg Tell** (ALT+A textarg CTRL+T)

Displays the definition of the macro named by *textarg*. If you specify a PWB function, **Tell** displays:

*function:function*

**Meta ... Tell** (F9 ... CTRL+T)

As above except **Tell** types the result into the current file rather than displaying it in a dialog box. This is how to discover the definition of any macro, including PWB macros.

<b>Returns</b>	True      Assignment displayed or typed. False     No assignment for the key or the specified name.
<b>Update</b>	In PWB 1.x, the prompt and results appear on the status bar; in PWB 2.00, the prompt and results appear in dialog boxes.
<b>Remarks</b>	<p><b>Meta Tell</b> is a convenient and reliable way of writing a key assignment when you are configuring PWB.</p> <p>For example, if you want to execute the <b>Curdate</b> function (type today's date) when you press the CTRL, SHIFT, and D keys simultaneously, perform the following steps:</p> <ol style="list-style-type: none"> <li>1. Go to an empty line in the [PWB] section of TOOLS.INI.</li> <li>2. Execute <b>Meta Tell</b> (F9 CTRL+T). <b>Tell</b> displays the message: <i>Press a key to tell about.</i></li> <li>3. Press the D, SHIFT, and CTRL keys simultaneously. If you have not already assigned a function to this combination, <b>Tell</b> types: <i>unassigned:Shift+Ctrl+D</i></li> </ol>

4. Select the word `unassigned` and type `curdate`.
5. If you want the assignment to take effect immediately, move the cursor to the line you've just entered and execute the **Assign** function (ALT+=).

You can use **Meta Arg** *textarg* **Tell** to recover the definition of a predefined PWB macro or a macro that you have not saved or entered into a file.

**See** `_pwbusern`, **Assign**, **Record**

---

## Unassigned

**Keys** Assigned to all available keys.

### Unassigned

Displays a message for keys that do not have a function assignment.

All unassigned keys are actually assigned the **Unassigned** function. Thus, to remove a function assignment for a key, assign the **Unassigned** function to the key. The **Unassigned** function is not useful in macros.

**Returns** The **Unassigned** function always returns false.

**See** **Assign**, **Tell**

---

## Undo

**Keys** ALT+BKSP, SHIFT+CTRL+BKSP

### Undo

Reverses the last editing operation. The maximum number of times this can be performed for each file is set by the **Undocount** switch.

### Meta Undo (F9 ALT+BKSP)

Performs the operation previously reversed with **Undo**. This action is often called "redo."

**Returns** True      Operation undone or redone.  
False      Nothing to undo or redo.

**See** `_pwbundo`, `_pwbredo`, **Repeat**

## Up

**Keys** UP, CTRL+E

### Up

Moves the cursor up one line. If a selection has been started, it is extended by one line. If this movement results in the cursor moving out of the window, the window is adjusted upward as specified by the **Vscroll** switch.

### Meta Up (F9 UP)

Moves the cursor to the top of the window without changing the column position.

**Returns** True Cursor moved.  
False Cursor not moved; the cursor is already at the destination.

**See** **Down**

---

## Usercmd

**Key** Unassigned

The **Usercmd** function executes a custom command added to the Run menu by using Customize command from the Run menu or setting the **User** switch.

### Arg *number* Usercmd (ALT+A *number* Unassigned)

Executes the given custom Run menu command. The *number* can be in the range 1–9.

**Returns** True Command exists.  
False Command does not exist, or invalid argument.

**See** **\_pwbuser*n*, Assign, Record**

# Window

**Key** Unassigned

## Window

Switch to the next window.

Returns	Condition
True	Switched to next window.
False	No next window to switch to: zero or one window open.

## Arg [[Arg]] Window (ALT+A [[ALT+A]] Unassigned)

Open a new window.

Returns	Condition
True	Opened a new window.
False	Window not opened.

## Meta Window (F9 Unassigned)

Close the active window.

Returns	Condition
True	Window closed.
False	No open window to close.

## Meta Arg Window (ALT+A F9 Unassigned)

Switch to the previous window.

Returns	Condition
True	Switched to previous window.
False	No previous window to switch to: zero or one window open.

**Update** In PWB 1.x, **Arg Window** and **Arg Arg Window** split the window at the cursor. In PWB 2.00, these forms of **Window** open a new window.

**See** **Selwindow**, **Setwindow**



## Winstyle

**Key** CTRL+F6

### Winstyle

Advances through the following series of window styles, starting from the current style:

Horizontal Scroll Bar	Vertical Scroll Bar
No	No
No	Yes
Yes	No
Yes	Yes

When the horizontal scroll bar is not shown, a maximized window does not show its bottom border. Similarly, when the vertical scroll bar is not shown, a maximized window does not show its left and right borders. PWB always displays the title bar.

To get the "clean-screen" look, maximize the window and advance the window style until the borders disappear.

**Default** Set the default window style with the **Defwinstyle** switch.

**Returns** True Changed window style.  
False No windows open.

**Update** The no-border state in PWB 1.x is not available in PWB 2.00. In PWB 2.00, when a window is maximized and no scroll bars are present, PWB displays the window without borders.

**See** **Maximize**

## Predefined PWB Macros

PWB predefines a number of macros, most of which correspond to a command in the PWB menus. You can define a shortcut key for a menu command by assigning the key to the corresponding macro. Note that some menu commands such as the Open command from the File menu do not correspond to a macro, and some macros do not correspond to a menu command.

**Table 7.12 PWB Macros**

<b>Macro</b>	<b>Description</b>	<b>Key</b>
Curfile	Current file's full path	Unassigned
Curfileext	Current file's extension	Unassigned
Curfilenam	Current file's name	Unassigned
_pwbarrange	Arrange command, Window menu	ALT+F5
_pwbboxmode	Box Mode command, Edit menu	Unassigned
_pwbbuild	Build command, Project menu	Unassigned
_pwbcancelbuild	Cancel Build command, Project menu	Unassigned
_pwbcancelprint	Cancel Print command, File menu	Unassigned
_pwbcancelsearch	Cancel Search command, Search menu	Unassigned
_pwbcascade	Cascade command, Window menu	F5
_pwbclear	Delete command, Edit menu	DEL
_pwbclose	Close command, Window menu	CTRL+F4
_pwbcloseall	Close All command, Window menu	Unassigned
_pwbclosefile	Close command, File menu	Unassigned
_pwbcloseproject	Close command, Project menu	Unassigned
_pwbcompile	Compile command, Project menu	Unassigned
_pwbfile <i>n</i>	<i>n file</i> , File menu	Unassigned
_pwbgotomatch	Goto Match command, Search menu	Unassigned
_pwbhelp_again	Next command, Help menu	Unassigned
_pwbhelp_back	Previous Help topic	ALT+F1
_pwbhelp_contents	Contents command, Help menu	SHIFT+F1
_pwbhelp_context	Topic command, Help menu	F1
_pwbhelp_general	Help on Help command, Help menu	Unassigned
_pwbhelp_index	Index command, Help menu	Unassigned
_pwbhelpnl	Display the message: Online Help Not Loaded	F1 when Help extension not loaded
_pwbhelp_searchres	Search Results command, Help menu	Unassigned
_pwblinemode	Line Mode command, Edit menu	Unassigned
_pwblogsearch	Log command, Search menu	Unassigned
_pwbmaximize	Maximize command, Window menu	CTRL+F10
_pwbminimize	Minimize command, Window menu	CTRL+F9
_pwbmove	Move command, Window menu	CTRL+F7
_pwbnewfile	New command, File menu	Unassigned

**Table 7.12 PWB Macros** (*continued*)

<b>Macro</b>	<b>Description</b>	<b>Key</b>
_pwbnewwindow	New command, Window menu	Unassigned
_pwbnextfile	Next command, File menu	Unassigned
_pwbnextlogmatch	Next Match command, Search menu	SHIFT+CTRL+F3
_pwbnextmatch	Next Match command, Search menu	Unassigned
_pwbnextmsg	Next Error command, Project menu	SHIFT+F3
_pwbpreviouslogmatch	Previous Match command, Search menu	SHIFT+CTRL+F4
_pwbpreviousmatch	Previous Match command, Search menu	Unassigned
_pwbprevmsg	Previous Error command, Project menu	SHIFT+F4
_pwbprevwindow	Move to previous window	SHIFT+F6
_pwbquit	Exit command, File menu	ALT+F4
_pwbrebuild	Rebuild All command, Project menu	Unassigned
_pwbrecord	Record command, Edit menu	Unassigned
_pwbredo	Redo command, Edit menu	Unassigned
_pwbrepeat	Repeat command, Edit menu	Unassigned
_pwbresize	Resize command, Window menu	CTRL+F8
_pwbrestore	Restore command, Window menu	CTRL+F5
_pwbsaveall	Save All command, File menu	Unassigned
_pwbsavefile	Save command, File menu	SHIFT+F2
_pwbsetmsg	Goto Error command, Project menu	Unassigned
_pwbshell	DOS Shell command, File menu	Unassigned
_pwbstreammode	Stream Mode command, Edit menu	Unassigned
_pwbtile	Tile command, Window menu	SHIFT+F5
_pwbundo	Undo command, Edit menu	Unassigned
_pwbuser <i>n</i>	<i>command n</i> , Run menu	ALT+F <i>n</i>
_pwbviewbuildresults	View build results button	Unassigned
_pwbviewsearchresults	View search results button	Unassigned
_pwbwindow <i>n</i>	<i>n file</i> , Window menu	ALT+ <i>n</i>

PWB continually redefines the following macros to reflect the current file's name:

<b>Macro</b>	<b>Description</b>
<b>Curfile</b>	Full path
<b>Curfileext</b>	File extension
<b>Curfilenam</b>	File base name

PWB uses the following special-purpose macros:

Macro	Description
<b>Autostart</b>	Executed on startup while reading TOOLS.INI
<b>Mgrep</b>	List of files for logged searches, multifile replace, <b>Mgrep</b> , and <b>Mreplace</b>
<b>Playback</b>	Default name of recorded macros
<b>Restart</b>	(Obsolete)

By default, these macros are undefined.

---

## Autostart

**Key** Unassigned

The special PWB macro **Autostart** is executed after PWB finishes all initialization at startup. If used, it must be defined in the [PWB] section of TOOLS.INI.

**Definition** By default, **Autostart** is not defined.

---

## Curfile

**Key** Unassigned

The **Curfile** macro types the full path of the current file. This macro is redefined each time you switch to a new file.

**Definition** `curfile := "pathname"`

**Example** The following macro copies the full path of the current file to the clipboard for later use:

```
Path2clip := Arg Curfile Copy
```

**See** **Arg, Copy, Curdate, Curday, Curfilenam, Curfileext, Curtime**

---

## Curfileext

<b>Key</b>	Unassigned
	The <b>Curfileext</b> macro types the filename extension of the current file. This macro is redefined each time you switch to a new file.
<b>Definition</b>	<code>curfileext := "extension"</code>
<b>Example</b>	The following macro copies the base name plus the extension of the current file to the clipboard for later use:  <code>Filename2clip := Arg Curfilenam Curfileext Copy</code>
<b>See</b>	<b>Arg, Copy, Curdate, Curday, Curfile, Curfilenam, Curtime</b>

---

## Curfilenam

<b>Key</b>	Unassigned
	The <b>Curfilenam</b> macro types the base name of the current file. This macro is redefined each time you switch to a new file.
<b>Definition</b>	<code>curfilenam := "basename"</code>
<b>Example</b>	The following macro copies the base name of the current file to the clipboard for later use:  <code>Name2clip := Arg Curfilenam Copy</code>
<b>See</b>	<b>Arg, Copy, Curdate, Curday, Curfile, Curfileext, Curtime</b>

---

## Mgreplist

<b>Key</b>	Unassigned
	The special PWB macro <b>Mgreplist</b> is used by the Find and Replace commands on the Search menu, <b>Mgrep</b> , <b>Mreplace</b> , and <b>Mreplaceall</b> to specify the list of files to search.

When you create a list of files to search using the Files button in either the Find or Replace dialog box, PWB redefines the **Mgreplist** macro with the specified list of files.

To see the current list of files, choose the Files button in the Replace dialog box. You can change the list in this dialog box, and either choose OK to perform the find-and-replace operation, or choose Cancel to cancel the replace and accept the changes to **Mgreplist**.

You can also insert the definition of **Mgreplist** into the current file by using the phrase: **Arg Meta Mgreplist Tell** (ALT+A F9 Mgreplist CTRL+T).

You can edit the macro, then redefine it by using the **Assign** function (ALT+=).

**Definition** Mgreplist:= "*list*"

*list*

Space-separated list of filenames

The filenames can use the operating-system wildcards (\* and ?), and can use environment-variable specifiers. Note that backslashes (\) must be doubled in the macro string.

**See** **Assign, Tell, Mgrep, Mreplace, Mreplaceall**

---

## Restart

**Key** Unassigned

**Update** In PWB 1.x, the special PWB macro Restart is executed whenever PWB returns from a shell, build, or other external operation.

In PWB 2.00, the **Restart** macro is never executed automatically and has no special meaning; it is an ordinary macro.

---

## **\_pwbarrange**

**Key** ALT+F5

**Menu** Window menu, Arrange command

The **\_pwbarrange** macro arranges all unminimized windows on the desktop. The following illustration shows a typical desktop after execution of **\_pwbarrange**:

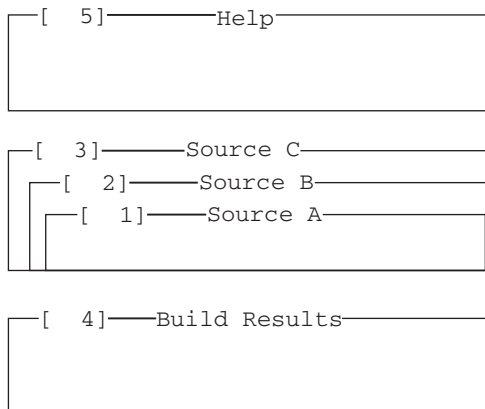

**Figure 7.1 Arranged Windows**

**Definition**

`_pwbarrange:=cancel arg arrangewindow <`

**Cancel**

Establishes a uniform “ground state” by canceling any selection or argument.

**Arg Arrangewindow**

Arranges all unminimized windows on the desktop.

`<`

Restores the function’s prompt (if any). By default, function prompts are suppressed while a macro is running.

**See**

**Arrangewindow**

## **`_pwbboxmode`**

**Key**

Unassigned

**Menu**

Edit menu, Box Mode command

The **`_pwbboxmode`** macro sets the selection mode to box selection mode.

**Definition**

`_pwbboxmode := :>more selmode ->more selmode`

**`:>more`**

Defines the label `more`.

**Selmode**

Advances to the next selection mode.

**->more**

Branches to the label `more` if **Selmode** returns false.

The **Selmode** function advances the selection mode from box, to stream, to line. **Selmode** returns true when the mode is stream mode. The macro executes the **Selmode** function until it returns true (sets stream mode), then advances the selection mode once to set box selection mode.

**See** Enterselmode, Selmode

---

## **\_pwbuild**

**Key** Unassigned

**Menu** Project menu, Build command

The **\_pwbuild** macro builds the “all” target of the current PWB project. The “all” pseudotarget in a PWB project lists all the targets in the project.

For non-PWB projects, **\_pwbuild** builds the targets that were last specified by using the Build Target command from the Project menu. PWB redefines **\_pwbuild** each time you use Build Target. If no target has been specified, NMAKE builds the first target listed in the project makefile.

**Definition** `_pwbuild := cancel arg "all" compile <`

**Cancel**

Establishes a uniform “ground state” by cancelling any selection or argument.

**Arg “all” Compile**

Builds the `all` pseudotarget in the current project.

`<`

Restores the function’s prompt (if any). By default, function prompts are suppressed while a macro is running.

**See** Arg, Cancel, Compile

---

## **\_pwbcancelbuild**

**Key** Unassigned

**Menu** Project menu, Cancel Build command



The **\_pwbcancelbuild** macro terminates the current background build or compile and flushes any queued build operations.

**Definition**            `_pwbcancelbuild := cancel arg meta compile`

**Cancel**

Establishes a uniform “ground state” by canceling any selection or argument.

**Arg Meta Compile**

Terminates the background build process.

**See**                   **Arg, Cancel, Compile, Meta**

---

## **\_pwbcancelprint**

**Key**                   Unassigned

The **\_pwbcancelprint** macro terminates all background print operations.

**Definition**           `_pwbcancelprint := cancel arg meta print`

**Cancel**

Establishes a uniform “ground state” by canceling any selection or argument.

**Arg Meta Print**

Terminate background print operations.

**See**                   **Arg, Cancel, Meta, Print**

---

## **\_pwbcancelsearch**

**Key**                   Unassigned

**Menu**                  Search menu, Cancel Search command

The **\_pwbcancelsearch** macro cancels the current background search. PWB performs logged searches in the background under multithreaded environments.

**Definition**           `_pwbcancelsearch := cancel cancelsearch <`

**Cancel**

Establishes a uniform “ground state” by canceling any selection or argument.

**Cancelsearch**

Cancels the current background search.

<

Restores the function's prompt (if any). By default, function prompts are suppressed while a macro is running.

**See** Cancel, Cancelsearch, Logsearch

---

## **\_pwbcascade**

**Key** F5

**Menu** Window menu, Cascade command

The **\_pwbcascade** macro arranges all unminimized windows in cascaded fashion so that all of their titles are visible. Up to 16 unminimized windows can be cascaded.

**Definition** \_pwbcascade := cancel arrangewindow <

**Cancel**

Establishes a uniform "ground state" by canceling any selection or argument.

**Arrangewindow**

Cascades all unminimized windows.

<

Restores the function's prompt (if any). By default, function prompts are suppressed while a macro is running.

**See** Arrangewindow, Cancel

---

## **\_pwbclear**

**Key** DEL

**Menu** Edit menu, Delete command

The **\_pwbclear** macro removes the selected text from the file. If there is no selection, PWB removes the current line.

The selection or line is not copied to the clipboard. It can be recovered only by using the Undo command from the Edit menu or **Undo** (ALT+BKSP).

**Definition**      `_pwbclear := meta delete`

**Meta Delete**

Removes the selection or the current line from the file without modifying the clipboard.

**See**                **Delete, Meta**

---

## **`_pwbcloseall`**

**Key**                Unassigned

**Menu**              Window menu, Close All command

The **`_pwbcloseall`** macro closes all open windows.

**Definition**      `_pwbcloseall := cancel arg arg meta window <`

**Cancel**

Establishes a uniform “ground state” by canceling any selection or argument.

**Arg Arg Meta Window**

Closes all windows.

<

Restores the function’s prompt (if any). By default, function prompts are suppressed while a macro is running.

**See**                **Arg, Cancel, Meta, Window**

---

## **`_pwbclosefile`**

**Key**                Unassigned

**Menu**              File menu, Close command

The **`_pwbclosefile`** macro closes the current file. If no files remain in the window’s file history, the window is closed.

**Definition**      `_pwbclosefile := cancel closefile <`

**Cancel**

Establishes a uniform “ground state” by canceling any selection or argument.

**Closefile**

Closes the current file.

<

Restores the function's prompt (if any). By default, function prompts are suppressed while a macro is running.

**See** Cancel, Closefile

---

## **\_pwbcloseproject**

**Key** Unassigned

**Menu** Project menu, Close Project command

The **\_pwbcloseproject** macro closes the current project.

**Definition** `_pwbcloseproject := cancel arg arg project <`

**Cancel**

Establishes a uniform "ground state" by canceling any selection or argument.

**Arg Arg Project**

Closes the current project.

<

Restores the function's prompt (if any). By default, function prompts are suppressed within a macro.

**See** Arg, Cancel, Project

---

## **\_pwbcompile**

**Key** Unassigned

**Menu** Project menu, Compile File command

The **\_pwbcompile** macro compiles the current file.

**Definition** `_pwbcompile := cancel arg compile <`

**Cancel**

Establishes a uniform "ground state" by canceling any selection or argument.

**Arg Compile**

Compiles the current file.

&lt;

Restores the function's prompt (if any). By default, function prompts are suppressed while a macro is running.

**See**            **Arg, Cancel, Compile**

---

## **\_pwbgotomatch**

**Key**            Unassigned

**Menu**           Search menu, Goto Match command

The **\_pwbgotomatch** macro sets the match listed at the current location in the Search Results pseudofile as the current match and moves the cursor to the location specified by that match.

**Definition**    `_pwbgotomatch := cancel arg arg nextsearch <`

**Cancel**

Establishes a uniform "ground state" by canceling any selection or argument.

**Arg Arg Nextsearch**

Goes to the current match.

&lt;

Restores the function's prompt (if any). By default, function prompts are suppressed while a macro is running.

**See**            **Arg, Cancel, Nextsearch**

---

## **\_pwbhelpnl**

The **\_pwbhelpnl** macro displays a message indicating the Help extension is not loaded. The Help keys are assigned this macro until the Help extension is loaded.

**Definition**    `_pwbhelpnl := cancel arg "OnLine Help Not Loaded" message`

**Cancel**

Establishes a uniform "ground state" by canceling any selection or argument.

**Arg “OnLine Help Not Loaded” Message**

Displays the message on the status bar.

**See**

**Arg, Cancel, Load, Message**

**\_pwbhelp\_again****Key**

Unassigned

**Menu**

Help menu, Next command

The **\_pwbhelp\_again** displays the next occurrence of the last topic for which you requested Help. If no other occurrences of the topic are defined in the open files, PWB redisplay the current topic.

The topic that PWB looks up when you use this command is displayed after the Next command on the Help menu, as follows:

**Next:** *topic key*

*topic* Topic string used for the command.

*key* Current key assignment for **\_pwbhelp\_again** (if any).

**Definition**

**\_pwbhelp\_again:=cancel arg pwbhelp.pwbhelpnext <**

**Cancel**

Establishes a uniform “ground state” by canceling any selection or argument.

**Arg**

Sets the **Arg** prefix for the **Pwbhelpnext** function.

**Pwbhelp.**

Specifies that the function is the PWBHELP extension function.

**Pwbhelpnext**

Displays the next occurrence of the previously requested topic.

<

Restores the function’s prompt (if any). By default, function prompts are suppressed while a macro is running.

**See**

**Pwbhelpnext**

## **`_pwbhelp_back`**

<b>Key</b>	ALT+F1
	The <b><code>_pwbhelp_back</code></b> macro displays the previously viewed Help topic. Up to 20 topics are kept in the Help backtrace list.
<b>Definition</b>	<code>_pwbhelp_back:=cancel meta pwbhelp.pwbhelpnext &lt;</code>
	<b>Cancel</b> Establishes a uniform “ground state” by canceling any selection or argument.
	<b>Meta</b> Sets the meta prefix for the function.
	<b>Pwbhelp.</b> Specifies that the function is the PWBHELP extension function.
	<b>Pwbhelpnext</b> Displays the previously viewed Help topic.
	<b>&lt;</b> Restores the function’s prompt (if any). By default, function prompts are suppressed while a macro is running.
<b>See</b>	<b>Pwbhelpnext</b>

---

## **`_pwbhelp_contents`**

<b>Key</b>	SHIFT+F1
<b>Menu</b>	Help menu, Contents command
	The <b><code>_pwbhelp_contents</code></b> macro opens the Help window and displays the top-level contents of the Help system.
	Within the Help system, most Help topics have a Contents button at the top of the window. This button also takes you to the top-level contents.
<b>Definition</b>	<code>_pwbhelp_contents:=cancel arg "advisor.hlp!h.contents" pwbhelp.pwbhelp &lt;</code>
	<b>Cancel</b> Establishes a uniform “ground state” by canceling any selection or argument.
	<b>Arg "advisor.hlp!h.contents"</b> Defines a text argument with the topic name for the general table of contents.

**Pwbhelp.**

Specifies that the function is the PWBHELP extension function.

**Pwbhelp**

Looks up the topic `h.contents` in the ADVISOR.HLP Help file.

&lt;

Restores the function's prompt (if any). By default, function prompts are suppressed while a macro is running.

**See****Pwbhelp**

---

## **`_pwbhelp_context`**

**Key**

F1

**Menu**

Help menu, Topic command

The **`_pwbhelp_context`** macro looks up Help on the topic at the cursor, the current selection, or the specified text argument.

**Definition**`_pwbhelp_context:=arg pwbhelp.pwbhelp <`**Arg**

Sets the Arg prefix for the **Pwbhelp** function.

**Pwbhelp.**

Specifies that the function is the PWBHELP extension function.

**Pwbhelp**

Displays Help on the topic at the cursor. When text is selected, displays Help on the selected text. When you have entered an argument in the Text Argument dialog box, displays Help on the topic specified by the text argument.

&lt;

Restores the function's prompt (if any). By default, function prompts are suppressed while a macro is running.

**See****Pwbhelp**



---

## **\_pwbhelp\_general**

<b>Key</b>	Unassigned
<b>Menu</b>	Help menu, Help on Help command  The <b>_pwbhelp_general</b> macro opens the Help window and displays information about using the Help system.
<b>Definition</b>	<code>_pwbhelp_general:=cancel arg "advisor.hlp!h.default" pwbhelp.pwbhelp &lt;</code> <b>Cancel</b> Establishes a uniform “ground state” by canceling any selection or argument. <b>Arg</b> "advisor.hlp!h.default" Defines a text argument with the topic name for default Help. <b>Pwbhelp.</b> Specifies that the function is the PWBHELP extension function. <b>Pwbhelp</b> Looks up the topic “h.default” in the ADVISOR.HLP Help file. < Restores the function’s prompt (if any). By default, function prompts are suppressed while a macro is running.
<b>See</b>	<b>Pwbhelp</b>

---

## **\_pwbhelp\_index**

<b>Key</b>	Unassigned
<b>Menu</b>	Help menu, Index command  The <b>_pwbhelp_index</b> macro opens the Help window and displays the top-level table of indexes in the Help system.  Within the Help system, most Help topics have an Index button at the top of the window. This button also takes you to the top-level table of indexes.
<b>Definition</b>	<code>_pwbhelp_index:=cancel arg "advisor.hlp!h.index" pwbhelp.pwbhelp &lt;</code> <b>Cancel</b> Establishes a uniform “ground state” by canceling any selection or argument. <b>Arg</b> "advisor.hlp!h.index" Defines a text argument with the topic name for the Help index.

**Pwbhelp.**

Specifies that the function is the PWBHELP extension function.

**Pwbhelp**

Looks up the topic “h.index” in the ADVISOR.HLP Help file.

&lt;

Restores the function’s prompt (if any). By default, function prompts are suppressed while a macro is running.

**See**                    **Pwbhelp**

---

## **\_pwbhelp\_searchres**

**Key**                    Unassigned

**Menu**                    Help menu, Search Results command

The **\_pwbhelp\_searchres** macro opens the Help window and displays the list of matches found during the last global Help search.

**Definition**            `_pwbhelp_searchres:=cancel pwbhelp.pwbhelpsearch <`

**Cancel**

Establishes a uniform “ground state” by canceling any selection or argument.

**Pwbhelp.**

Specifies that the function is the PWBHELP extension function.

**Pwbhelpsearch**

Opens the Help window and displays the results of the last global Help search.

&lt;

Restores the function’s prompt (if any). By default, function prompts are suppressed while a macro is running.

**See**                    **Pwbhelpsearch**

---

## **\_pwblinemode**

**Key**                    Unassigned

**Menu**                    Edit menu, Line Mode command

The **\_pwblinemode** macro sets the selection mode to line selection mode.

**Definition**      `_pwblinemode := :>more selmode ->more selmode selmode`

`:>more`  
 Defines the label `more`.

**Selmode**

Advances to the next selection mode.

`->more`  
 Branches to the label `more` if **Selmode** returns false.

The **Selmode** function advances the selection mode from `box`, to `stream`, to `line`. **Selmode** returns true when the mode is stream mode. The macro executes the **Selmode** function until it returns true (sets stream mode), then advances the selection mode twice to set line selection mode.

**See**                **Enterselmode, Selmode**

## **`_pwblogsearch`**

**Key**                Unassigned

**Menu**              Search menu, Log command

The **`_pwblogsearch`** macro toggles search logging on and off.

When search logging is turned on, PWB displays a bullet next to the Log command on the Search menu. The Next Match command executes the **`_pwbnextlogmatch`** macro, and the Previous Match command executes the **`_pwbpreviouslogmatch`** macro. When search logging is turned off, no bullet appears and the Next Match and Previous Match commands execute **`_pwbnextmatch`** and **`_pwbpreviousmatch`**.

**Definition**      `_pwblogsearch := cancel logsearch <`

**Cancel**

Establishes a uniform “ground state” by canceling any selection or argument.

**Logsearch**

Toggles the logging of search results on and off.

`<`

Restores the function’s prompt (if any). By default, function prompts are suppressed while a macro is running.

**See**                **Cancel, Logsearch**

## **\_pwbmaximize**

**Key** CTRL+F10

**Menu** Window menu, Maximize command

The **\_pwbmaximize** macro enlarges the active window to its largest possible size, showing only the window, the menu bar, and the status bar on the PWB screen.

**Definition** `_pwbmaximize := cancel maximize <`

**Cancel**

Establishes a uniform “ground state” by canceling any selection or argument.

**Maximize**

Enlarges the active window to full size.

<

Restores the function’s prompt (if any). By default, function prompts are suppressed while a macro is running.

**See** **Cancel, Minimize**

---

## **\_pwbminimize**

**Key** CTRL+F9

**Menu** Window menu, Minimize command

The **\_pwbminimize** macro minimizes the active window, reducing the window to an icon. To restore a window to its original size, double-click in the box or use the Restore command (CTRL+F5) on the Window menu.

**Definition** `_pwbminimize := cancel minimize <`

**Cancel**

Establishes a uniform “ground state” by canceling any selection or argument.

**Minimize**

Shrinks the window to an icon.

<

Restores the function’s prompt (if any). By default, function prompts are suppressed while a macro is running.

**See** **Cancel, Maximize, Minimize**

## **\_pwbmove**

**Key** CTRL+F7

**Menu** Window menu, Move command

The **\_pwbmove** macro starts window-moving mode for the active window. In window-moving mode, you can only do the following:

<b>Action</b>	<b>Key</b>
Move up one row	UP
Move down one row	DOWN
Move left one column	LEFT
Move right one column	RIGHT
Accept the new position	ENTER
Cancel the move	ESC

To move the window in larger increments, you can use a numeric argument with the **Movewindow** function.

**Definition** `_pwbmove := cancel movewindow <`

### **Cancel**

Establishes a uniform “ground state” by canceling any selection or argument.

### **Movewindow**

Starts window-moving mode.

<

Restores the function's prompt (if any). By default, function prompts are suppressed while a macro is running.

**See** **Arrangewindow, Cancel, Maximize, Minimize, Resize**

## **\_pwbnewfile**

**Key** Unassigned

**Menu** File menu, New command

The **\_pwbnewfile** macro creates a new pseudofile.

New pseudofiles are given a unique name of the form:

<Untitled.*nnn*>Untitled.*nnn*

where <*nnn*> is a three-digit number starting with 001 at the beginning of each PWB session. The window title shows Untitled.*nnn*. The file may be referred to by the name <Untitled.*nnn*>.

When the **Newwindow** switch is set to yes, or the active window is a PWB window, a new window is opened for the file. Otherwise, the file is opened in the active window, and the previous file is placed in the window's file history.

#### Definition

`_pwbnewfile := cancel newfile <`

#### Cancel

Establishes a uniform "ground state" by canceling any selection or argument.

#### Newfile

Creates a new untitled pseudofile.

<

Restores the function's prompt (if any). By default, function prompts are suppressed while a macro is running.

#### See

**Cancel, Setfile**

## **`_pwbnewwindow`**

#### Key

Unassigned

#### Menu

Window menu, New command

The **`_pwbnewwindow`** macro opens a new window, which shows the current file. The new window has the complete file history as the original window.

#### Definition

`_pwbnewwindow := cancel arg window`

#### Cancel

Establishes a uniform "ground state" by canceling any selection or argument.

#### Arg Window

Opens a new window on the current file

#### See

**Arg, Cancel, Window**

---

## **\_pwbnextfile**

**Key** Unassigned

**Menu** File menu, Next command

The **\_pwbnextfile** macro moves to the next file in the list of files specified on the PWB command line. If no more files remain in the list, this macro ends the PWB session.

When the **Newwindow** switch is set to yes, or the active window is a PWB window, a new window is opened for the file. Otherwise, the file is opened in the active window, and the previous file is placed in the window's file history.

**Definition** `_pwbnextfile := cancel exit <`

**Cancel**

Establishes a uniform "ground state" by canceling any selection or argument.

**Exit**

Moves to the next file specified on the command line.

<

Restores the function's prompt (if any). By default, function prompts are suppressed while a macro is running.

**See** **Exit, Askexit, Cancel, PWB Command Line**

---

## **\_pwbnextlogmatch**

**Key** SHIFT+CTRL+F3

**Menu** Search menu, Next Match command

The **\_pwbnextlogmatch** macro advances the cursor to the next match listed in the Search Results pseudofile.

The Next Match command on the Search menu executes this macro when search logging is turned on. When search logging is turned off, Next Match executes the **\_pwbnextmatch** macro.

**Definition** `_pwbnextlogmatch := cancel nextsearch <`

**Cancel**

Establishes a uniform "ground state" by canceling any selection or argument.

**Nextsearch**

Advances to the next match in Search Results.

&lt;

Restores the function's prompt (if any). By default, function prompts are suppressed while a macro is running.

**See**                    **Cancel, Nextsearch**

---

## **\_pwbnextmatch**

**Key**                    Unassigned

**Menu**                   Search menu, Next Match command

The **\_pwbnextmatch** macro searches forward in the file using the last search pattern and options. The search options are Match Case, Wrap Around, and Regular Expression.

The Next Match command on the Search menu executes this macro when search logging is turned off. When search logging is turned on, Next Match executes the **\_pwbnextlogmatch** macro.

**Definition**            `_pwbnextmatch := cancel psearch <`

**Cancel**

Establishes a uniform "ground state" by canceling any selection or argument.

**Psearch**

Searches forward in the file for the next occurrence of the last search string or pattern.

&lt;

Restores the function's prompt (if any). By default, function prompts are suppressed while a macro is running.

**See**                    **Cancel, Psearch**

---

## **\_pwbnextmsg**

**Key**                    SHIFT+F3

**Menu**                   Project menu, Next Error command



	The <b>_pwbnextmsg</b> macro moves the cursor to the next message in Build Results.
<b>Definition</b>	<code>_pwbnextmsg := cancel nextmsg &lt;</code>
	<b>Cancel</b> Establishes a uniform “ground state” by canceling any selection or argument.
	<b>Nextmsg</b> Goes to the next message in Build Results.
	<b>&lt;</b> Restores the function’s prompt (if any). By default, function prompts are suppressed while a macro is running.
<b>See</b>	<b>Cancel, Nextmsg</b>

---

## **\_pwbpreviouslogmatch**

<b>Key</b>	SHIFT+CTRL+F4
<b>Menu</b>	Search menu, Previous Match command
	The <b>_pwbpreviouslogmatch</b> macro moves the cursor to the previous match listed in the Search Results pseudofile.
	The Previous Match command on the Search menu executes this macro when search logging is turned on. When search logging is turned off, Previous Match executes the <b>_pwbpreviousmatch</b> macro.
<b>Definition</b>	<code>_pwbpreviouslogmatch := cancel arg "-1" nextsearch &lt;</code>
	<b>Cancel</b> Establishes a uniform “ground state” by canceling any selection or argument.
	<b>Arg "-1" Nextsearch</b> Moves to the previous match listed in Search Results.
	<b>&lt;</b> Restores the function’s prompt (if any). By default, function prompts are suppressed while a macro is running.
<b>See</b>	<b>Arg, Cancel, Nextsearch</b>

## **\_pwbpreviousmatch**

**Key** Unassigned

**Menu** Search menu, Previous Match command

The **\_pwbpreviousmatch** macro searches backward in the file, using the last search pattern and options. The search options are Match Case, Wrap Around, and Regular Expression.

The Previous Match command on the Search menu executes this macro when search logging is turned off. When search logging is turned on, Previous Match executes the **\_pwbpreviouslogmatch** macro.

**Definition** `_pwbpreviousmatch := cancel msearch <`

**Cancel**

Establishes a uniform “ground state” by canceling any selection or argument.

**Msearch**

Searches backward in the file for the last search string or pattern.

<

Restores the function’s prompt (if any). By default, function prompts are suppressed while a macro is running.

**See** **Cancel, Msearch**

---

## **\_pwbprevmsg**

**Key** SHIFT+F4

**Menu** Project menu, Previous Error command

The **\_pwbprevmsg** macro moves the cursor to the previous message in the Build Results pseudofile.

**Definition** `_pwbprevmsg := cancel arg "-1" nextmsg <`

**Cancel**

Establishes a uniform “ground state” by canceling any selection or argument.

**Arg "-1" Nextmsg**

Goes to the previous message in Build Results.

<  
Restores the function's prompt (if any). By default, function prompts are suppressed while a macro is running.

**See**            **Arg, Cancel, Nextmsg**

---

## **\_pwbprevwindow**

**Key**            SHIFT+F6

The **\_pwbprevwindow** macro moves the focus to the previous window. That is, PWB sets the previously active window as the active window. This action moves among the open windows in the reverse order of **Selwindow** (F6).

**Definition**    `_pwbprevwindow:=cancel meta selwindow <`

### **Cancel**

Establishes a uniform "ground state" by canceling any selection or argument.

### **Meta Selwindow**

Moves the focus to the previous window.

<  
Restores the function's prompt (if any). By default, function prompts are suppressed while a macro is running.

**See**            **Cancel, Meta, Selwindow**

---

## **\_pwbquit**

**Key**            ALT+F4

**Menu**           File menu, Exit command

The **\_pwbquit** macro leaves PWB immediately. Any specified files on the PWB command line that have not been opened are ignored.

**Definition**    `_pwbquit := cancel arg exit <`

### **Cancel**

Establishes a uniform "ground state" by canceling any selection or argument.

### **Arg Exit**

Leaves PWB.

<  
Restores the function's prompt (if any). By default, function prompts are suppressed while a macro is running.

**See** Arg, Askexit, Cancel, Exit, Savescreen

---

## **\_pwbrebuild**

**Key** Unassigned

**Menu** Project menu, Rebuild All command

The **\_pwbrebuild** macro forces a rebuild of everything in the current project.

For non-PWB projects, **\_pwbrebuild** rebuilds the targets that were last specified by using the Build Target command on the Project menu. PWB redefines **\_pwbrebuild** each time you use Build Target. If no target has been specified, NMAKE rebuilds the first target listed in the project makefile.

**Definition** `_pwbrebuild := cancel arg meta "all" compile <`

### **Cancel**

Establishes a uniform "ground state" by canceling any selection or argument.

### **Arg Meta "all" Compile**

Rebuilds the `all` pseudotarget.

<  
Restores the function's prompt (if any). By default, function prompts are suppressed while a macro is running.

**See** Arg, Cancel, Compile, Meta

---

## **\_pwbrecord**

**Key** Unassigned

**Menu** Edit menu, Record On command

The **\_pwbrecord** macro toggles macro recording on and off. If you have not set the recorded macro name and key, PWB displays the Set Macro Record dialog box so you can set them. Execute **\_pwbrecord** again to start recording.

**Definition**      `_pwbrecord := cancel record <`

**Cancel**

Establishes a uniform “ground state” by canceling any selection or argument.

**Record**

Toggles macro recording on and off.

`<`

Restores the function’s prompt (if any). By default, function prompts are suppressed while a macro is running.

**See**                **Cancel, Record**

---

## **`_pwbredo`**

**Key**                Unassigned

**Menu**              Edit menu, Redo command

The **`_pwbredo`** macro restores the last modification that was reversed using Edit Undo or **Undo** (ALT+BKSP).

**Definition**      `_pwbredo := cancel meta undo <`

**Cancel**

Establishes a uniform “ground state” by canceling any selection or argument.

**Meta Undo**

Restores the last “undone” modification.

`<`

Restores the function’s prompt (if any). By default, function prompts are suppressed while a macro is running.

**See**                **Cancel, Meta, Undo**

---

## **`_pwbrepeat`**

**Key**                Unassigned

**Menu**              Edit menu, Repeat command

The **`_pwbrepeat`** macro repeats the last editing operation once.

**Definition**      `_pwbrepeat := cancel repeat <`

**Cancel**

Establishes a uniform “ground state” by canceling any selection or argument.

**Repeat**

Repeats the last operation one time.

<

Restores the function’s prompt (if any). By default, function prompts are suppressed while a macro is running.

**See**                **Cancel, Repeat**

---

## **`_pwbresize`**

**Key**                CTRL+F8

**Menu**              Window menu, Size command

The **`_pwbresize`** macro starts window-sizing mode for the active window. When in window-resizing mode, only the following actions are available:

<b>Action</b>	<b>Key</b>
Shrink one row	UP
Expand one row	DOWN
Shrink one column	LEFT
Expand one column	RIGHT
Accept the new size	ENTER
Cancel the resize	ESC

To size the window in larger increments, you can use the numeric forms of the **Resize** function.

**Definition**      `_pwbresize := cancel resize <`

**Cancel**

Establishes a uniform “ground state” by canceling any selection or argument.

**Resize**

Starts window-sizing mode.

<  
Restores the function's prompt (if any). By default, function prompts are suppressed while a macro is running.

**See**                    **Arrangewindow, Cancel, Maximize, Minimize, Movewindow**

---

## **\_pwbrestore**

**Key**                    CTRL+F5

**Menu**                    Window menu, Restore command

The **\_pwbrestore** macro restores the active window to its size before it was maximized or minimized.

**Definition**            **\_pwbrestore := cancel meta maximize**

### **Cancel**

Establishes a uniform "ground state" by canceling any selection or argument.

### **Meta Maximize**

Restores the window to its previous size.

**See**                    **Cancel, Maximize, Meta, Minimize**

---

## **\_pwbsaveall**

**Key**                    Unassigned

**Menu**                    File menu, Save All command

The **\_pwbsaveall** macro saves all modified disk files. Modified pseudofiles are not saved.

**Definition**            **\_pwbsaveall := cancel saveall <**

### **Cancel**

Establishes a uniform "ground state" by canceling any selection or argument.

### **Saveall**

Writes all modified files to disk.

&lt;

Restores the function's prompt (if any). By default, function prompts are suppressed while a macro is running.

**See**                    **Cancel, Saveall**

---

## **\_pwbsavefile**

**Key**                    SHIFT+F2

**Menu**                  File menu, Save command

The **\_pwbsavefile** macro saves the current file to disk.

If the current file is a pseudofile (an untitled file), PWB displays the Save As dialog box so you can give the file a more meaningful name.

**Definition**            **\_pwbsavefile := cancel arg arg setfile <**

### **Cancel**

Establishes a uniform "ground state" by canceling any selection or argument.

### **Arg Arg Setfile**

Writes the current file to disk.

&lt;

Restores the function's prompt (if any). By default, function prompts are suppressed when a macro is running.

**See**                    **Arg, Cancel, Setfile**

---

## **\_pwbsetmsg**

**Key**                    Unassigned

**Menu**                  Project menu, Goto Error command

The **\_pwbsetmsg** macro sets the message listed at the current location in the Build Results pseudofile as the current message and moves the cursor to the location specified by that message.

**See**                    **Nextmsg**

**Definition**            **\_pwbsetmsg := cancel arg arg nextmsg <**



**Cancel**

Establishes a uniform "ground state" by canceling any selection or argument.

**Arg Arg Nextmsg**

Goes to the current message.

&lt;

Restores the function's prompt (if any). By default, function prompts are suppressed while a macro is running.

**See**           **Arg, Cancel, Nextmsg**

---

## **\_pwshell**

**Key**           Unassigned

**Menu**          File menu, DOS Shell command

The **\_pwshell** macro temporarily leaves PWB, starting a new operating-system shell. To return to PWB, type `exit` at the operating-system prompt.

**Definition**    `_pwshell := cancel shell <`

**Cancel**

Establishes a uniform "ground state" by canceling any selection or argument.

**Shell**

Starts an operating-system shell.

&lt;

Restores the function's prompt (if any). By default, function prompts are suppressed while a macro is running.

**See**           **Asktrn, Cancel, Savescreen, Shell**

---

## **\_pwstreammode**

**Key**           Unassigned

**Menu**          Edit menu, Stream Mode command

The **\_pwstreammode** macro sets the selection mode to stream selection mode.

**Definition**    `_pwstreammode := :>more selmode ->more`

:>more  
Defines the label `more`.

**Selmode**  
Advances to the next selection mode.

->more  
Branches to the label `more` if **Selmode** returns false.

The **Selmode** function advances the selection mode from box, to stream, to line. **Selmode** returns true when the mode is stream mode. The macro executes **Selmode** until it returns true (sets stream selection mode).

See **Enterselmode, Selmode**

---

## **\_pwbtile**

**Key**                   SHIFT+F5

**Menu**                   Window menu, Tile command

The **\_pwbtile** macro tiles all unminimized windows on the desktop so that no windows overlap and the desktop is completely covered. Up to 16 unminimized windows can be tiled.

**Definition**            `_pwbtile := cancel meta arrangewindow <`

**Cancel**  
Establishes a uniform “ground state” by canceling any selection or argument.

**Meta Arrangewindow**  
Tiles all unminimized windows.

<  
Restores the function’s prompt (if any). By default, function prompts are suppressed while a macro is running.

See **Arrangewindow, Cancel, Meta**

---

## **\_pwbundo**

**Key**                    Unassigned

**Menu**                   Edit menu, Undo command

The **\_pwbundo** macro reverses the last modification made to the current file. The maximum number of modifications that can be undone for each file is determined by the **Undocount** switch.

**Definition**

`_pwbundo := cancel undo <`

**Cancel**

Establishes a uniform "ground state" by canceling any selection or argument.

**Undo**

Reverses the last modification.

<

Restores the function's prompt (if any). By default, function prompts are suppressed while a macro is running.

**See**

**Cancel, \_pwbredo**

---

## **\_pwbusern**

Macro	Description	Key
<b>_pwbuser1</b>	Run custom Run menu command 1	[[ALT+Fn]]
<b>_pwbuser2</b>	.	[[ALT+Fn]]
<b>_pwbuser3</b>	.	[[ALT+Fn]]
<b>_pwbuser4</b>	.	[[ALT+Fn]]
<b>_pwbuser5</b>	.	[[ALT+Fn]]
<b>_pwbuser6</b>	.	[[ALT+Fn]]
<b>_pwbuser7</b>	.	[[ALT+Fn]]
<b>_pwbuser8</b>	.	[[ALT+Fn]]
<b>_pwbuser9</b>	Run custom Run menu command 9	[[ALT+Fn]]

**Menu**

Run *command*

*command* Title of custom Run menu item.

The **\_pwbusern** macros execute custom commands in the Run menu.

To add a new command to the Run menu, use the Customize Run Menu command or assign a value to the **User** switch.

**Definition**

`_pwbusern := cancel arg "n" usercmd <`

**Cancel**

Establishes a uniform “ground state” canceling any selection or argument.

**Arg "n" Usercmd**

Executes custom run menu item number *n*.

&lt;

Restores the function’s prompt (if any). By default, function prompts are suppressed while a macro is running.

**Example**

```
_pwbuser1 := cancel arg "1" usercmd <
```

This macro executes custom Run menu command number 1.

**See**

**Arg, Cancel, Usercmd**

---

## **\_pwbviewbuildresults**

**Key**

Unassigned

**Button**

The View Results button in the Build Operation Complete dialog box.

The **\_pwbviewbuildresults** macro opens the Build Results window.

PWB executes this macro when you choose the View Results button in the Build Operation Complete dialog box.

You can redefine this macro to change the behavior of the View Results button. For example, if you want to move to the first message in the log and arrange windows, add **\_pwbnextmsg \_pwbarrangewindow** to the end of the macro definition.

**Definition**

```
_pwbviewbuildresults:=cancel arg "<COMPILE>" pwbwindow
```

**Cancel**

Establishes a uniform “ground state” by canceling any selection or argument.

**Arg "<COMPILE>" Pwbwindow**

Opens the Build Results window.

**See**

**Pwbwindow**

## **`_pwbviewsearchresults`**

<b>Key</b>	Unassigned
<b>Button</b>	<p>The View Results button in the Search Operation Complete dialog box.</p> <p>The <code>_pwbviewSearchresults</code> macro opens the Search Results window.</p> <p>PWB executes this macro when you choose the View Results button in the Search Operation Complete dialog box.</p> <p>You can redefine this macro to change the behavior of the View Results button. For example, if you want to move to the first location in the log and arrange windows, add <code>_pwbnextsearch _pwbarrangewindow</code> to the end of the macro definition.</p>
<b>Definition</b>	<p><code>_pwbviewsearchresults:=cancel arg "&lt;SEARCH&gt;" pwbwindow</code></p> <p><b>Cancel</b> Establishes a uniform "ground state" by canceling any selection or argument.</p> <p><b>Arg "&lt;SEARCH&gt;" Pwbwindow</b> Opens the Search Results window.</p>
<b>See</b>	<b>Pwbwindow</b>

## **`_pwbwindow`**

<b>Macro</b>	<b>Description</b>	<b>Key</b>
<code>_pwbwindow1</code>	Switch to window 1	ALT+1
<code>_pwbwindow2</code>	.	ALT+2
<code>_pwbwindow3</code>	.	ALT+3
<code>_pwbwindow4</code>	.	ALT+4
<code>_pwbwindow5</code>	.	ALT+5
<code>_pwbwindow6</code>	.	ALT+6
<code>_pwbwindow7</code>	.	ALT+7
<code>_pwbwindow8</code>	.	ALT+8
<code>_pwbwindow9</code>	Switch to window 9	ALT+9

**Menu** Window *n file*  
*n* Window number  
*file* Current file in the window

The **\_pwbwindow** macros each set a specific numbered window as the active window.

**Definition** `_pwbwindow n := cancel arg "n" selwindow <`

**Cancel**

Establishes a uniform “ground state” by canceling any selection or argument.

**Arg "n" Selwindow**

Moves to window number *n*.

<

Restores the function’s prompt (if any). By default, function prompts are suppressed while a macro is running.

**Example** `_pwbwindow1 := cancel arg "1" selwindow <`

This macro sets window number 1 as the active window.

**See** Arg, Cancel, Selwindow

---

## PWB Switches

PWB provides the following switches to customize its behavior. You set switches by adding entries to the TOOLS.INI file or by using the Editor Settings, Key Assignments, and Colors commands on the Options menu.

Switch	Description
Askexit	Prompt before leaving PWB
Askrtm	Prompt before returning from a shell
Autoload	Load PWB extensions automatically
Autosave	Save files when switching
Backup	File backup mode
Beep	Issue audible or visible alerts
Build	Rules and definitions for the build process
Case	Make letter case significant in searches
Color	Color of interface elements

<b>Switch</b>	<b>Description</b>
Cursormode	Block or underline cursor state
Dbclick	Double-click threshold
Deflang	Default language
Defwinstyle	Default window style
Editreadonly	Allow editing of files marked read-only on disk
Enablealtgr	Enable the ALTGR key on non-US keyboards
Entab	Tab translation mode while editing
Enterinsmode	Enter PWB in insert mode
Enterlogmode	Enter PWB with search logging turned on
Enterselmode	Enter PWB in specified selection mode
Envcursave	Save environment variables for PWB sessions
Envprojsave	Save environment variables for projects
Factor	Auto-repeat factor
Fastfunc	Functions for fast auto-repeat
Filetab	Width of tab characters in the file
Friction	Delay between repetitions of fast functions
Height	Height of the display
Hike	Window adjustment factor
Hscroll	Horizontal scrolling factor
Infodialog	Set of information dialogs displayed
Keepmem	XMS/EMS memory kept during shell, build, and compile
Lastproject	Set the last project on startup
Load	PWB extension to load
Markfile	Name of the current mark file
Mousemode	Mouse configuration; disabled or swapped buttons
Msgdialog	Display a dialog box for build results
Msgflush	Keep only one set of build results
Newwindow	Create a new window when opening a file
Noise	Line counting interval
Printcmd	Command for printing files
Readonly	Command for saving disk read-only files
Realtabs	Preserve tab characters in the file
Restorelayout	Restore the window layout when a project is set
Rmargin	Right margin for word wrap
Savescreen	Preserve the operating-system screen

Switch	Description
Searchdialog	Display a dialog box for search results
Searchflush	Keep only one set of search results
Searchwrap	Make searches wrap around the end of the file
Shortnames	Allow access to loaded files by base name
Softer	Perform automatic indenting
Tabalign	Align the cursor in tab fields
Tabdisp	Character for displaying tab characters
Tabstops	Variable tab stops
Tilemode	Window tiling style
Timersave	Timer interval for saving files
Tmpsav	Number of files kept in file history
Traildisp	Character for displaying trailing spaces
Trailines	Preserve trailing lines
Trailinesdisp	Character for displaying trailing lines
Trailspace	Preserve trailing spaces
Undelcount	Maximum number of file backups
Undocount	Maximum number of edits per file to undo
Unixre	Use UNIX regular-expression syntax
User	Custom Run menu item
Vscroll	Vertical scrolling factor
Width	Width of the display
Word	Definition of a word
Wordwrap	Wrap words as they are entered

## Extension Switches

The standard PWB extensions define additional switches to control their behavior. You set these switches in tagged sections of TOOLS.INI specific to that extension.

PWB Extension	Description	TOOLS.INI Section Tag
PWBROWSE.MXT	Source Browser	[PWB-PWBROWSE]
PWBMASM.MXT	Assembly Language	[PWB-PWBMASM]
PWBHELP.MXT	Microsoft Advisor Help	[PWB-PWBHELP]

The PWBROWSE switches are described in “Browser Switches” on page 286. The PWBHELP switches are described in “Help Switches” on page 287.



## Filename-Parts Syntax

The filename-parts syntax is used by PWB to pass the name of the current file to external programs or operating-system commands. You use this syntax in the **Printcmd**, **Readonly**, and **User** switches.

**Syntax**            **%%**  
                          A literal percent sign (%).

**Syntax**            **%s**  
                          The fully qualified path of the current file. If the current file is a pseudofile, **%s** specifies the name of a temporary disk file created for the external command to operate on. The temporary file is destroyed before returning to PWB and is never accessible to the editor.

**Syntax**            **%l [[d]][[p]][[f]][[e]]F**  
                          Parts of the current filename. The parts of the name are drive, path, filename, and extension. If the current file is a disk file named:

C:\SCRATCH\TEST.TXT

or the pseudofile:

"<COMPILE>Build Results"

the given syntax yields:

Syntax	Disk File	Pseudofile
<b>%lF</b>	C:\SCRATCH\TEST.TXT	<COMPILE>
<b>%ldF</b>	C:	
<b>%lpF</b>	\SCRATCH	
<b>%lfF</b>	TEST	<COMPILE>
<b>%leF</b>	.TXT	
<b>%lpfF</b>	\SCRATCH\TEST	<COMPILE>
<b>%s</b>	C:\SCRATCH\TEST.TXT	C:\TMP\PWB00031.R00
<b>%%</b>	%	%

The title of a pseudofile cannot be specified with the filename-parts syntax, but it is accessible to macros by using the **Curfile** predefined macro.

---

**Warning** The **%lF** syntax always specifies the name of the current file in the active window. For some commands, such as the command specified in the **Readonly** switch, this may not be the desired file. Use **%s** for the **Readonly** switch.

---

See **Printcmd, Readonly, User**

## Boolean Switch Syntax

You can use either one of the following syntaxes to set Boolean switches in PWB:

**Syntax 1**      *switch* : [[ **yes** | **no** | **on** | **off** | **1** | **0** ]]

*switch*

The name of a PWB switch.

**yes, on, 1**

Enable the feature controlled by *switch*.

**no, off, 0**

Disable the feature controlled by *switch*.

**Syntax 2**      [[**no**]]*switch* :

*switch*

Enable the feature controlled by *switch*.

**no***switch*

Disable the feature controlled by *switch*.

---

## Askexit

**Type**            Boolean

The **Askexit** switch determines if PWB prompts for confirmation before returning to the operating system.

**Syntax**          **Askexit**: { **yes** | **no** }

**yes**    Prompt for confirmation before leaving PWB.

**no**    Do not prompt before leaving PWB.

**Default**        Askexit:no

**See**             **Exit**

---

## Asktrn

<b>Type</b>	Boolean  The <b>Asktrn</b> switch determines if PWB prompts before returning to PWB after running a shell or external command.
<b>Syntax</b>	<b>Asktrn:</b> { <b>yes</b>   <b>no</b> }  <b>yes</b> Prompt for confirmation before returning to PWB. This setting allows you to review the contents of the operating-system screen before returning to the editor.  <b>no</b> Do not prompt before returning to PWB.
<b>Default</b>	Asktrn:yes
<b>See</b>	<b>Shell</b>

---

## Autoload

<b>Type</b>	Boolean  The <b>Autoload</b> switch determines if PWB automatically loads its extensions on startup.  When the <b>Autoload</b> switch is <i>yes</i> , PWB automatically loads extensions whose names begin with "PWB" and are found in the same directory as PWB.EXE. PWB always loads extensions named in a <b>Load</b> switch.  If you disable automatic extension loading, you can load extensions as you need them by assigning a value to the Load switch as follows: <b>Arg load:</b> <i>pwbextension</i> Assign (ALT+A <b>load:</b> <i>pwbextension</i> ALT+=).  The <i>pwbextension</i> is the path of the extension's executable file. PWB automatically assumes the filename extension .MXT. You can specify an environment-variable path by using an environment-variable specifier.
<b>Syntax</b>	<b>Autoload:</b> { <b>yes</b>   <b>no</b> }  <b>yes</b> Automatically load PWB extensions on startup.

**no**

Do not automatically load PWB extensions on startup. Load only those extensions named in **Load** switches in TOOLS.INI.

**Default**

Autoload:yes

**Update**

PWB 1.x extensions are not compatible with PWB 2.0. They are refused when you request that they be loaded. Old extensions must be recompiled with the new extension-support libraries and header files. In some cases, old extensions must also be modified for use with PWB 2.00.

Updated Microsoft PWB 1.x extensions not included with this product are available by contacting Microsoft Product Support Services in the United States or your local Microsoft subsidiary.

---

## Autosave

**Type**

Boolean

The **Autosave** switch determines if PWB automatically saves the current file without prompting whenever you move to another file, exit PWB, or execute an external operation such as a shell, build, or compile.

When the **Autosave** switch is set to no, PWB maintains the contents of files in memory for internal operations, and prompts to save modified files on exit or for external operations such as a build. With this setting, PWB never saves a file unless you explicitly save it.

**Syntax**

**Autosave:**{ **yes** | **no** }

**yes** Automatically save files.

**no** Do not automatically save files.

**Default**

Autosave:no

**Update**

In PWB 1.x, the default value of **Autosave** is yes.

**See**

**Shell, Timersave**

## Backup

<b>Type</b>	Text
	The <b>Backup</b> switch determines what happens to the old copy of a file before the new version is saved to disk.
<b>Syntax</b>	<b>Backup:</b> [[ <i>undel</i>   <i>bak</i> ]]  (none) No backup: PWB overtypes the file. <b>undel</b> PWB moves the old file to a hidden directory so you can retrieve it with the UNDEL utility. The number of copies saved is specified by the <b>Undelcount</b> switch. <b>bak</b> The extension of the previous version of the file is changed to .BAK.
<b>Default</b>	Backup:bak

---

## Beep

<b>Type</b>	Boolean
	The <b>Beep</b> switch determines PWB's alerting method. When set to yes, PWB issues an audible sound. When no, PWB flashes the menu bar—a visual "beep."
<b>Syntax</b>	<b>Beep:</b> { <b>yes</b>   <b>no</b> }  <b>yes</b> Generate an audible beep.  <b>no</b> Flash the menu bar.
<b>Default</b>	Beep:yes

---

## Case

<b>Type</b>	Boolean
	The <b>Case</b> switch determines if letter case is distinguished in searches.

The search functions that use the **Case** switch have “meta” forms that temporarily reverse the sense of the **Case** switch.

The **Unixre** and **Case** switches have no effect on the syntax of regular expressions used by the **Build** or **Word** switches. These switches always use case-sensitive UNIX regular expressions.

**Syntax****Case:**{ **yes** | **no** }**yes**

Case is significant in searches. Uppercase letters in search patterns do not match lowercase letters in text.

**no**

Case is not significant in searches. Uppercase letters match lowercase letters.

**Default**

Case:no

**See****Meta, Mgrep, Mreplace, Msearch, Psearch, Replace.**

---

## Color

**Type**

Text

The **Color** switch specifies color of various parts of the PWB display.

**Syntax****Color:***name value**name*

Identifies the part of PWB affected by the color value.

*value*

Two hexadecimal digits specifying the foreground and background color of the indicated item.

**Color Names**

PWB uses the following color names and default color values for the various parts of the PWB display:

**Table 7.13 PWB Color Names**

<b>Name</b>	<b>Default Value</b>	<b>Description</b>
Alert	70	Message box
Background	07	(Not visible)
Border	07	Window borders

**Table 7.13 PWB Color Names** (*continued*)

<b>Name</b>	<b>Default Value</b>	<b>Description</b>
Builderr	40	Build message line in active window
Buttondown	07	Button while it is down
Desktop	80	Desktop
Dialogaccel	7F	Dialog box accelerator
Dialogaccelbor	7F	Dialog box accelerator border
Dialogbox	70	Dialog box
Disabled	78	Disabled items in menus and dialogs
Elevator	07	Scroll box
Enabled	70	Available items in menus and dialogs
Greyed	78	(Not visible)
Helpbold*	8F	Bold Help text
Helpitalic*	8A	Italic Help text and the characters
Helpnorm*	87	Plain Help text
Helpunderline*	8C	Emphasized Help text
Helpwarning*	70	Current hyperlink
Highlight	1F	Highlighted text; text found by searches
Hilitectrl	07	Highlighted control item
Info	3F	Special information
Itemhilitesel	0F	Highlighted character in selected item
Listbox	70	List box within a dialog box
Location	70	Location indicator in status bar
Menu	70	Menu bar
Menubox	70	Menu
Menuhilite	7F	Highlighted character in menu
Menuhilitesel	0F	Highlighted character in selected menu
Menuselected	07	Selected menu
Message	70	Message area of status bar
Pushbutton	70	Button that is not pressed
Pwbwindowborder	07	PWB window borders
Pwbwindowtext	87	PWB window text
Scratch	07	(Not visible)
Scrollbar	70	Gray area and arrows in scroll bar
Selection	71	Current selection
Shadow	08	Shadows

**Table 7.13 PWB Color Names** (*continued*)

Name	Default Value	Description
Status	7F	Indicator area of status bar
Text	17	Text in a window

\* Defined by the Help extension. Define these settings in the [PWB-PWBHELP] section of TOOLS.INI.

### Color Values

Color values for the **Color** switch are two hexadecimal digits that specify the color of the item. The first digit specifies the background color and the second digit specifies the foreground color, according to the following table:

**Table 7.14 PWB Color Values**

Color	Digit	Color	Digit
Black	0	Dark Gray	8
Blue	1	Bright Blue	9
Green	2	Bright Green	A
Cyan	3	Bright Cyan	B
Red	4	Bright Red	C
Magenta	5	Bright Magenta	D
Brown	6	Yellow	E
White	7	Bright White	F

For example, a setting of 3E displays a cyan background (3) and a yellow foreground (E).

Note that only color displays support all the colors listed. If you have a monochrome adapter or monochrome monitor, the only available colors are black (0), white (7), and bright white (F). All other colors are displayed as white.

---

## Cursormode

**Type**                      Numeric

The **Cursormode** switch determines the shape of the cursor when PWB is in insert and overtyping mode, according to the following table:



	<b>Cursormode Value</b>	<b>Insert Mode Cursor</b>	<b>Overtyp Mode Cursor</b>
	0	Underscore	Underscore
	1	Block	Block
	2	Block	Underscore
	3	Underscore	Block
<b>Default</b>	Cursormode:2		
<b>See</b>	<b>Status Bar</b>		

---

## Dblclick

**Type** Numeric

The **Dblclick** switch sets the double-click threshold for the mouse (the maximum time between successive clicks of the mouse button). The units for the **Dblclick** switch are 1/18 of a second.

**Default** Dblclick:10

**See** **Mousemode**

---

## Deflang

**Type** Text

The **Deflang** switch determines the default file extension for file lists in PWB dialog boxes.

**Syntax** Deflang:*language*

*language*

One of the following settings:

<b>Setting</b>	<b>Extension</b>
NONE	.*
Asm	.ASM
Basic	.BAS
C	.C

Setting	Extension
C++	.CPP
CXX	.CXX
COBOL	.CBL
FORTRAN	.FOR
LISP	.LSP
Pascal	.PAS

**Default** Deflang:NONE

---

## Defwinstyle

**Type** Numeric

The **Defwinstyle** switch sets the default window style. The possible values for **Defwinstyle** are:

Value	Style
1	No scroll bars
3	Vertical scroll bar
5	Horizontal scroll bar
7	Both scroll bars

You can change the active window style by using the **Winstyle** function (CTRL+F6).

**Default** Defwinstyle:7

**See** **Maximize**

---

## Editreadonly

**Type** Boolean

The **Editreadonly** switch determines if PWB allows you to edit a file marked read-only on disk.

---

<b>Syntax</b>	<b>Editreadonly:</b> { <b>yes</b>   <b>no</b> }
	<b>yes</b> Allow modification of files that are marked read-only on disk. When PWB attempts to save the modified file, PWB informs you that the file is marked read-only. It also prompts you to confirm that the command specified by the <b>Readonly</b> switch is to be run. If you decline to run the command, PWB gives you the opportunity to save the file with a different name.
	<b>no</b> Disallow modification of read-only files. For files that cannot be modified, PWB displays the letter R on the status bar. You can reenable modification of a read-only file by using the Read Only command on the Edit menu or the <b>Noedit</b> function.
<b>Default</b>	Editreadonly:yes

---

## Enablealtgr

<b>Type</b>	Boolean  The <b>Enablealtgr</b> switch determines if PWB recognizes the ALTGR key (the right ALT key) on international keyboards as ALTGR (Graphic Alt) or ALT.  When ALTGR is enabled, pressing ALTGR+ <i>key</i> produces the corresponding graphic character. ALTGR is never recognized as a key name for use in PWB key assignments.
<b>Syntax</b>	<b>Enablealtgr:</b> { <b>yes</b>   <b>no</b> }  <b>yes</b> Recognize the right ALT key as ALTGR.  <b>no</b> Recognize the right ALT key as ALT.
<b>Default</b>	Enablealtgr:no

---

## Entab

<b>Type</b>	Numeric  The <b>Entab</b> switch controls how PWB converts white space on modified lines. PWB converts white space only on the lines that you modify.
-------------	---

When the **Realtabs** switch is set to yes, tab characters are converted. When set to no, tab characters are not converted.

The **Entab** switch can have the following values:

Value	Meaning
0	Convert all white space to space (ASCII 32) characters.
1	Convert white space outside quoted strings to tabs.  A quoted string is any span of characters enclosed by a pair of single quotation marks or a pair of double quotation marks. PWB does not recognize escape sequences because they are language-specific.  For well-behaved conversions with this setting, make sure that you use a numeric escape sequence to encode quotation marks in strings or character literals.
2	Convert white space to tabs.

With settings 1 and 2, if the white space being considered for conversion to a tab character occupies an entire tab field or ends at the boundary of a tab field, it is converted to a tab (ASCII 9) character. The width of a tab field is specified by the **Filetab** switch.

In all conversions, PWB maintains the text alignment as it is displayed on screen.

**Default** Entab:1

**See** **Filetab, Realtabs, Tabalign**

---

## Enterinsmode

**Type** Boolean

The **Enterinsmode** switch determines if PWB is to start in insert mode or overwrite mode. You can toggle the current mode by using the **Insertmode** function (INS).

When the current mode is overwrite mode, the letter O appears on the status bar. Depending on the setting of the **Cursormode** switch, the shape of the cursor reflects the current mode.

**Syntax** **Enterinsmode**: { yes | no }

**yes** Start PWB in insert mode.

**no** Start PWB in overwrite mode.

**Default** Enterinsmode:yes

---

## Enterlogmode

**Type** Boolean

The **Enterlogmode** switch determines if search logging is turned on or off when PWB starts up. The current search-logging mode can be changed at any time using the Log command on the Search menu or the **Logsearch** function (Unassigned).

**Syntax** **Enterlogmode:**{ **yes** | **no** }

**yes** Start PWB with search logging on.

**no** Start PWB with search logging off.

**Default** Enterlogmode:no

---

## Enterselmode

**Type** Text

The **Enterselmode** switch determines the selection mode when PWB starts up.

**Syntax** **Enterselmode:**{ **stream** | **box** | **line** }

**stream**

Starts PWB in stream selection mode.

**box**

Starts PWB in box selection mode.

**line**

Starts PWB in line selection mode.

**Default** Enterselmode:stream

**See** **Selmode**

---

## Envcursave

**Type** Boolean

The **Envcursave** switch determines if PWB saves and restores the current environment table for PWB sessions.

You can change environment variables by using the Environment command on the Options menu or the **Environment** function (Unassigned).

If you always want to use the operating-system environment, set both **Envcursave** and **Envprojsave** to no.

**Syntax**

**Envcursave:**{ yes | no }

**yes**

Save and restore environment variables for PWB sessions. Use this setting if you want to use an environment that is specific to PWB. The PWB environment overrides the operating-system environment.

**no**

Do not save environment variables between PWB sessions.

**Default**

Envcursave:no

**Update**

In PWB 1.x, the INCLUDE, LIB, and HELPFILES environment variables were always saved for PWB sessions and projects.

---

## Envprojsave

**Type**

Boolean

The **Envprojsave** switch determines if PWB saves and restores the environment table for each project. A project's environment overrides both the PWB environment and the external (operating-system) environment.

If you always want to use the operating-system environment table, set both **Envcursave** and **Envprojsave** to no. You can change environment variables by using the Environment command on the Options menu or the **Environment** function (Unassigned).

**Syntax**

**Envprojsave:**{ yes | no }

**yes**

Save environment variables for the project. Use this setting if you want to set project-specific environments.

**no**

Do not save environment variables for the project.

**Default**

Envprojsave:yes

**Update**

In PWB 1.x, the INCLUDE, LIB, and HELPFILES environment variables were always saved for PWB sessions and projects.

## Factor

**Type** Text

The **Factor** switch, together with the **Friction** switch, controls how quickly PWB executes a fast function. A fast function is a PWB function whose action repeats as rapidly as possible while you hold down the associated keystroke.

**Syntax** **Factor**:{ *%percent* | *-constant* } [[*count*]]

*percent*

Percentage between 0 and 100 to reduce friction.

*constant*

Constant value between 0 and 65,535 to reduce friction.

*count*

Interval between reductions of friction.

PWB reduces friction by *percent* percent or *constant* every *count* repetition of a keystroke, until friction is zero.

**Default** Factor:%50 10

**Example** If you hold down the RIGHT ARROW key with the settings:

```
Right      :RIGHT
Fastfunc:Right
Friction:1000
Factor    :%75 7
```

PWB moves the cursor at the current speed until it has moved seven characters to the right. Then PWB changes the friction to 250 (75 percent reduction of the initial friction of 1000). When the cursor has moved 14 characters, the friction changes to 188 (75 percent reduction of the friction of 250). The cursor moves faster the longer you hold down the RIGHT ARROW key.

**See** **Fastfunc**

## Fastfunc

**Type**

Text

The **Fastfunc** switch specifies functions whose action is rapidly repeated by PWB as you hold down the associated key combination.

The **Friction** and **Factor** switches control the repeat speed and acceleration of fast functions.

**Syntax****Fastfunc:***function* {**on** | **off**}*function* PWB function to repeat.**on** Enable fast repeat for *function*.**off** Disable fast repeat for *function*.**Default**

Fastfunc:Down on  
Fastfunc:Left on  
Fastfunc:Mlines on  
Fastfunc:Mpage on  
Fastfunc:Mpara on  
Fastfunc:Mword on  
Fastfunc:Plines on  
Fastfunc:Ppage on  
Fastfunc:Ppara on  
Fastfunc:Pword on  
Fastfunc:Right on  
Fastfunc:Up on

---

## Filetab

**Type**

Numeric

The **Filetab** switch determines the width of a tab field for displaying tab (ASCII 9) characters in the file. The width of a tab field determines how white space is translated when the **Realtabs** switch is set to no. The **Filetab** switch does not affect the cursor-movement functions **Tab** (TAB) and **Backtab** (SHIFT+TAB).

**Default**

Filetab:8

**See****Entab, Realtabs, Tabdisp**



---

## Friction

**Type** Numeric

The **Friction** switch, together with the **Factor** switch, controls how quickly PWB executes a fast function. A fast function is a PWB function whose action repeats rapidly when you hold down the associated key.

The value of the **Friction** switch is a decimal number between 0 and 65,535 and specifies the delay between repetitions of a fast function. As the function is repeated, the delay is reduced according to the setting of the **Factor** switch.

**Default** Friction:40

**See** **Factor, Fastfunc**

---

## Height

**Type** Numeric

The **Height** switch determines the number of lines on the PWB screen. The **Height** switch can have one of these values: 25, 43, 50, or 60. The last setting of this switch is saved and restored across PWB sessions and for each project.

**Default** Height: *first screen height*

When you start PWB for the first time, PWB uses the current screen height. Thereafter, PWB restores the previous setting until you explicitly assign a new value to the **Height** switch.

Note that when you change the setting for **Height** in the Editor Settings dialog box, the change does not take effect until you choose OK. Other switches takes effect immediately when you choose Set Switch.

**See** **Assign**

## Hike

**Type** Numeric

The **Hike** switch determines the number of lines from the cursor to the top of the window after you move the cursor out of the window by more than the number of lines specified by the **Vscroll** switch.

The minimum value is 1. When the window occupies less than the full screen, the value is reduced in proportion to the window size.

**Default** Hike:4

**See** **Hscroll**

---

## Hscroll

**Type** Numeric

The **Hscroll** switch controls the number of columns that PWB scrolls the text left or right when you move the cursor out of the window. When the window does not occupy the full screen, the amount scrolled is in proportion to the window size.

Text is never scrolled in increments greater than the size of the window.

**Default** Hscroll:10

**See** **Vscroll**

---

## Infodialog

**Type** Numeric

The **Infodialog** switch determines which information dialog boxes are displayed.

**Syntax** **Infodialog:hh**

*hh*

Two hexadecimal digits specifying a set of flags to indicate which information dialog boxes should be displayed. When a bit is on (1), the corresponding dialog box is displayed. When a bit is off (0), the corresponding dialog box is not displayed.

To set the value of **Infodialog**, add up the hexadecimal numbers listed in the table below for the dialog boxes you want to display.

Value	Information Dialog
01	<i>n</i> occurrences found <i>n</i> occurrences replaced
02	End of Build Results End of Search Results
04	'pattern' not found
08	No unbalanced characters found
10	Changed directory to <i>directory</i> Changed drive to <i>drive</i>

**Default** Infodialog:0F

The default value of **Infodialog** tells PWB to display all information dialog boxes except for the "Changed..." dialog boxes.

---

## Keepmem

**Type** Numeric

The **Keepmem** switch specifies the amount of extended (XMS) memory or expanded (EMS) memory kept by PWB during a shell, compile, build, or other external command. Specify the value in units of kilobytes (1024 bytes).

A larger number means that shelling is faster and leaves less memory for tools that use extended or expanded memory. A smaller number means that shelling is slower and leaves more memory for tools. If the number you specify is not large enough, PWB uses no extended or expanded memory.

**Default** Keepmem:2048

---

## Lastproject

**Type** Boolean

The **Lastproject** switch determines if PWB automatically opens the last project on startup. The /PN, /PP, /PL, and /PF command-line options override the setting of the **Lastproject** switch.

<b>Syntax</b>	<b>Lastproject:</b> { yes   no } <b>yes</b> On startup, open the last project that was open. <b>no</b> Do not open the last project on startup.
<b>Default</b>	Lastproject:no
<b>See</b>	<b>Project</b>

---

## Load

<b>Type</b>	Text  The <b>Load</b> switch specifies the filename of a PWB extension to load.  When this switch is assigned a value, PWB loads the specified extension. The initialization specified in the extension is performed, and the functions and switches defined by the extension become available in PWB.  The extension can be loaded during initialization of a TOOLS.INI section. You can also interactively load an extension by using the Editor Settings command on the Options menu or by using the <b>Assign</b> function to assign a value to the <b>Load</b> switch.
<b>Syntax</b>	<b>Load:</b> [[ <i>path</i> ]] <i>basename</i> [[ <i>.ext</i> ]]  <i>path</i> Can be a path or an environment-variable specifier.  <i>basename</i> Base name of the extension executable file.  <i>ext</i> Normally you do not specify a filename extension.
<b>See</b>	<b>Autoload</b>

---

## Markfile

<b>Type</b>	Text  The <b>Markfile</b> switch specifies the name of the file PWB uses to save marks.
-------------	---

When no mark file is open, marks are kept in memory, and they are lost when you exit PWB. When you open a mark file, marks in memory are saved in the mark file, unless a mark file is already open. When a mark file is already open, the marks in memory are saved in the open file.

To open a mark file, use the Set Mark File command on the Search menu or assign a value to the **Markfile** switch by using the Editor Settings command on the Options menu or the **Assign** function. To close a mark file without opening a new one, assign an empty value to the **Markfile** switch. That is, use the setting:

Markfile:

To set a permanent mark file that is used for every PWB session, place a **Markfile** definition in the [PWB] section of TOOLS.INI.

**Syntax**

Markfile: *filename*

*filename* The name of the file containing mark definitions.

**Default**

Markfile:

The Markfile switch has no default value and is initially undefined.

**See**

**Assign, Mark**

**Mark File Format**

A mark file is a text file containing mark definitions of the form:

*markname filename line column*

The mark *markname* is defined as the location given by *line* and *column* in the file *filename*. The *markname* cannot contain spaces and cannot be a number.

**Update**

With PWB 1.x, when you open a mark file and no mark file is currently open, the marks in memory are lost. With PWB 2.00, the marks are saved in the new mark file.

---

## Mousemode

**Type**

Numeric

The **Mousemode** switch enables or disables the mouse and sets the actions of the left and right mouse buttons.

Value	Description
0	The mouse is disabled and the mouse pointer is not visible.
1	Normal mouse control.
2	Exchanges the actions of the left and right mouse buttons.

**Default** Mousemode:1

**See** **Dblclick**

---

## Msgdialog

**Type** Boolean

The **Msgdialog** switch determines if PWB brings up a dialog box summarizing build results or only beeps when a build is complete.

**Syntax** **Msgdialog**:{ **yes** | **no** }

**yes** Display a dialog box summarizing build results when a build is complete.

**no** Beep when a build is complete.

**Default** Msgdialog:yes

**See** **Beep, Compile, Searchdialog**

---

## Msgflush

**Type** Boolean

The **Msgflush** switch determines if previous build results are retained in the Build Results window or flushed when a new build is started.

**Syntax** **Msgflush**:{ **yes** | **no** }

**yes** Flush previous build results when a new build is started.

**no** Save previous build results.

**Default** Msgflush:yes

**See** **Nextmsg, Searchflush**

## Newwindow

**Type** Boolean

The **Newwindow** switch determines if certain PWB functions open a file in a new window or in the active window. The **Newwindow** switch provides the default state of the New Window check box in the Open File dialog box. This check box does not change the value of the **Newwindow** switch.

When **Newwindow** is set to yes, PWB behaves like a Multiple Document Interface (MDI) application. That is, when you open a new file, PWB opens a new window for the file, except in certain situations as noted below.

When **Newwindow** is set to no, PWB behaves like PWB 1.x. In this case, PWB opens files into the active window, creating a file history for that window. This mode is useful when working with large numbers of files.

Some functions use the **Newwindow** switch to determine if a new window is created when opening a file.

The following functions ignore the **Newwindow** switch, and either create a new window or open the file into the active window:

Function	Creates a New Window
<b>Mreplace</b>	No
<b>Openfile</b>	Yes
<b>Setfile</b>	No
<b>Nextmsg</b>	No
<b>Nextsearch</b>	No

When the active window is a PWB window, PWB always creates a new window. You cannot open a file into a PWB window.

**Syntax** **Newwindow**: { yes | no }

**yes**

Open a new window when a new file is opened. This setting makes PWB behave like other MDI applications such as Microsoft Word 5.5 and Microsoft Works.

**no**

Open files into the active window, adding the previous file to the window's file history. This setting makes PWB behave like PWB 1.x.

**Default** Newwindow:yes

**See** **Exit, Mark, Mreplace, Newfile, Nextmsg, Nextsearch, Openfile, Setfile**

## Noise

**Type** Numeric

The **Noise** switch specifies the number of lines counted at a time as PWB traverses a file while reading, writing, or searching. PWB displays the line counter on the right side of the status bar, in the area which usually shows the current line.

Set **Noise** to 0 to turn off the display of scanned lines.

**Default** Noise:50

---

## Printcmd

**Type** Text

The **Printcmd** switch specifies a program or operating system command that PWB starts when you choose the Print command from the File menu or execute the **Print** function (Unassigned).

**Syntax** **Printcmd:** *command\_line*

*command\_line* An operating-system command line.

To pass the filename of the current file, specify *%s* in the command line. Specify *%%* to pass a literal percent sign. You can extract parts of the full filename using a special PWB syntax. See “Filename-Parts Syntax” on page 247.

**Default** Printcmd: COPY %s PRN

**See** **Print**

---

## Readonly

**Type** Text

The **Readonly** switch specifies the operating-system command invoked when PWB attempts to write to a read-only file.

When PWB attempts to overtype a file that is marked read-only on disk, PWB informs you that the file is read-only. It also prompts you to confirm that the command specified in the **Readonly** switch is to be run. If you decline to run



the **ReadOnly** command, PWB gives you the opportunity to save the file with a different name.

**Syntax**

**ReadOnly:**[[*command*]]

*command* Operating-system command line.

If no command is specified, PWB prompts you to enter a new filename to save the file.

To pass the filename of the current file to the command, specify *%s* in the command line. Specify *%%* to pass a literal percent sign. You can extract parts of the full path using a special PWB syntax. See "Filename-Parts Syntax" on page 247.

Note that only *%s* is guaranteed to give the name of the read-only file. The *%IF* syntax gives the current filename (the file displayed in the active window), even when PWB is saving a different file.

**Default**

ReadOnly:

The default value specifies that PWB should run no command and should prompt for a different filename.

**Example**

The **ReadOnly** switch setting

```
ReadOnly:Attrib -r %s
```

removes the read-only attribute from the file on disk so PWB can overwrite it.

**See**

**Editreadonly, Noedit**

## Realtabs

**Type**

Boolean

The **Realtabs** switch determines if PWB preserves tab (ASCII 9) characters or translates white space according to the **Entab** switch when a line is modified.

**Realtabs** also determines if the **Tabalign** switch is in effect.

**Syntax**

**Realtabs:**{ **yes** | **no** }

**yes** Preserve tab characters when editing a line.

**no** Translate tab characters when editing a line.

**Default**

Realtabs:yes

**See**

**Entab, Filetab, Tabalign**

## Restorelayout

**Type** Boolean

The **Restorelayout** switch determines if PWB restores the saved window layout and file history from the project status file when you open a project or retains the active window layout and file history.

This switch provides the default state of the Restore Window Layout check box in the Open Project dialog box.

**Syntax** **Restorelayout**: { **yes** | **no** }

**yes**

Restore a project's saved window layout and file history when the project is opened.

**no**

Do not restore the project's windows and file history.

**Default** Restorelayout:yes

**See** **Project**

---

## Rmargin

**Type** Numeric

The **Rmargin** switch sets the right margin for word wrapping. It has an effect only when word wrapping is turned on.

**Default** Rmargin:78

**Update** In PWB 1.x, **Rmargin** sets the beginning of a six-character "probation" zone where typing a space wraps the line. After the zone, typing any character wraps the current word. This behavior is similar to that of a typewriter. PWB 2.00 uses a word-processor's style of wrapping.

To maintain the same margins as PWB 1.x, increase your **Rmargin** settings by 6.

**See** **Softcr**, **Wordwrap**

---

## Savescreen

<b>Type</b>	Boolean  The <b>Savescreen</b> switch determines if PWB preserves the operating-system screen image and video mode.
<b>Syntax</b>	<b>Savescreen:</b> { <b>yes</b>   <b>no</b> }  <b>yes</b> Save the operating-system screen when starting PWB, and restore it when leaving PWB.  <b>no</b> Do not preserve the operating-system screen. When you leave PWB, the operating-system screen is blank, and the video mode is left in PWB's last video mode.
<b>Default</b>	Savescreen:yes

---

## Searchdialog

<b>Type</b>	Boolean  The <b>Searchdialog</b> switch determines if PWB brings up a dialog box that summarizes logged search results or only beeps when a logged search is complete. The <b>Searchdialog</b> switch has an effect only while logging search results.
<b>Syntax</b>	<b>Searchdialog:</b> { <b>yes</b>   <b>no</b> }  <b>yes</b> Display a dialog box summarizing search results when a logged search is complete.  <b>no</b> Beep when a logged search is complete.
<b>Default</b>	Searchdialog:yes
<b>See</b>	<b>Beep, Enterlogmode, Logsearch, Msgdialog</b>

## Searchflush

<b>Type</b>	Boolean  The <b>Searchflush</b> switch determines if previous logged search results are flushed or retained when you start a new logged search.  This switch has an effect only when PWB performs a logged search.
<b>Syntax</b>	<b>Searchflush:</b> { <b>yes</b>   <b>no</b> }  <b>yes</b> Flush the previous search results from the Search Results window when a new search is begun.  <b>no</b> Preserve previous search results in the Search Results window.
<b>Default</b>	Searchflush:yes
<b>See</b>	<b>Logsearch, Mgrep</b>

---

## Searchwrap

<b>Type</b>	Boolean  The <b>Searchwrap</b> switch determines if search commands and replace commands wrap around the ends of a file.
<b>Syntax</b>	<b>Searchwrap:</b> { <b>yes</b>   <b>no</b> }  <b>yes</b> Searches wrap around the beginning and end of the file.  <b>no</b> Searches stop at the beginning and end of the file.
<b>Default</b>	Searchwrap:no
<b>See</b>	<b>Msearch, Psearch, Replace.</b>

---

## Shortnames

<b>Type</b>	Boolean  The <b>Shortnames</b> switch determines if currently loaded files can be accessed by their short names (base name only).
<b>Syntax</b>	<b>Shortnames:</b> { <b>yes</b>   <b>no</b> }  <b>yes</b> You can switch to a file currently loaded into PWB by specifying only the base name to the <b>Setfile</b> (F2) or <b>Openfile</b> (F10) functions.  <b>no</b> You must specify the extension as well as the base name to switch to a file.
<b>Default</b>	Shortnames:yes
<b>See</b>	<b>Openfile, Setfile</b>

---

## Softcr

<b>Type</b>	Boolean  The <b>Softcr</b> switch controls indentation of new lines based on the format of surrounding text when you execute the <b>Emacsnewl</b> (ENTER) and <b>Newline</b> (SHIFT+ENTER) functions.
<b>Syntax</b>	<b>Softcr:</b> { <b>yes</b>   <b>no</b> }  <b>yes</b> Indent new lines.  <b>no</b> Do not indent new lines. After executing <b>Emacsnewl</b> or <b>Newline</b> , the cursor is placed in column 1.
<b>Default</b>	Softcr:yes

## Tabalign

**Type** Boolean

The **Tabalign** switch determines the positioning of the cursor when it enters a tab field. A tab field is the area of the screen representing a tab character (ASCII 9) in the file. The width of a tab field is specified by the **Filetab** switch.

The **Tabalign** switch takes effect only when the **Realtabs** switch is set to yes.

**Syntax** **Tabalign**: { yes | no }

**yes**

PWB aligns the cursor to the beginning of the tab field when the cursor enters the tab field. The cursor is placed on the actual tab character in the file.

**no**

PWB does not align the cursor within the tab field.

You can place the cursor on any column in the tab field. When you type a character at this position, PWB inserts enough leading blanks to ensure that the character appears in the same column.

**Default** Tabalign:no

---

## Tabdisp

**Type** Numeric

The **Tabdisp** switch specifies the decimal ASCII code of the character used to display tab (ASCII 9) characters in your file. If you specify 0 or 255, PWB uses the space (ASCII 32) character.

It is sometimes useful to set **Tabdisp** to the code for a graphic character so that tabs can be distinguished from spaces.

**Default** Tabdisp:32

The default value 32 specifies the ASCII space character.

**See** **Filetab**, **Realtabs**, **Traildisp**, **Trailinesdisp**

## Tabstops

<b>Type</b>	Text
	<p>The <b>Tabstops</b> switch specifies variable tab stops used by the <b>Tab</b> and <b>Backtab</b> functions. <b>Tab</b> moves the cursor to the next tab stop; <b>Backtab</b> moves the cursor to the previous tab stop.</p> <p>Note that the <b>Tabstops</b> switch has no effect on the handling of tab (ASCII 9) characters in a file.</p>
<b>Syntax</b>	<p><b>Tabstops:</b> <code>[[<i>tabwidth</i>]]... repeat</code></p> <p><i>tabwidth</i></p> <p>The width of a tab stop. You can repeat <i>tabwidth</i> for as many tab stops as will fit on a PWB line (250 characters).</p> <p><i>repeat</i></p> <p>The width of every tab stop after the explicitly listed tab stops. A value of 0 for <i>repeat</i> specifies that there are no tab stops after the list of <i>tabwidth</i> settings. When the cursor is past the last tab stop, the <b>Tab</b> function does nothing.</p>
<b>Default</b>	Tabstops:4
<b>Update</b>	In PWB 1.x, <b>Tabstops</b> is a numeric switch specifying a single value, equivalent to the repeat value in PWB 2.0. The default PWB 2.00 <b>Tabstops</b> setting mimics the default behavior of PWB 1.x.
<b>Example</b>	<p>The <b>Tabstops</b> switch setting</p> <pre>Tabstops:4</pre> <p>sets a tab stop every four columns.</p>
<b>Example</b>	<p>The setting</p> <pre>Tabstops:3 4 7 8</pre> <p>sets a tab stop at columns 4, 8, 15, and every eight columns thereafter.</p>
<b>Example</b>	<p>The setting</p> <pre>Tabstops:3 4 7 25 25 0</pre> <p>sets a tab stop at columns 4, 8, 15, 40, and 65. When the cursor is past column 65, the <b>Tab</b> function does nothing.</p>
<b>See</b>	<b>Backtab, Entab, Filetab, Realtabs, Tab</b>

# Tilemode

**Type** Numeric

The **Tilemode** switch specifies the window tiling style. It can take one of the values below:

Value	Tiling Style
0	The first three windows are stacked one above the other.
1	The top two windows are tiled side-by-side.

When four or more windows are open, the tiling is the same in the two styles.

In stacked style (`Tilemode:0`), the top windows are placed one above the other, as shown in gray.

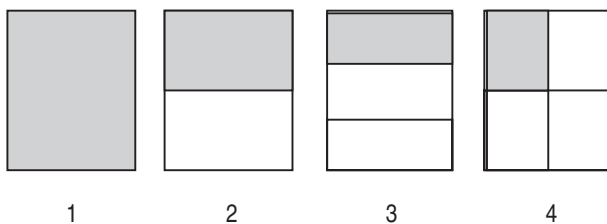

**Figure 7.2 Vertical Tiling**

In side-by-side style (`Tilemode:1`), the top two windows are tiled next to each other, as shown in Figure 7.3. This arrangement is good for comparing two files.

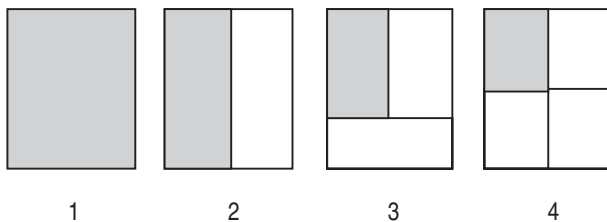

**Figure 7.3 Horizontal Tiling**

**Default** `Tilemode:0`

**See** **Arrangewindow**



---

## Timersave

**Type** Numeric

The **Timersave** switch sets the interval in seconds between automatic file saves. The value must be in the range 0-65,535.

Set **Timersave** to 0 to turn off time-triggered autosave.

**Default** Timersave:0

**See** **Autosave**

---

## Tmpsav

**Type** Numeric

The **Tmpsav** switch determines the maximum number of files kept in the file history between sessions.

When **Tmpsav** is 0, PWB lets the file history grow without limit; all files loaded into PWB appear in this list until you delete the CURRENT.STS file or change the value of the **Tmpsav** switch.

**Default** Tmpsav:20

---

## Traildisp

**Type** Numeric

The **Traildisp** switch specifies the decimal ASCII code for the character used to display trailing spaces on a line. If you specify 0 or 255, PWB uses the space (ASCII 32) character.

**Default** Traildisp:0

**See** **Trallines**, **Trailspace**, **Trallinesdisp**

## Traillines

**Type** Boolean

The **Traillines** switch determines if PWB preserves or removes empty trailing lines in a file when the file is written to disk.

You can make trailing lines visible by setting the **Traillinesdisp** switch to a value other than 0 or 32.

**Syntax** **Traillines**: { **yes** | **no** }

**yes** Preserve trailing blank lines in the file.

**no** Remove trailing blank lines from the file.

**Default** Traillines:no

**See** **Traildisp**, **Trailspace**

---

## Traillinesdisp

**Type** Numeric

The **Traillinesdisp** switch specifies the decimal ASCII code for the character displayed in the first column of blank lines at the end of the file. If you specify 0 or 255, PWB uses the space (ASCII 32) character.

**Default** Traillinesdisp:32

**See** **Traillines**, **Traildisp**, **Trailspace**

---

## Trailspace

**Type** Boolean

The **Trailspace** switch determines if PWB preserves or removes trailing spaces from modified lines.

You can make trailing spaces visible by setting the **Traildisp** switch to a value other than 0 or 32.

---

<b>Syntax</b>	<b>Trailspace:</b> { <b>yes</b>   <b>no</b> }
	<b>yes</b> Preserve trailing spaces on lines as they are changed.
	<b>no</b> Remove trailing spaces from lines as they are changed.
<b>Default</b>	Trailspace:no
<b>See</b>	<b>Trallines</b> , <b>Trallinesdisp</b>

---

## Undelcount

<b>Type</b>	Numeric
	The <b>Undelcount</b> switch determines the maximum number of backup copies of a given file saved by PWB.
	This switch is used only when the <b>Backup</b> switch is set to <code>undel</code> .
<b>Default</b>	Undelcount:32767

---

## Undocount

<b>Type</b>	Numeric
	The <b>Undocount</b> switch sets the maximum number of edits per file that you can reverse with <b>Undo</b> (ALT+BKSP).
<b>Default</b>	Undocount:30

---

## Unixre

<b>Type</b>	Boolean
	The <b>Unixre</b> switch determines if PWB uses UNIX regular-expression syntax or PWB's non-UNIX regular-expression syntax for search-and-replace commands.
	The <b>Unixre</b> and <b>Case</b> switches have no effect on the syntax of regular expressions used by the <b>Build</b> and <b>Word</b> switches. These switches always use case-sensitive UNIX regular-expression syntax.

<b>Syntax</b>	<b>Unixre:</b> { <b>yes</b>   <b>no</b> } <b>yes</b> Use UNIX regular-expression syntax when searching. <b>no</b> Use non-UNIX regular-expression syntax when searching.
<b>Default</b>	Unixre:yes

---

## User

<b>Type</b>	Text The <b>User</b> switch adds a custom menu item to the PWB Run menu.
<b>Syntax</b>	<b>User:</b> <i>title</i> , <i>path</i> , [[ <i>arg</i> ]], [[ <i>out</i> ]], [[ <i>dir</i> ]], [[ <i>help</i> ]], [[ <i>prompt</i> ]], [[ <i>ask</i> ]], [[ <i>back</i> ]], [[ <i>key</i> ]] If any argument to the <b>User</b> switch contains spaces, it must be enclosed in double quotation marks. <i>title</i> Menu title for the program to be added. No other command can have the same title. Prefix the character to be highlighted as the access key with a tilde (~) or ampersand (&). If you do not specify an access key, the first letter of the title is used. <i>path</i> Full path of the program. If the program is on the PATH environment variable, you can specify just the filename of the program. <i>arg</i> Command-line arguments for the program. To pass the name of the current file to the program, specify %s in the command line. Default: no arguments. <i>out</i> Name of a file to store program output. If no file is specified and the program is run in the foreground, the current file in PWB receives the output. Default: no output file. <i>dir</i> Current directory for the program. Default: PWB's current directory. <i>help</i> Text that appears on the status bar when the menu item is selected. Default: no help text. <i>prompt</i> Determines if PWB prompts for command-line arguments. The value of <i>arg</i> is the default response. Specify <b>Y</b> to prompt or any other character to run the program without prompting for arguments. Default: no prompt.

*ask*  
 Determines if PWB is to prompt for a keystroke before returning to PWB. Specify **Y** to prompt or any other character to return to PWB immediately after running the program. Default: return without prompting.

*back*  
 Determines if the program is run in the background under a multithreaded environment. Specify **Y** to run the program in the background or any other character to run it in the foreground. If you run the program in the background, you must also specify *output*. Default: run the program in the foreground.

*key*  
 A single digit from 1 to 9, specifying a key from ALT+F1 to ALT+F9 as the shortcut key for the command. Default: no shortcut key.

**Default** By default, no custom menu commands are defined.

**Example** The **User** switch setting

```
User : "~Print", XPRINT, "/2 %s", LPT1, , \
      "Print the current file with XPRINT", y, n, n, 8
```

specifies the following custom Run menu command:

Option	Description
<i>title</i>	The menu title is <code>Print</code> with the accelerator <code>P</code> .
<i>path</i>	The XPRINT program is expected to be on the PATH.
<i>arg</i>	The default command line specifies the <code>/2</code> option and the current filename.
<i>out</i>	The program output is redirected to the LPT1 device.
<i>dir</i>	The XPRINT program is run in the current directory.
<i>help</i>	The Help line is <code>Print the current file with XPRINT</code> .
<i>prompt</i>	PWB prompts for additional arguments.
<i>ask</i>	PWB doesn't prompt before returning from XPRINT.
<i>back</i>	The XPRINT program is to run in the foreground.
<i>key</i>	ALT+F8 runs the XPRINT program after prompting.

The backslash at the end of the first line of the definition is a TOOLS.INI line continuation.

**See** **Printcmd, \_pwbuser*n*, Usercmd**

## Vscroll

**Type** Numeric

The **Vscroll** switch controls the number of lines scrolled up or down when you move the cursor out of the window. When the window is smaller than the full screen, the amount scrolled is in proportion to the window size.

The minimum value for **Vscroll** is 1. Text is never scrolled in increments greater than the size of the window.

The **Mlines** and **Plines** functions also scroll according to the value of the **Vscroll** switch.

**Default** Vscroll:1

**See** **Hscroll**

---

## Width

**Type** Numeric

The **Width** switch controls the width of the display. Only an 80-column display is supported.

**Default** Width:80

**See** **Height**

---

## Word

**Type** Text

**Syntax** **Word:** "*regular\_expression*"

*regular\_expression*

A macro string specifying a UNIX-syntax regular expression that matches a word.

The **Word** switch specifies a case-sensitive UNIX regular expression that matches a word. The **Unixre** and **Case** switches are ignored.

The **Word** switch accepts a TOOLS.INI macro string. The string can use escape sequences to represent nonprintable ASCII characters. Note that backslashes (\) must be doubled within a macro string.

The **Word** switch is used by functions that operate on words: **Mword**, **Pword**, **Pwbhelp**, right-clicking the mouse for Help, and double-clicking the mouse to select a word.

**Default**

Word:"[a-zA-Z0-9\_\$]+"

The default value mimics the behavior of PWB 1.x.

**Examples**

The **Word** switch can be used to change the definition of a word. The following examples show some useful word definitions.

The following setting works the same way as the default setting, except that **Pword** and **Mword** stop at the end of a line:

```
Word: "\\{ [a-zA-Z0-9_$]+\\!$\\ }
```

The default setting of the **Word** switch matches Microsoft C/C++ identifiers and unsigned integers. To restrict the definition of a word to match the ANSI C standard for identifiers, you would use the setting:

```
Word: " [a-zA-Z_] [a-zA-Z0-9_] * "
```

Another useful setting is to define a word as a contiguous stream of non-space characters:

```
Word: "[^ \t]+"
```

The following **Word** setting defines a word as an identifier or unsigned integer, a stream of white space, a stream of other characters, or the beginning or end of the line. This causes the word-movement functions to stop at each boundary, and allows a double-click to select white space.

```
Word: "\\{ [a-zA-Z0-9_$]+\\! [ ]+\\! [^a-zA-Z0-9_$]+\\!$\\!^\\ }
```

## Wordwrap

**Type** Boolean

The **Wordwrap** switch determines if PWB performs automatic word wrap as you enter text.

When word wrapping is turned on and you type a nonspace character past the column specified by **Rmargin**, PWB brings the current word down to a new line. A word is defined by the **Word** switch.

**Syntax** **Wordwrap**:{ **yes** | **no** }

**yes** Wrap words as you enter text.

**no** Do not wrap.

**Default** Wordwrap:no

**Update** See **Rmargin**

---

## Browser Switches

The PWBBROWSE extension provides the following switches to control the behavior of the Source Browser in PWB.

## Browcase

**Type** Numeric

The **Browcase** switch determines the initial case sensitivity of the browser when a database is opened. The browser consults this switch only when it opens the database.

This switch must appear in the [PWB-PWBROWSE] tagged section of TOOLS.INI.

A dot appears next to the Match Case command on the Browse menu when the browser matches case. Choose Match Case to turn case-sensitive browsing on and off. Changing the current state does not affect the value of the **Browcase** switch.



---

<b>Syntax</b>	<b>Browcase:</b> { 0   1   2 }
	0 Use the case sensitivity stored in the database by BSCMAKE. The default case sensitivity matches the case sensitivity of the source language.
	1 Match case for browse queries.
	2 Ignore case for browse queries.
<b>Default</b>	Browcase:0

---

## Browdbase

<b>Type</b>	Text
	The <b>Browdbase</b> switch specifies the browser database to use. When this switch is not set, or the setting is empty, the browser uses the database for the current project (if any). You set this switch by using the Save Current Database command in the Custom Database Management dialog box.
	This switch must appear in the [PWB-PWBROWSE] tagged section of TOOLS.INI.
<b>Syntax</b>	<b>Browdbase:</b> <i>database</i>
	<i>database</i> The full filename of the browser database (.BSC file) to use. When <i>database</i> is not specified, the browser uses the database for the open project.

---

## Help Switches

The PWBHELP extension provides the following switches to control the behavior of the Help system in PWB.

## Color (Help Colors)

The PWBHELP extension defines the following Color switches to set the colors for items displayed in the Help window. These switches must appear in the [PWB-PWBHELP] tagged section of TOOLS.INI. When you choose OK in the Save Colors dialog box, PWB automatically writes the new settings to the correctly tagged section of TOOLS.INI.

Name	Default Value	Description
Color: Helpnorm	87	Plain Help text
Color: Helpbold	8F	Bold Help text
Color: Helpitalic	8A	Italic Help text and the characters
Color: Helpunderline	8C	Emphasized Help text
Color: Helpwarning	70	Current hyperlink

For a complete description of the **Color** switch, see **Color**.

## Helpautosize

### Type

Boolean

The **Helpautosize** switch determines if PWB displays the Help window according to the size of the current topic or displays Help with its previous size and position.

This switch must appear in the [PWB-PWBHELP] tagged section of TOOLS.INI.

### Syntax

**Helpautosize:** { **yes** | **no** }

#### yes

When displaying a new topic, automatically resize the Help window to the size of the topic.

#### no

Do not automatically resize the Help window. The Help window is displayed with its previous size and position.

### Default

Helpautosize:no

### Update

In PWB 1.x, the Help window is always automatically resized. In PWB 2.00, the Help window is not resized by default.

---

## Helpfiles

<b>Type</b>	Text
	<p>The <b>Helpfiles</b> switch lists Help files or directories containing Help files that PWB should open in addition to the Help files listed in the HELPFILES environment variable.</p> <p>This switch must appear in the [PWB-PWBHELP] tagged section of TOOLS.INI.</p>
<b>Syntax</b>	<p><b>Helpfiles:</b> [[<i>file</i>]][[:<i>file</i>]]...</p> <p><i>file</i></p> <p>The filename of a Help file to open or the name of a directory. If a directory name is used, all Help files in the directory are opened. Each <i>file</i> can contain wildcards or environment-variable specifiers.</p>
<b>Default</b>	<p>Helpfiles:</p> <p>By default, PWB uses only the Help files in the current directory and those listed in the HELPFILES environment variable.</p>

---

## Helplist

<b>Type</b>	Boolean
	<p>The <b>Helplist</b> switch determines if PWB searches every Help file when you request Help or displays the first occurrence of the topic that it finds.</p> <p>This switch must appear in the [PWB-PWBHELP] tagged section of TOOLS.INI.</p>
<b>Syntax</b>	<p><b>Helplist:</b> { <b>yes</b>   <b>no</b> }</p> <p><b>yes</b></p> <p>Displays a list of Help files that contain the topic you requested Help on when the topic is defined more than once.</p> <p><b>no</b></p> <p>Does not display a list of topics. PWB displays the first Help associated with the requested topic. To see the other Help screens that define the topic, use the Next command on the Help menu.</p>
<b>Default</b>	Helplist: yes

# Helpwindow

(obsolete)

The PWB 1.x **Helpwindow** switch is obsolete and does not exist in PWB 2.00. PWB 2.00 always displays Help in the Help window.

P A R T 2

# The CodeView Debugger

Chapter 8 Getting Started with CodeView .....	293
Chapter 9 The CodeView Environment .....	319
Chapter 10 Special Topics .....	351
Chapter 11 Using Expressions in CodeView .....	375
Chapter 12 CodeView Reference .....	393



## CHAPTER 8

## Getting Started with CodeView

Microsoft CodeView is a window-oriented debugging tool that helps you find and correct errors in MASM and Microsoft C/C++ programs. With CodeView, you can examine source-level code and the corresponding compiled code at the same time. You can execute your code in increments and view and modify data in memory as your program runs.

Your MASM 6.10 package includes CodeView for MS-DOS (CV.EXE) and CodeView for Windows (CVW.EXE). The names “CodeView,” “CodeView debugger,” and “the debugger” refer to both versions unless the discussion indicates otherwise.

This chapter shows you how to:

- ◆ Write programs to make debugging easier.
- ◆ Formulate a debugging strategy.
- ◆ Compile and link your programs to include Microsoft Symbolic Debugging Information.
- ◆ Set up the files CodeView needs.
- ◆ Configure CodeView with TOOLS.INI.
- ◆ Start CodeView and load a program.
- ◆ Use the CodeView command-line options.
- ◆ Use or disable the CURRENT.STS state file.

## Preparing Programs for Debugging

You can use CodeView to debug any MS-DOS or Windows-based executable file produced from MASM or Microsoft C/C++ source code. “Compiling” means producing object code from source files. All references to compiling also apply to assembling unless stated otherwise.

## General Programming Considerations

This section describes programming practices that make debugging with CodeView easier and more efficient.

### Multiple Statements on a Line

CodeView treats each source-code line as a unit. For this reason, you cannot trace and set a breakpoint on more than one statement per line. You can change from Source display mode to Mixed or Assembly display mode (see “The Source Windows” on page 324) and then set breakpoints at individual assembly instructions. If a single statement is broken across multiple lines, you may be able to set breakpoints on only the starting or ending line of the statement.

### Macros and Inline Code

Microsoft C, C++, and MASM support macro expansion. Microsoft C and C++ also support inline code generation. These features pose a debugging problem because a macro or an inlined function is expanded where it is used, and CodeView has no information about the source code. This means that you cannot trace or set breakpoints in a macro or inlined function when debugging at the source level.

To work around this condition, you can:

- ◆ Manually expand the macro to its corresponding source code.
- ◆ Rewrite the macro as a function.
- ◆ Suppress inline code generation with the `/Ob0` compiler option.

You can often rewrite macros as inline functions, then selectively disable inlining with a compiler option or pragma so that you can step and trace the routine. Rewriting macros as inlined functions can have additional benefits such as argument type checking. However, in some cases the best solution for debugging macros or inline code is to use Assembly or Mixed display mode.

### Segment Ordering and Naming

For assembly-language programs, you must declare your segments according to the standard Microsoft high-level language format. MASM versions 5.10 and later provide directives to specify the standard segment order and naming.

### Programs that Alter the Environment

Programs that run under CodeView can read the environment table, but they cannot permanently change it. When you exit CodeView, changes to the environment are lost.



## Programs that Access the Program Segment Prefix

CodeView processes the command line in the program segment prefix (PSP) the same way as the C/C++ run-time library does. Quotation marks are removed, and exactly one space is left between command-line arguments. As a result, a program that accesses the PSP directly cannot expect the command line to appear exactly as typed.

## Compiling and Linking

After you compile and link your program into a running executable file, you can begin debugging with CodeView. To take full advantage of CodeView, however, you must compile and link with the options that generate CodeView Symbolic Debugging Information. This book refers to this information as “CodeView information,” “debugging information,” or “symbolic information.”

The CodeView information tells CodeView about:

- ◆ All program symbols, including locals, globals, and publics
- ◆ Data types
- ◆ Line numbers
- ◆ Segments
- ◆ Modules

Without this information, you cannot refer to any source-level names, and you can view the program only in Assembly display mode. When CodeView loads a module that does not contain symbolic information, CodeView starts in Assembly mode and displays the message:

```
CV0101 Warning: No symbolic information for PROGRAM.EXE
```

You get this message if you try to debug an executable file that you did not compile and link with CodeView options, if you use a compiler that does not generate CodeView information, or if you link your program with an old version of the linker. If you retain an old linker version and it is first in your path, the proper information may not be generated for CodeView.

You can specify CodeView compiler and linker options from the command line, in a makefile, or from within the Microsoft Programmer's Workbench (PWB). To compile and link your program with CodeView options from PWB, choose Build Options from the Options menu, and turn on Use Debug Options. By default, all project templates enable the generation of CodeView information for debug builds.

## Assembler/Compiler Options

You can specify CodeView options when you assemble a source file of a program you want to debug. Specify the `/Zi` option on the command line or in a makefile to instruct the assembler to include line-number and complete symbolic information in the object file.

Symbolic information takes up a large amount of space in the executable file and in memory while debugging. If you do not need full symbolic information in some modules, compile those modules with the `/Zd` option. The `/Zd` option specifies that only line numbers and public symbols are included in the object file. In such modules you can view the source file and examine and modify global variables, but type information and names with local scope are not available.

For modules that are assembled or compiled with the `/Zd` option, all names in that module are displayed and can only be referred to using their “decorated name.” The decorated name is the form of the name in the object code produced by the compiler. With full debugging information, CodeView can translate between the source form of the name and the decorated name.

Name decoration encodes additional information into a symbol’s name by adding prefixes and suffixes. For example, the C compiler prefixes the names of functions that use the C calling convention with an underscore. You often see decorated names for library routines in disassembly or output from the Examine Symbols (**X**) command. For more information on decorated names, see “Symbol Formats” on page 385.

All Microsoft high-level language compilers are optimizing compilers that may rearrange and remove source code. As a result, optimizations destroy the correspondence between source lines and generated machine code, which can make debugging especially difficult. While you are debugging, you should disable optimizations with the `/Od` compiler option. When you finish debugging, you can compile a final version of your program with full optimizations.

---

**Note** The `/Od` option does not pertain to MASM.

---

## Linker Options

When you are using Microsoft C/C++ or the Microsoft Assembler, you must use the Microsoft Segmented Executable Linker (LINK) version 5.30 or later to generate an executable file with CodeView information. If you include debugging options when you compile, the compiler automatically invokes the linker with the appropriate options. In turn, LINK runs the CVPACK utility, which compresses the symbolic information.

When compiling, you can specify the compile-only (`/c`) option to disable running LINK. To include debugging information when you link the object modules

separately, specify the LINK /CO option. LINK automatically runs CVPACK when you specify /CO.

If you link with the /EXEPACK option, you must execute the program's startup code before setting breakpoints in the program. If you set breakpoints in a packed executable file before the startup code has executed, CodeView behavior is unpredictable.

An executable file that includes debugging information can be executed from the command line like any other program. However, to minimize the size of the final version of the program, compile and link without the CodeView options.

### Examples

The following command sequence assembles and links two files:

```
ML /C /Zi MOD1.ASM
ML /C /Zd MOD2.ASM
LINK /CO MOD1 MOD2
```

This example produces the object file MOD1.OBJ, which contains line-number and complete symbolic information, and the object file MOD2.OBJ, containing only line-number and public-symbol information. The object files are then linked to produce a smaller file than the file that is produced when both modules are assembled with the /Zi option.

The following commands produce a mixed-language executable file:

```
CL /Zi PROG.CPP
CL /Zi /Od /c /AL SUB1.C
ML /C /Zi /MX SUB2.ASM
LINK /CO PROG SUB1 SUB2
```

You can use CodeView to trace through C, C++, and MASM source files in the same session.

## Debugging Strategies

The process of debugging a program varies from programmer to programmer and program to program. This section offers some guidelines for detecting bugs. If you are familiar with symbolic, source-level debuggers, you can skip this section.

### Identifying the Bug

If your program crashes or yields incorrect output, it has a bug. There are times, however, when a program runs correctly with some input but produces incorrect output or crashes with different input. You can assume a bug exists, but finding it may be difficult.

## Locating the Bug

You may not need to use CodeView to find bugs in simple programs. For more complex programs, however, using CodeView can save you debugging time and effort.

### Setting Breakpoints

When you debug with CodeView, you usually cycle between two activities:

- ◆ Running a small part of the program
- ◆ Stopping the program to check its status

You use breakpoints to switch between these tasks. CodeView runs your program until it reaches a breakpoint. At that time, CodeView gives you control. You can then enter CodeView commands in the Command window or use the menus and shortcut keys to proceed.

To find an error, try the following:

- ◆ Set breakpoints around the place you think the bug might be. Execute the program with the Go command so that it runs at full speed until it reaches the area that you suspect harbors the bug. You can then execute the program step by step with the Program Step and Trace commands to see if there is a program execution error.
- ◆ Set breakpoints when certain conditions become true. You can, for example, set a breakpoint to check a range of memory starting at DS:00, the base of your program's data. If your program writes to memory using a null pointer, the breakpoint is taken, and you can see what statement or variables within the statement are in error.

### Setting Watch Expressions

Watch expressions constantly display the values of variables in the Watch window. By setting a Watch expression, you can see how a variable or an expression changes as your program executes.

Try using watch expressions as follows:

- ◆ Set a Watch expression on an important variable. Then step through a part of the program where you suspect there is a bug. When you see a variable in the Watch window take on an unexpected value, you know that there is probably a bug in the line you just executed.

- ◆ Explore Watch expressions. A bug can appear when your program builds complex data structures. Both the Watch window and the Quick Watch dialog box allow you to explore the data structure by expanding arrays and pointers. Use this feature to make sure the program creates the data structure correctly. As soon as you execute code that destroys the structure, you have probably found a bug.

## Arranging Your Display

Your display can be more effective if you arrange your windows so that they display the information you need. You will need at least one Source window. You can open a second Source window to see each assembly-language instruction.

You may also need one or more Memory windows to examine ranges of memory in various formats. You may want to change values in memory. For example, a program that does its own dynamic-memory allocation may need an initialized block of memory. You can edit memory directly in the Memory window or fill the block with zeros using the Memory Fill command. If a certain value is required for a mathematical function, you can type over values displayed in the Memory window or assign the value in the Command window. If you expect a value to appear at a certain location and it does not, you can use the Memory Search command to find it.

Use the Register window to see the CPU registers and the Local and Watch windows to keep track of changing variable values. Open the Calls menu to examine your program's stack to see what routines have been called.

You can set up CodeView's windows to display the information you want to see by using keyboard commands or the commands in the Window menu. For example, when you press SHIFT+F5 or choose Tile from the Windows menu, CodeView arranges all open windows to fill the entire window area. When the windows are tiled, you can press ALT+F5 or choose Arrange from the Windows menu. This allows you to move your open windows with a mouse so that you can view several or all of them at once.

## Setting up CodeView

The MASM SETUP program installs all the necessary CodeView files. Make sure that all of the CodeView executable files (.EXE and .DLL files) are in a directory listed in the PATH environment variable.

In addition, SETUP creates TOOLS.PRE in the INIT directory that you specify when you run SETUP. If you do not already have a TOOLS.INI file, rename TOOLS.PRE as TOOLS.INI.

This file contains the recommended settings to run CodeView for MS-DOS and CodeView for Windows. For more information on the entries in TOOLS.INI, see "Configuring CodeView with TOOLS.INI" on page 301.

CodeView version 4.0 introduces a new, flexible architecture for the debugger. CodeView is made up of a main executable program: CV.EXE (CodeView for MS-DOS) or CVW.EXE (CodeView for Windows) and a collection of dynamic-link libraries (DLLs). Each DLL implements an aspect of the debugging process.

The following table summarizes CodeView's component DLLs:

<b>TOOLS.INI Entry</b>	<b>Component</b>	<b>Required</b>	<b>Example</b>
<b>Eval</b>	Expression evaluator	Required	C or C++
<b>Model</b>	Additional nonnative execution model	Optional	P-code
<b>Native</b>	Native execution model	Required	MS-DOS or Windows
<b>Symbolhandler</b>	Symbol handler	Required	MS-DOS or Windows
<b>Transport</b>	Transport layer	Required	Local or remote

This architecture allows for the implementation of such improbable debugging configurations as a Windows operating system-hosted debugger that debugs interpreted Macintosh programs across a network. The existing CVW.EXE could be used with new transport, symbol handling, and execution model DLLs. Instead of creating completely different programs for each combination of host and target, all that is needed is the appropriate set of DLLs.

## CodeView Files

CodeView for Windows and CodeView for MS-DOS use several additional files. One of these is the executable program file that you are debugging. CodeView requires one executable (.EXE) file to load for debugging.

### *program.EXE*

An .EXE-format program to debug. CodeView assumes the .EXE extension when you specify the program to load for debugging.

### *source.ext*

A program source file. Your program may consist of more than one source file. When CodeView needs to load a source file for a module at startup or when you step into a new module, it searches directories in the following order:

1. The "compiled directory." This is the source-file path specified when you invoke the compiler.
2. The directory where the program is located.

If CodeView cannot find the source file in one of these directories, it prompts you for a directory. You can enter a new directory or press ENTER to indicate that you do not want a source file to be loaded for the module. If you do not specify a source file, you can debug only in Assembly mode.

### CV.HLP ADVISOR.HLP

Help files for CodeView and the Microsoft Advisor. These two files are the minimum set of files required to use Help during a CodeView session. They must be in a directory listed in the HELPFILES environment variable or in the **Helpfiles** entry of TOOLS.INI. Depending on what programming environment you work in, you may also want to use the various programming language and p-code help files.

### TOOLS.INI

Specifies paths for CodeView .DLL files and other files that CodeView uses. The MASM SETUP program creates the file TOOLS.PRE in the directory specified in your INIT environment variable.

If CodeView cannot find the modules it needs in its own directory, it looks for entries in TOOLS.INI that specify paths for the modules it needs. You can include other settings for CodeView in TOOLS.INI.

### TOOLHELP.DLL

System support .DLL for CVW.

Remote debugging requires additional files and a different configuration. The files and configuration required for remote debugging are described in Chapter 10, “Special Topics.”

## Configuring CodeView with TOOLS.INI

You can configure CodeView and other Microsoft tools including the Microsoft Programmer’s WorkBench (PWB) and NMAKE by specifying entries in the TOOLS.INI file. You must have separate sections in TOOLS.INI for each tool. TOOLS.INI sections begin with a “tag”—a line containing the base name of the executable file enclosed in brackets ([ ]). The tag must appear in column one. The CV and CVW section tags look like this:

```
[CV]
;           MS-DOS CodeView entries
. . .
[CVW]
;           Windows operating system CodeView entries
. . .
```

In the TOOLS.INI file, a line beginning with a semicolon (;) is a comment.

CodeView looks for certain entries following the tag. Each entry may be preceded by any number of spaces, but the entire entry must fit on one line. You may want to indent each entry for readability.

## CodeView TOOLS.INI Entries

You may want to specify or change entries in TOOLS.INI to customize CodeView. Table 8.1 summarizes the TOOLS.INI entries.

**Table 8.1 CodeView TOOLS.INI Entries**

Entry	Description
<b>Autostart</b>	Commands to execute on startup
<b>Color</b>	Screen colors
<b>Cvdlpath</b>	Path to CodeView .DLL files
<b>Eval</b>	Expression evaluator
<b>Helpbuffer</b>	Size of help buffer
<b>Helpfiles</b>	List of help files
<b>Model</b>	Additional execution model (such as p-code)
<b>Native</b>	Native execution model
<b>Printfile</b>	Default name for print command or file
<b>Statefileread</b>	Read or ignore CURRENT.STS state file
<b>Symbolhandler</b>	Symbol handler
<b>Transport</b>	Transport layer

### Autostart

The **Autostart** entry specifies a list of Command-window commands that CodeView executes on startup.

#### Syntax

**Autostart:***command*[[;*command*]]...

*command*

A command for CodeView to execute at startup. Separate multiple commands with a semicolon (;).

#### Example

The following entry automatically executes the program's run-time startup code. It specifies that CodeView always starts with the Screen Swap option off and the Trace Speed option set to fast.

```
Autostart:OF-;TF;Gmain
```

### Color

The **Color** entry is retained only for compatibility with previous versions of CodeView. You should set screen colors with the Colors command on the Options menu.



## Cvdlldllpath

The **Cvdlldllpath** entry specifies the default path for CodeView's dynamic-link libraries (DLLs). CodeView searches this path when it cannot find its DLLs in CodeView's directory or along the PATH environment variable. This entry is recommended.

### Syntax

**Cvdlldllpath:***path*

*path*

The path to the CodeView .DLL files.

## Eval

The **Eval** entry specifies an expression evaluator. The expression evaluator looks up symbols, parses, and evaluates expressions that you enter as arguments to CodeView commands. If there is no **Eval** entry in TOOLS.INI, CodeView loads the C++ expression evaluator by default. CodeView uses the specified expression evaluator when you are debugging modules with source files ending in the specified extensions.

### Syntax

**Eval:***[[path\]]EEhost evaluator.DLL extension...*

*path*

The path to the specified expression evaluator.

*host*

The host environment.

Specifier	Operating Environment
D1	MS-DOS
W0	Windows

*evaluator*

The source language expression evaluator.

Specifier	Source Language
CAN	C or MASM
CXX	C, C++, or MASM

*extension*

A source-file extension. CodeView uses the specified expression evaluator when it loads a source file with the given extension. You can list any number of extensions.

**Example**

The following example loads both the C and C++ expression evaluators for the MS-DOS CodeView:

```
Eval:C:\C700\DLL\EED1CAN.DLL .C .ABC .ASM .H
Eval:C:\C700\DLL\EED1CXX.DLL .CPP .CXX .XYZ .HXX
```

With the entries in this example, when you trace into a module whose source file has the extension `.C`, `.ABC`, or `.ASM`, CodeView uses the C expression evaluator. When you trace into a source file with a `.CXX`, `.CPP`, or `.XYZ` extension, CodeView switches to the C++ expression evaluator.

---

**Note** The C++ expression evaluator is the only expression evaluator provided with MASM 6.10. For most MASM, C, and C++ programs the C++ expression evaluator is sufficient.

---

You can load expression evaluators after CodeView has started by using the Load command from the Run menu. You can override CodeView's automatic choice of expression evaluator by using the Language command on the Options menu or the **USE** command in the Command window.

For more information about choosing an appropriate expression evaluator and how to use expressions in CodeView, see Chapter 11, "Using Expressions in CodeView."

## Helpbuffer

The **Helpbuffer** entry specifies the size of the buffer CodeView uses to decompress help files. You can set **Helpbuffer** to 0 to disable Help and maximize the amount of memory available for debugging. Otherwise, specify a value between 1 and 256.

**Syntax**

**Helpbuffer:***size*

*size*

The number of kilobytes (K) of memory to use for decompressing help files. The default help buffer size is 24K. Specify 0 to disable help.

The following table shows values you can specify and the actual size of the buffer that is allocated:

Value Specified	Help Buffer Size
1–24	24K
25–128	128K
129–256	256K

The smallest buffer size is 24K, and the largest is 256K.

## Helpfiles

The **Helpfiles** entry lists help files for CodeView to load. These files are loaded before any files listed in the HELPFILES environment variable.

### Syntax

**Helpfiles:***file*[[;*file*]]...

#### *file*

A directory or help file. If you list a directory, CodeView loads all files with the .HLP extension in that directory. Separate multiple files or directories with a semicolon (;).

## Model

The **Model** entry specifies an additional execution model that CodeView uses when you are debugging nonnative code such as p-code. The execution model handles tasks specific to the type of executable code that you are debugging.

### Syntax

**Model:**[[*path*\]]*NMhost model.DLL*

#### *path*

The path to the specified file.

#### *host*

The host environment must be one of the following:

Specifier	Operating Environment
D1	MS-DOS
W0	Windows

#### *model*

A nonnative execution model. The p-code execution model (PCD) is required if you plan to debug p-code.

### Example

```
Model:NMD1PCD.DLL
```

## Native

The **Native** entry specifies the native execution model. This DLL handles tasks that are specific to the machine and operating system on which you are running (the host) and specific to the native code (the target).

### Syntax

**Native:**[[*path*\]]*EMhost target.DLL*

#### *path*

The path to the specified native execution model.

*host*

The host environment must be one of the following:

Specifier	Operating Environment
-----------	-----------------------

D1	MS-DOS
----	--------

W0	Windows
----	---------

*target*

The target environment must be one of the following:

Specifier	Operating Environment
-----------	-----------------------

D1	MS-DOS
----	--------

W0	Windows
----	---------

## Printfile

The **Printfile** entry lists the default device name or filename used by the Print command on the File menu. This can be a printer port (for example, LPT1 or COM2) or an output file. If **Printfile** is omitted, CodeView prints to a file named CODEVIEW.LST in the current directory. This entry is ignored by CVW, which does not have the Print command.

### Syntax

**Printfile:***path*

*path*

The path to the specified output file or the name of a device.

## Statefileread

The **Statefileread** entry tells CodeView to read or ignore the CodeView state file (CURRENT.STS) on startup. You can toggle this setting from the command line using the /TSF (Toggle State File) option. These options have no effect on writing CURRENT.STS. CodeView always saves its state on exit.

### Syntax

**Statefileread:***[[y | n]]*

*y* (yes)

CodeView reads CURRENT.STS on startup.

*n* (no)

CodeView ignores CURRENT.STS on startup.

## Symbolhandler

The **Symbolhandler** entry specifies a symbol handler. The symbol handler manages the CodeView symbol and type information.

**Syntax****Symbolhandler:**[[*path*\]]**SH***host*.**DLL***path*

The path to the symbol handler.

*host*

The host environment must be one of the following:

Specifier	Operating Environment
-----------	-----------------------

D1	MS-DOS
----	--------

W0	Windows
----	---------

**Transport**

The **Transport** entry specifies a transport layer. A transport layer provides the data link for communication between the host and target during debugging.

**Syntax****Transport:***path*\**TL***host transport*.**DLL** [[COM{ 1|2}:[[*rate*]]]]*path*

The path to the specified transport layer.

*host*

The host environment must be one of the following:

Specifier	Operating Environment
-----------	-----------------------

D1	MS-DOS
----	--------

W0	Windows
----	---------

*transport*

Specifies a transport layer.

Specifier	Transport Layer
-----------	-----------------

LOC	Local transport layer
-----	-----------------------

COM	Serial remote transport layer
-----	-------------------------------

The optional [[COM{ 1|2}:[[*rate*]]]] specifies a communications port and baud rate for remote debugging. No space is allowed between COM and the port number (1 or 2). The default port is COM1. The <rate> can be any number from 50 through 9600. The default rate is 9600.

You specify the local transport layer (LOC) when the debugger and the program you are debugging are running on the same machine. With the appropriate transport layer, CodeView can support remote debugging across serial lines or networks. For more information on remote debugging, see Chapter 10.

The following example specifies the transport layer for debugging a program that is running on the same machine.

**Example**

```
Transport:C:\C700\DLL\TLW0LOC.DLL
```

## Memory Management and CodeView

CodeView for MS-DOS (CV) requires at least 2 megabytes of memory. The memory must be managed by a Virtual Control Program Interface (VCPI) server, DOS Protected-Mode Interface (DPMI) server, or extended memory (XMS) manager. These drivers manage memory at addresses above 1 megabyte on an 80286, 80386, or 80486 machine. CodeView loads itself and the debugging information for the program into high memory. In this way, CodeView uses only approximately 17K of conventional MS-DOS memory.

CodeView can use the following memory managers:

- ◆ A VCPI server such as EMM386.EXE or EMM386.SYS. With a VCPI server, your program is also able to use EMS memory. To use this memory manager you must have a command in your CONFIG.SYS file such as:

```
DEVICE=C:\DOS\EMM386.EXE ram
```

- ◆ A DPMI server such as 386max.
- ◆ An Extended Memory Standard (XMS) driver such as HIMEM.SYS. To use this memory manager you must have a command in your CONFIG.SYS file such as:

```
DEVICE=C:\DOS\HIMEM.SYS
```

For more information about using memory managers, see your memory manager's documentation. When you make new entries in your CONFIG.SYS file, remember to reboot your system so that your changes take effect.

## The CodeView Command Line

You can specify CV or CVW options when you start them from the command line. You can also specify commands from within the CodeView environment to modify these startup arguments.

**Syntax**

```
CV[[W]] [[options]] [[program [[arguments]] ]]  
CV[[W]] @file [[program [[arguments]] ]]
```

**W**

Indicates the Windows operating system version of CodeView.

*options*

One or more options. The CodeView options are described in the “Command-Line Options” section on page 310.

*program*

Program to be debugged. Specifies the name of an executable file to be loaded by the debugger. If you specify *program* as a filename with no extension, CodeView searches for a file with the extension .EXE. If you do not specify a program, CodeView starts up and displays the Load dialog box where you can specify a program and its command-line arguments.

*arguments*

The program’s command-line arguments. All remaining text on the CodeView command line is passed to the program you are debugging as its command line. If the program you are debugging does not accept command-line arguments, you do not need to specify any. Once you’ve started debugging, you can change the program’s command-line arguments.

*@file*

File of command-line arguments. You can also specify arguments in a text file. The file contains a list of arguments, one per line. An argument file lets you specify a large number of arguments without exceeding the operating-system limit on the length of a command line. This is especially useful when starting a session that uses many DLLs.

After CodeView loads its DLLs, processes the debugging information, and loads the source file, the CodeView display appears. If you do not specify a program to debug or CodeView cannot find all of its required DLLs, CodeView prompts for the necessary files.

After starting up, CodeView is at the beginning of the program startup code, and you are ready to start debugging. At this point, you can enter an execution command (such as Trace or Program Step) to execute through the startup code to the beginning of your program.

## Leaving CodeView

To exit CodeView at any time, choose the Exit command from the File menu. You can also press ALT+F4, or type Q (for “Quit”) in the Command window.

At this point, you may want to skip ahead to the next chapter, “The CodeView Environment” for information on CodeView’s menus and windows. The rest of this chapter describes each command-line option in detail, then continues with a description of how PWB and CodeView use the CURRENT.STS file.

## Command-Line Options

CV and CVW accept some of the same options for debugging. Table 8.2 summarizes the CodeView command-line options.

**Table 8.2 CodeView Command-Line Options**

Option	CV	CVW	Description
<i>/2</i>	Yes	Yes	Use two displays
<i>/8</i>	No	Yes	Use 8514 and VGA displays
<i>/25, /43, /50</i>	Yes	Yes	Set 25-line, 43-line, or 50-line mode
<i>/B</i>	Yes	Yes	Use black-and-white display
<i>/Ccommands</i>	Yes	Yes	Execute commands
<i>/F</i>	Yes	No	Flip video pages
<i>/G</i>	Yes	Yes	Control snow on CGA displays
<i>/I[0   1]</i>	Yes	Yes	Trap NMIs and 8259 interrupts
<i>/Ldll</i>	No	Yes	Load DLL or application symbols
<i>/M</i>	Yes	Yes	Disable mouse
<i>/N[0   1]</i>	Yes	Yes	Trap nonmaskable interrupts
<i>/S</i>	Yes	No	Swap video buffers
<i>/TSF</i>	Yes	Yes	Read or ignore state file
<i>/X</i>	No	Yes	Set starting X coordinate (pixels)
<i>/Y</i>	No	Yes	Set starting Y coordinate (pixels)

The remainder of this section describes each option in detail.

### Use Two Displays (CV, CVW)

#### Option

#### */2*

The */2* option permits the use of two monitors. The program display appears on the default monitor, while CodeView displays on the secondary monitor. You must have two monitors and two adapters to use the */2* option. The secondary display must be a monochrome adapter.

If you are debugging a Windows-based application and have an IBM PS/2 with an 8514 primary display and a Video Graphics Adapter (VGA) secondary display, use the */8* option.



## Option

## Use 8514 and VGA Displays (CVW)

**/8**

If your system is an IBM PS/2, you can configure it with an 8514 as the primary display and a VGA as the secondary display. To use this configuration, specify the /8 (8514) option on the CVW command line.

If your VGA monitor is monochrome, it is recommended to use the /B (black-and-white) option. The 8514 serves as the Windows operating system screen and the VGA as the debugging screen.

By default, the debugging screen operates in 50-line mode in this configuration. If you specify the /8 option, you can specify /25 or /43 for 25-line or 43-line mode on the debugging screen.

---

---

**Warning** Results are unpredictable if you attempt to run non-Windows-based applications or the MS-DOS shell while you are running CVW with the /8 option.

---

---

## Options

## Set Line-Display Mode (CV, CVW)

**/25**

**/43**

**/50**

If you have the appropriate display adapter and monitor, you can display 25, 43, or 50 lines when you are running CV, and 25 or 50 lines when you are running CVW. The mode you specify is saved in the CURRENT.STS file so that it is still in effect the next time you run CodeView.

CVW.EXE supports 25, 43 and 50 lines on VGA monitors. It does not support 50-line mode on EGA monitors. If you specify a mode that is not supported by your adapter and your monitor, CodeView displays 25 lines.

To display 43 or 50 lines on a screen, you must use the OEM fonts supplied with CodeView. There are two OEM files: OEM08.FON for 50-line mode, and OEM10.FON for 43-line mode. To use these fonts, change the OEMFONTS.FON entry in your SYSTEM.INI file. For example, to use 50-line mode, change:

```
OEMFONTS . FON=VGAOEM . FON
```

to:

```
OEMFONTS . FON=C : \MASM\BIN\OEM08 . FON
```

## Use Black-and-White Display (CV, CVW)

### Option

**/B**

When you start CodeView, it checks the kind of display adapter that is installed in your computer. If the debugger detects a monochrome adapter, it displays in black and white; if it finds a color adapter, it displays in color. The /B option tells CodeView to display in black and white even if it detects a color adapter.

If you use a monochrome display or laptop computer that simulates a color display, you may want to disable color. These displays may be difficult to read with CodeView's color display.

You can also customize CodeView's colors by choosing the Colors command from the Options menu. For more information, see "Colors" on page 345.

## Execute Commands (CV, CVW)

### Option

**/C*commands***

You type commands in the CodeView Command window. You can also specify Command-window commands when you start CodeView. The /C option allows you to specify one or more CodeView Command-window commands to be executed upon startup. If you specify more than one command, you must separate each one with a semicolon (;).

If the commands contain spaces or redirection symbols (< or >), enclose the entire option in double quotation marks ("). Otherwise, the debugger interprets each argument as a separate CodeView command-line argument rather than as a Command-window command.

For complete information on CodeView Command-window commands, see Chapter 12, "CodeView Reference."

### Examples

The following example loads CV with `CALCPR` as the executable file and `/p TST.DAT` as the program's command line:

```
CV /CGmain CALCPR /p TST.DAT
```

Upon startup, CV executes the high-level language startup code with the command `Gmain`. Since no space is required between the command (`G`) and its argument (`main`), there is no need to enclose the option in double quotation marks.

The next example loads CV with `CALCPR` as the executable file and `/p TST.DAT` as the program's command line. It starts CodeView with a long list of startup commands.

```
CV "/C VS &G signal_lpd;MDA print_buffer L 20" CALCPR /p TST.DAT
```

CodeView starts with the Source window displaying in Mixed mode (`VS &`). Then it executes up to the function `signal_lpd` with the command `G signal_lpd`. Next, it dumps 20 characters starting at the address of `print_buffer` with the command `MDA print_buffer L 20`. Since some of the commands use spaces, the entire `/C` option is enclosed in quotation marks.

In this example, the command directs CV to take Command-window input from the file `SCRIPT.TXT` rather than from the keyboard:

```
CV "/C<SCRIPT.TXT" CALCPR TST.DAT
```

Although the option does not include any spaces, you must enclose it in quotation marks so that the less-than symbol (`<`) is read by CodeView rather than by the operating-system command processor.

## Set Screen-Exchange Method (CV)

### Options

`/F`  
`/S`

CodeView allows you to move between the output screen, which contains your program display output, and the CodeView screen, which contains the debugging display. In MS-DOS, CodeView can perform this screen exchange in two ways: screen flipping or screen swapping. The `/F` (flipping) and `/S` (swapping) options allow you to choose the method from the command line. These two methods are:

#### Flipping

Flipping is the default for a computer with a graphics adapter. CodeView uses the graphic adapter's video-display pages to store each screen of text. Flipping is faster than swapping and uses less memory, but it cannot be used with a monochrome adapter or to debug programs that use graphic video modes or the video-display pages. CodeView ignores the `/F` option if you have a monochrome adapter.

#### Swapping

Swapping is the default for computers with monochrome adapters. It has none of the limitations of flipping, but it is slower than flipping and requires more memory. To swap screens, CodeView creates a buffer in memory and uses it to store the screen that is not displayed. When you request the other screen, CodeView swaps the screen in the display buffer for the one in the storage buffer. When you use screen swapping, the buffer is 16K bytes for all adapters. The amount of memory CodeView uses is increased by the size of the buffer.

## Suppress Snow (CV, CVW)

### Option

*/G*

The */G* option suppresses snow that can appear on some CGA displays. Use this option if your CodeView display is unreadable because of snow.

## Specify Interrupt Trapping (CV, CVW)

### Options

*/I*[[0 | 1]]

*/N*[[0 | 1]]

The */I* option tells CV whether to handle nonmaskable-interrupt (NMI) and 8259-interrupt trapping. The */N* option controls only CodeView's handling of NMIs and does not affect handling of interrupts generated by the 8259 chip. The following table summarizes the options and their effects:

Option	Effect
<i>/I0</i>	Trap NMIs and 8259 interrupts
<i>/I1, /I</i>	Do not trap NMIs or 8259 interrupts
<i>/N0</i>	Trap NMIs
<i>/N1, /N</i>	Do not trap NMIs

You may need to force CodeView to trap interrupts with */I0* on computers that CodeView does not recognize as IBM compatible. Using */I0* enables the CTRL+C and CTRL+BREAK interrupts on such computers.

## Load Other Files (CVW)

### Option

*/Ldll*

*/Lexe*

To load symbolic information from a dynamic-link library (DLL) or from another application, use the */L* option when you start CodeView. Specify */L* for each DLL or application that you want to debug.

When you place a module in a DLL, neither code nor debugging information for that module is stored in an application executable (.EXE) file. Instead, the code and symbols are stored in the library and are not linked to the main program until run time. The same is true for symbols in another application running within Windows. Thus, CVW needs to search the DLL or other application for symbolic information. Because the debugger does not automatically know which libraries to look for, use the */L* option to preload the symbolic information.

**Example**

The following command starts CodeView for Windows:

```
CVW /LPRIORITY.DLL /LCAPPARSE.DLL PRINTSYS
```

CVW is used to debug the program PRINTSYS.EXE. CVW loads symbolic information for the dynamic-link libraries PRIORITY.DLL and CAPPARSE.DLL, as well as the file PRINTSYS.EXE.

**Disable Mouse (CV, CVW)****Option**

**/M**

If you have a mouse installed on your system, you can tell CodeView to ignore it by using the /M option. You may need to use this option if you are debugging a program that uses the mouse and there is a usage conflict between the program and CodeView.

**Nonmaskable-Interrupt Trapping (CV, CVW)****Option**

**/N**

For information on the /N option, see “Specify Interrupt Trapping” on page 314.

**Set Screen Swapping (CV)****Option**

**/S**

The /S option sets the CodeView screen-exchange method to swapping. For complete information on CodeView screen-exchange methods, see “Set Screen-Exchange Method” on page 313.

**Toggle State-File Reading****Option**

**/TSF**

The Toggle State File (/TSF) option either reads or ignores CodeView’s state file and color files, depending on the **Statefileread** entry in the CodeView sections of TOOLS.INI. The /TSF option reverses the effect of the **Statefileread** entry. The **Statefileread** entry is set to yes by default.

These options have no effect on writing the files. CodeView always saves its state on exit.

The effect of different combinations of **Statefileread** and **/TSF** are summarized in the following table:

<b>/TSF</b>	<b>Statefileread</b>	<b>CodeView Result</b>
Specified	y (or omitted)	Do not read files
Specified	n	Read files
Not specified	y (or omitted)	Read files
Not specified	n	Do not read files

The state file is **CURRENT.STS**. The color files are **CLRFILE.CV4** for CV and **CLRFILE.CVW** for CVW.

## Set Startup X and Y Coordinates

### Options

**/X, /Y**

The window CodeView uses within Windows cannot be moved or sized while Windows is running. You can specify the position of the CodeView window with the **/X** and **/Y** options. In the Command Line field of the Program Item Properties dialog box, enter

```
C:\MASM\BIN\CVW.EXE /X:X /Y:Y
```

where X and Y are the pixel coordinates for the upper lefthand corner of the CodeView session window. (The location for your CVW.EXE file may be different.) Note that this still does not allow the CodeView window to be moved to another location on the Program Manager workspace. For more information on specifying command-line options with Windows operating system applications, see your Windows *User's Guide*.

## The CURRENT.STS State File

CodeView and PWB save settings and state information in the **CURRENT.STS** file. The file contains information about the current state of the two environments. When you restart CodeView or PWB, they read **CURRENT.STS** and restore their previous state. CodeView uses additional files to save your most recent color settings. These files are **CLRFILE.CV4** for CV and **CLRFILE.CVW** for CVW.

CodeView and PWB search for these files in the directory that the **INIT** environment variable specifies. If no **INIT** environment variable exists, CodeView and PWB search the current directory. If no state file is found, new **CURRENT.STS** and **CLRFILE.CV4** or **CLRFILE.CVW** files are created in the **INIT** directory or the current directory if no **INIT** variable is set.

Information about CodeView stored in CURRENT.STS includes:

- ◆ Window layout
- ◆ Breakpoints
- ◆ Watch expressions
- ◆ Source, Local, and Memory display options
- ◆ Global CodeView options such as case sensitivity, screen exchange method, radix, and expression evaluator

You can set CodeView options in TOOLS.INI or on the command line and then modify them during a session. They are saved in CURRENT.STS when you exit CodeView. During each CodeView session, these features are set in the following order:

1. From TOOLS.INI
2. From the CodeView command line
3. From CURRENT.STS
4. During the debugging session

The following items are not saved between sessions:

- ◆ The current location (CS:IP).
- ◆ The expansion state of watch expressions.  
All watch expressions and their format specifiers are restored, but they appear in their contracted state.
- ◆ Absolute-address breakpoints.  
Breakpoints set at an absolute *segment:offset* address are not saved. CodeView saves breakpoints only at specific line numbers or symbols.
- ◆ Memory window addresses.  
Each memory window is restored with its display type and options, but CodeView does not save the starting address. Instead, Memory windows show the start of the data segment (address DS:00).





---

## CHAPTER 9

# The CodeView Environment

CodeView provides a powerful environment in which to debug programs and dynamic-link libraries (DLLs). Its rich set of commands helps you track program execution and changing data values.

In CodeView you can “point-and-click” your source code to start and stop execution or modify bytes in memory. You can also use more traditional keyboard commands. You can use function keys to execute common commands, such as tracing and stepping through a program. When you quit CodeView, it remembers your breakpoints, window arrangement, watch expressions, and option settings.

This chapter describes the CodeView display, shows you how to use the menu commands, and how to interact with the different types of windows.

## The CodeView Display

The CodeView screen is divided into three parts:

- ◆ The menu bar across the top of the screen
- ◆ The window area between the menu bar and status bar
- ◆ The removable status bar across the bottom of the screen

Figure 9.1 shows a typical CodeView screen with several open windows. The figure shows selected elements of the display, which are described in the sections that follow.

```

File Edit Search Run Data Options Calls Windows Help
[1] local
[BP+0004]+char *name = 0x4508:0x11C6 "extra.txt"
[BP-0002] short nMax = 16112
[BP-0004]+_iobuf near *File = 0x4508:0x0368
[BP-0006] short InWord = 0
constant short TRUE = 1
cons=[3] source1 CS:IP COUNT.C
75: }
76:
77: InWord = FALSE;
78: // Read file buffers
79: while( nMax = fread( Buffer, 1, BUFSIZE, File ) )
80: InWord = CountWords( InWord, nMax );
81:
82: // Calculate and print the results.
83: printf( "\n\nFile statistics for %s\n\n", name );
[17]register
EAX = 0000368
EBX = 00000408
ECX = 00000011
EDX = 000011C6
EFL = 00003202
NU UP EI PL
NZ NA PO NC
[19] command
1) E "{,COUNT.C,count.EXE} .56"
2) E "{,COUNTBUF.C,count.EXE} .16"
>
<F8=Trace> <F10=Step> <F5=Go> <F3=Src1 Fmt> DEC

```

Figure 9.1 CodeView Display

## The Menu Bar

The menu bar displays the names of the CodeView menus. To open a menu, use one of the following methods:

- ◆ Click a menu title with the mouse.
- ◆ Press ALT plus the menu title's highlighted letter.
- ◆ Press and release ALT, use the arrow keys to select a menu, and then press DOWN ARROW or ENTER to open it.

Each command in a menu has a highlighted letter. To choose that command, press the highlighted letter. Many commands also list a shortcut key that you can press at any time instead of opening a menu and choosing a command.

A command that does not apply to a particular situation is dimmed on the menu. When you press the corresponding shortcut key, no action is performed.

## The Window Area

Most of your debugging takes place in the window area, where you can open, close, move, size, and overlap the various types of CodeView windows. Although each

window serves a different function for debugging, the windows have a number of common features. The Close, Maximize, Restore, and Minimize boxes work in the same way as they do in PWB. The scroll bars also work the same as in PWB. For information on the window border controls, see Chapter 4, “User Interface Details.”

Only one window can be active at a time. You always use the currently active window, which appears with a highlighted border and a shadow on the screen. The text cursor always appears in the active window.

## The Status Bar

The status bar contains information about the active window. It usually includes a row of buttons you can click to execute commands. You can also use the shortcut keys shown on the buttons.

To remove the status bar and gain an extra line for the window area, choose Status Bar from the Options menu, or type the OA- command in the Command window. To restore the status bar, choose Status Bar from the Options menu, or type the OA+ command in the Command window. For more information on this command, see the “Options” command on page 422.

## CodeView Windows

CodeView windows organize and display information about your program. This section describes each CodeView window, the information you can display, and how you can change information and enter commands in the Command window. It also explains how to move among the windows and manipulate them.

## How to Use CodeView Windows

Each CodeView window has a different function and operates independently of the others. Only one window can be active at a time. Commands you choose from the menus or by using shortcut keys affect the active window. The following list briefly describes each window’s function:

### Source

Displays the source or assembly code for the program you are debugging. You can open a second Source window to view an include file or any ASCII text file.

### Command

Accepts debugging commands from the keyboard. CodeView displays the results, including error messages, in the Command window. When you enter a command in a dialog box, CodeView displays any resulting errors in a pop-up window.

### Watch

Displays the values of variables and expressions you select. You can modify the value of watched variables, browse the contents of structures and arrays, and follow pointers through memory.

### Local

Lists the values of all variables local to the current scope. You can set Local window options to show other scopes. You can modify the values of variables displayed in the Local window.

### Memory

Displays the contents of memory. You can open a second Memory window to view a different section of memory. You can set Memory window options to select the format and address of displayed memory. You can directly change the displayed memory by typing in the Memory window.

### Register

Displays the contents of the machine's registers and flags. You can directly edit the values in the registers, and you can toggle flags with a single keystroke or mouse click.

### 8087

Displays the registers of the hardware math coprocessor or the software emulator.

### Help

Displays the Microsoft Advisor Help system.

The first time you run CodeView, it displays three windows. The Local window is at the top, the Source window fills the middle of the screen, and the Command window is at the bottom. The Local window is empty until you trace into the main part of the program.

You can open or close any CodeView window. However, at least one Source window must remain open. When you exit CodeView, it records which windows are open and how they are positioned, along with their display options. These settings become the default the next time you run CodeView.

To open a window, choose a window from the Windows menu. Some operations, such as setting a watch expression or requesting help, open the appropriate window automatically.

You can change how CodeView displays information in the Source, Memory, and Local windows. Choose the appropriate window options command from the Options menu. When the cursor is in one of these windows, you can press CTRL+O to display that window's options dialog box.

CodeView automatically updates the windows as you debug your program. To interact with a particular window (such as entering a command or modifying a

variable), you must select it. The selected window is the “active” window. The active window is marked in the following ways:

- ◆ The window’s frame is highlighted.
- ◆ The window casts a shadow over other windows.
- ◆ The cursor appears in the window.
- ◆ The horizontal and vertical scroll bars move to the window.

To make a window active, click anywhere in the window or in the window frame. You can also press F6 or SHIFT+F6 to cycle through the open windows, making each one active in turn. You can also choose a window from the Windows menu or press ALT plus a window number. In addition, some CodeView commands make a certain window active.

## Moving Around in CodeView Windows

To move the cursor to a specific window location, click that location. You can also use the keyboard to move the cursor as shown in Table 9.1.

**Table 9.1 Moving Around with the Keyboard**

Action	Keyboard
Move cursor up, down, left, and right	UP ARROW, DOWN ARROW, LEFT ARROW, RIGHT ARROW
Move cursor left and right by words	CTRL+LEFT, CTRL+RIGHT
Move cursor to beginning of line	HOME
Move cursor to end of line	END
Page up and down	PAGE UP, PAGE DOWN
Page left and right	CTRL+PAGE UP, CTRL+PAGE DOWN
Move cursor to beginning of window	CTRL+HOME
Move cursor to end of window	CTRL+END
Move to next window	F6
Move to previous window	SHIFT+F6
Restore window	CTRL+F5
Move window	CTRL+F7
Size window	CTRL+F8
Minimize window	CTRL+F9
Maximize window	CTRL+F10
Close window	CTRL+F4
Tile windows	SHIFT+F5
Arrange windows	ALT+F5

## The Source Windows

The Source windows display the source code. You can open a second Source window to view other source files, header files, the same source file at a different location, or any ASCII text file. To open a Source window, use one of the following methods:

- ◆ From the Windows menu, choose Source 1 or Source 2.
- ◆ In the Command window, type the View Source (**VS**) command.
- ◆ Press ALT+3 to open Source window 1.
- ◆ Press ALT+4 to open Source window 2.

You cannot edit source code in CodeView, but you can temporarily modify the machine code in memory using the Assemble (**A**) command. For more information on the Assemble command, see page 400.

Source windows can display three different views of your program code in three different modes:

- ◆ Source mode shows your source file with numbered lines.
- ◆ Assembly mode shows a disassembly of your program's machine code.
- ◆ Mixed mode shows each numbered source line followed by a disassembly of the machine code for each line.

---

**Note** When you are debugging p-code while Native mode is off, CodeView displays p-code instructions rather than disassembled machine instructions. See the "Options" command on page 422. For more information on p-code, see "Debugging P-code" on page 363.

---

CodeView automatically switches to Assembly mode when you trace into routines for which no source is available, such as library or system code. The debugger switches back to the original display mode when you continue tracing into code for which source code is available.

For more information on setting display modes, see the "View Source" command on page 433. For detailed information about the Source window display options, see page 343.

## The Watch Window

The Watch window displays the value of program variables or the value of expressions you specify in a high-level language. For each expression or variable, you can change the format of the data that is displayed. You can expand aggregate variables, such as structures and arrays, to show all the elements of an aggregate

and contract them to save space in the Watch window. You can follow chains of pointers to display and help debug more complex structures, such as linked lists or binary trees.

To open a Watch window, use one of the following methods:

- ◆ From the Windows menu, choose Watch.
- ◆ In the Command window, type the Add Watch (**W?**) command followed by the variable or expression name.
- ◆ Press ALT+2.

To add expressions to the Watch window, use the Add Watch command from the Data menu or the Quick Watch dialog box (SHIFT+F9). You can also add watch expressions using the Add Watch (**W?**) and Quick Watch (**??**) commands.

---

**Note** Do not edit a string in the Watch window.

---

To change the value of any variable displayed in the Watch window, move the cursor to the value, delete the old value, and type the new value. To change the format in which a variable is displayed or to specify a new format, move the cursor to the end of the variable name and type a new format specifier.

To toggle between insert and overtype modes, press the INS key.

## Using the Watch Window to View Multi-Level Arrays

You can use the watch window to view the changing values of a structure or array as you step or trace through your program:

1. Open the Watch Window.
2. Add the structure whose elements you want to track to the Watch window with the Add Watch command from the Data menu, or by using the Quick Watch dialog box (SHIFT+F9). The structure name will be added to the Watch Window.
3. Using the mouse, double-click anywhere on the structure name in the Watch Window to expand it one level. Double-click again on any subsequent levels until the structure is open to the level you want to watch.
4. Step or Trace through the code using F8 or F10 keys. The structure elements will update with each step.

For information on expanding and contracting aggregate types and following pointers, see the “Quick Watch” command on page 453. For detailed information on specifying and using watch expressions, see the “Codeview Expression Reference” on page 393 and Chapter 11, “Using Expressions in CodeView.”

## The Command Window

You type CodeView commands in the Command window to execute code, set breakpoints, and perform other debugging tasks. You can use the menus, mouse, and keyboard for many debugging tasks, but you can use some CodeView commands only in the Command window.

When you first start the debugger, the Command window is active, and the cursor is at the CodeView prompt (>). To return to the Command window after you make another window active, click the command window, or press ALT+9.

Using the Command window is similar to using an operating-system prompt, except that you can scroll back to view previous results and edit or reuse previous commands or parts of commands.

### How to Enter Commands and Arguments

You enter commands in the Command window at the CodeView prompt when the Command window is active. Type the command followed by any arguments and press ENTER. Some commands, such as the Assemble (A) command, prompt for an indefinite series of arguments until you enter an empty response. CodeView may display errors, warnings, or other messages in response to commands you enter in the Command window.

If a Source window is active and the Command window is open, you can still type Command-window commands. When you begin typing, the cursor moves to the Command window and remains there until you press ENTER. The cursor returns to the Source window, and CodeView executes the command. If you have begun typing but do not want to execute a command, press ESC to clear the text and place the cursor at the prompt. After you press ESC, the Command window becomes active.

### Command Format

The format for CodeView commands is as follows:

*command* [[*arguments*]] [[;*command2*]]

The *command* is the command name, and *arguments* are control options or expressions that represent values or addresses to be used by the command. The first argument can usually be placed immediately after *command* with no intervening spaces. Arguments may be separated by spaces or commas, depending on the command. For more information, see Chapter 12, “CodeView Reference.”

To specify additional commands on the same line, separate each command with a semicolon (;).



Commands are always one, two, or three characters long. They are not case sensitive, so you can use any combination of uppercase and lowercase letters. Arguments to commands may be case sensitive, depending on the command.

**Example**

The following example shows three commands separated by semicolons:

```
MDB 100 L 10 ; G .178 ; MDB 100 L 10
```

The first command (`MDB 100 L 10`) dumps 10 bytes of memory starting at address 100. The second command (`G .178`) executes the program up to line 178 in the current module. The third command is the same as the first and is used to see if the executed code changed memory.

**Example**

This example demonstrates the Comment (\*) command:

```
U extract_velocity ;* Unassemble at this routine
```

The first command is the Unassemble (**U**) command, given the argument `extract_velocity`. The next command is the Comment command. Comment commands are used throughout the CodeView examples in this book.

## How to Copy Text for Use with Commands

Copy and paste text instead of retyping.

Text that appears in any CodeView window can be copied and used in a command. For example, an address that is displayed in a Memory window or the Register window can be copied and used in a breakpoint command.

➔ **To copy and use text:**

1. Select the text with the mouse or the keyboard.

To select text with the mouse, move the mouse pointer to the beginning of the desired text, hold down the left mouse button, and drag the mouse. When you have selected the desired text, release the button.

To select text with the keyboard, move the cursor to the desired text, hold down the SHIFT key, and move the cursor with the ARROW keys.

2. Choose the Copy command from the Edit menu or press CTRL+INS.
3. Move the cursor to the location where you want to use the text and choose the Paste command from the Edit menu, or press SHIFT+INS.
4. Edit the command if desired, and press ENTER to execute the command.

Because all input to CodeView windows is line oriented, you cannot copy more than a single line. If you select more than a single line, the Copy command in the Edit menu is unavailable, and CTRL+INS has no effect. However, you can still select

more than one line for use with the Print command on the File menu. For more information about the Print command, see “Print” on page 333.

When editing a command, you can toggle between insert and overwrite modes by pressing the INS key.

## How to Use the Command Buffer

CodeView keeps the last several screens of commands and output in the Command window. You can scroll the Command window to view the commands you entered earlier in the session. This is particularly useful for viewing the output from commands, such as Memory Dump (**MD**) or Examine Symbols (**X**), whose output exceeds the size of the window.

The TAB key provides a convenient way to move among the previously entered commands. Press TAB to move the cursor to the beginning of the next command, and press SHIFT+TAB to move to the beginning of the previous command. If the cursor is at the beginning or the end of the command buffer, the cursor wraps around to the other end. To return to the current command prompt, you can press CTRL+END or press TAB repeatedly.

You can also reuse any command that appears in the Command window without copying and pasting. Move the cursor to the command or press TAB, edit the command if desired, and press ENTER to execute it. When you press ENTER, CodeView restores the original command, copies the new command to the current prompt, and executes the command. If you make a mistake while editing a command, press ESC to restore the line.

## The Local Window

The Local window shows all local variables in the current scope. The Local window is similar to the Watch window, except that the variables that are displayed change as the local scope changes. A variable in the Local window is always shown in its default type format. When you edit in the Local window, you can toggle between insert and overwrite modes by pressing the INS key.

You can expand and contract pointers, structures, and arrays the same way you do in the Watch window. You can also change the values of the variables as in the Watch window.

The keyboard shortcut to open or switch to the Local window is ALT+1.

You can see the local variables of each active routine in the stack by selecting the routine from the Calls menu. For more information on this feature, see “The Calls Menu” on page 346.

By default, the Local window shows the addresses of the local variables on the left side of the window. You can turn this address display on or off using the Options (O) command. For more information on the Options command, see page 422.

## The Register Window

The Register window displays the names and current values of the native CPU registers and flags. When you are debugging p-code, it displays names and values of the p-code registers and flags. You can change the value of any register or flag directly in the Register window.

To open the Register window, choose Register from the Windows menu, press ALT+7, or F2. You can also view and modify registers by using the Register (R) command. For more information about the Register command, see page 426.

When a register value changes after a program step or trace, CodeView highlights the new value so you can see how your program uses the CPU registers. Depending on the current instruction, the Register window also displays the effective address at the bottom of the window. This display shows the location of an operand in physical memory and its value.

If you are debugging on an 80386 or 80486 machine, you can view and modify the 32-bit registers. To turn on the 32-bit Registers option, choose the 386 command from the Options menu or use the O3+ command. The 32-bit registers are available if you are debugging on an 80386 or 80486 machine.

When you are debugging p-code, CodeView displays the p-code registers: DS, SS, CS, IP, SP, BP, PQ, TH, and TL.

If your program has taken an unexpected turn, you may be able to compensate for the problem and continue debugging if you change the value of a register or a flag. You can change a flag value before a dump or looping instruction to test a different branch of code, for example. You can change the instruction pointer (CS:IP) to jump to any code in your program or to execute code you have assembled elsewhere in memory.

To change the value of any register, move the cursor to the register value you want to change and overwrite the old value with the new value. The cursor automatically moves to the next register.

Although you cannot change the value of the flag register numerically in the Register window, you can conveniently toggle the values of each flag using either the mouse or the keyboard:

- ◆ To toggle a flag with the mouse, double-click the flag.
- ◆ To toggle a flag using the keyboard, move the cursor to the flag and press any key except ENTER, TAB, or ESC. After toggling a flag, CodeView moves the cursor to the next flag.

To restore the value of the last flag or register that you changed, choose Undo from the Edit menu or press ALT+BACKSPACE. If you happen to lose the cursor somewhere in the register window, press TAB. The TAB key moves the cursor to the next register or flag that can be changed.

## The 8087 Window

The 8087 window displays the current status of the math coprocessor's registers and flags. If you are debugging a program that uses the software-emulated coprocessor, the emulated registers are displayed. To open the 8087 window, choose 8087 from the Windows menu or press ALT+8.

The display in the 8087 window is the same as the display produced by the 8087 (7) command, except that the window is continually updated to show the current status of the math coprocessor. For more information about the display, see the "8087" command on page 448.

If your program uses floating-point libraries provided by several Microsoft languages, or if your program does not use floating-point arithmetic, the 8087 window and 8087 command display the message:

```
Floating point not loaded
```

CodeView displays this message until at least one floating-point instruction has been executed.

## The Memory Windows

Memory windows display memory in a number of formats. CodeView allows two Memory windows to be open at the same time. You can open a Memory window in several ways:

- ◆ From the Windows menu, choose Memory 1 or Memory 2.
- ◆ From the Options menu, choose Memory1 Window when no Memory windows are open.
- ◆ In the Command window, enter the View Memory (**VM**) command.
- ◆ At the keyboard, press ALT+5 or ALT+6.

By default, memory is displayed as bytes or as the last type specified by a Memory Enter (**ME**), Memory Dump (**MD**), or View Memory (**VM**) command. The byte display shows hexadecimal byte values followed by an ASCII representation of those byte values. For values that are outside the range of printable ASCII characters (decimal 32 to 127), CodeView displays a period (.).

## How to Change Memory Display Format

It is not always most convenient to view memory as byte values. If an area of memory contains character strings or floating-point values, you might prefer to view them in a directly readable form.

To change the display format of a Memory window, choose Memory1 Window or Memory2 Window from the Options menu. CodeView displays a dialog box where you can choose from a variety of display options. When the cursor is in a Memory window, you can press CTRL+O to display the corresponding Memory Window Options dialog box. You can also set memory display options using the View Memory (VM) command. For detailed information about the display options, see “View Memory” on page 431.

To cycle through the display formats, click the <Sh+F3=Mem1Fmt> or <Sh+F3=Mem2 Fmt> buttons on the status bar, or press SHIFT+F3. Pressing CTRL+SHIFT+F3 displays the cycle in reverse order.

When you first open the Memory window, it displays memory starting at address DS:00. To change the starting address, use one of the commands to set Memory window options. You can specify the starting address or enter an expression to use as the starting address.

You can also type over the *segment:offset* addresses shown in the left column of the Memory window to change the displayed addresses. Move the cursor to an address in the window, or repeatedly press TAB until the cursor is on an address, and type a new address.

## How to Change Memory Directly

To change the values in memory, overwrite the value you want to change. To move quickly from field to field in the Memory window, press TAB. You can change memory by entering new values for the format that is displayed or by typing over the raw bytes in the window. CodeView ignores the input if you press a key that does not make sense for the current format (for example, if you type the letter X in anything but ASCII format).

To undo a change to memory, choose Undo from the Edit menu, or press ALT+BACKSPACE.

## How to View Memory at a Dynamic Address

Live expressions make it easy for you to watch a dynamic view of an array or pointer in the Memory window. “Live” means that the starting address of memory in the window changes to reflect the current value of an address expression.

To create a live expression, choose the Memory1 Window or Memory2 Window command from the Options menu. In the Memory Window Options dialog box, type

in an address expression, then turn on the Re-evaluate Expression Always (Live) option.

It is usually more convenient to view an item in the Watch window than in the Memory window. However, some items are more easily viewed using live expressions. For example, you can examine what is currently on top of the stack by entering SS:SP as the live expression.

## The Help Window

In CodeView, you can request Help:

- ◆ From the Help menu.
- ◆ By pressing F1 when the cursor is on the keyword, menu, or dialog box for which you want Help.
- ◆ By clicking the right mouse button on a Help keyword.
- ◆ Using the Help (**H**) command.
- ◆ By choosing Help from the Windows menu. You can also press ALT+0 for Help on CodeView windows.

The Microsoft Advisor Help window is displayed whenever you request Help for CodeView. For information about getting the most out of the Microsoft Advisor Help system, see Chapter 21.

## CodeView Menus

Many commands that you are likely to use frequently are in the CodeView menus. This section describes the menus and the commands or options in each menu. Not all commands are available in both versions of the CodeView debugger. When applicable, the menu descriptions discuss command availability.

## The File Menu

The File menu contains commands to load source files and other ASCII text files into the Source window, print from the active window, start an operating-system shell, and end the debugging session.

The following table summarizes the commands on the File menu. Commands marked with an asterisk are not shown in the CVW File menu:

<b>Command</b>	<b>Purpose</b>
Open Source	Opens a source, include, or other text file
Open Module	Opens a source file for a module in the program
Print*	Prints all or part of the active window
DOS Shell*	Goes to the operating-system prompt temporarily
Exit	Exits CodeView

## Open Source

The Open Source command displays the Open Source File dialog box. You can select the name of the source file, include file, or other text file to display in the active Source window.

## Open Module

The Open Module command displays the Open Module dialog box. This dialog box provides an easy way to load the source file for any module in your program. The dialog box lists the source files that make up the modules in the program you are debugging. Only those modules that include line-number or full symbolic information are listed.

CodeView displays the source file you choose in the active Source window.

## Print

In CodeView for MS-DOS only, the Print command displays the Print dialog box, which offers several options to write information in the active window to a device or a file. You can print text in the active window in the following ways:

- ◆ Window view, which prints text that currently appears in the active window
- ◆ Complete window contents, which prints the contents of the active window, including what has scrolled out of the window

To print to a file, specify a filename in the dialog box. To append the printed text to the end of the file, select Append. To overwrite a file that already exists, select Overwrite. If you specify a device instead of a file, you can choose either Append or Overwrite.

To print directly to a printer, specify the name of the printer port such as LPT1 or COM2. You must specify a filename or a device name. CodeView reports an error if you omit the name.

## DOS Shell

In MS-DOS only, you can use the DOS Shell command to leave CodeView temporarily and go to the operating-system prompt.

When you choose the Shell command, CodeView starts a second copy of the command processor specified by the COMSPEC environment variable. If there is not enough memory to open a new shell, a message appears. Even if you do have enough memory to start a command shell, you may not have enough memory to execute large programs from the shell.

While in the shell, do not start any terminate-and-stay-resident (TSR) programs, such as MSHERC.COM, and do not delete files you are working on during your debugging session. Also, do not delete any files used by CodeView, such as the CURRENT.STS file.

To return to CodeView, type exit at the operating-system prompt to close the shell. For more information about starting a shell, see the “Shell Escape” command on page 443.

## Exit

The Exit command saves the current CodeView environment and returns to the program that called CodeView, such as COMMAND.COM, PWB, or another editor. CodeView saves the window arrangement, watch expressions, option settings, and most breakpoints in the state file, CURRENT.STS. It saves current color settings in CLRFILE.CV4 if you are using CV and in CLRFILE.CVW if you are using CVW.

When you start the debugger at a later time, CodeView restores these settings. To prevent CodeView from restoring the information it stores in CURRENT.STS, start the debugger with the /TSF option or use the **Statefileread** entry in your TOOLS.INI file.

## The Edit Menu

The Edit menu contains commands to undo changes to window’s fields, copy selected text to the clipboard, and paste the contents of the clipboard into a window. For more details on editing in CodeView’s windows, see “CodeView Windows” on page 321.

The following table summarizes the commands on the Edit menu:

<b>Command</b>	<b>Purpose</b>
Undo	Reverses the last editing change
Copy	Copies the selected text to the clipboard
Paste	Inserts the contents of the clipboard at the cursor

## Undo

The Undo command (ALT+BACKSPACE) reverses the last editing action.



## Copy

The Copy command (CTRL+INS) copies selected text to the clipboard. Because input to CodeView is restricted to single lines, you can copy only a single line of text. If you select more than a single line of text, the Copy command is disabled and pressing CTRL+INS has no effect.

## Paste

The Paste command (SHIFT+INS) inserts text from the clipboard at the cursor in the Command window.

## The Search Menu

The Search menu provides commands to find strings and regular expressions in source files and to locate the definitions of labels and routines.

The following table summarizes the commands on the Search menu:

Command	Purpose
Find	Searches for a text string or pattern in the source file
Selected Text	Searches for the selected text in the source file
Repeat Last Find	Repeats the last text search
Label/Function	Searches for a label or function definition in the program

## Find

The Find command displays the Find dialog box. In the Find What text box, type the text or pattern you want to find. You can also select text in a window and then choose Find. The text you selected is shown in the dialog box.

You can select options in the dialog box to modify the way CodeView searches for text. The following options are available:

### Whole Word

CodeView matches the text only when it occurs as a word by itself. For example, when you search for the pattern `print` with the Whole Word option, CodeView finds `print("eep")`, but not `error_print("eep")`.

### Match Case

CodeView matches the text when each letter in the pattern has the same case as the source file. For example, the pattern `fish` matches `fish`, but not `Fish`.

### Regular Expression

CodeView treats the text as a regular expression. Regular expressions provide a powerful way to specify patterns that match several different sections of text. For more information about regular expressions, see Appendix A.

To search for a regular expression in the active Source window using the Command window, you can type the Search (/) command followed by the string. CodeView searches the file starting at the current position. CodeView places the cursor on the next occurrence of the search pattern. If the end of the file is reached without finding a match, CodeView wraps around and continues searching from the beginning of the file.

## Selected Text

The Selected Text command (CTRL+) searches for the next occurrence of the selected text in the Source window.

## Repeat Last Find

The Repeat Last Find command (ALT+) searches for the next occurrence of the search pattern, including search options, you last specified.

## Label/Function

The Label/Function command lets you search the program's symbolic information for the definition of a label or routine. When you choose Label/Function, the Find Label/Function dialog box appears. The currently selected text or the word at the cursor comes up in the Label/Function Name text box. You can search for this name or type in a different label or routine name.

When you choose OK, CodeView searches the symbolic information in the program for the name. When the label or routine name is found, CodeView positions the cursor at the name in the source file.

To view the current program location after searching, choose the first item in the Calls menu or type the Current Location (.) command in the Command window.

## The Run Menu

The Run menu consists of commands to restart the program, animate the program in slow motion, change the program's arguments, load a new program, or configure the modules CodeView is using.

The following table summarizes the commands on the Run menu:

<b>Command</b>	<b>Purpose</b>
Restart	Restarts the program
Set Runtime Arguments	Changes the program's run-time arguments and restarts the program
Animate	Executes the program in slow motion
Load	Loads a new program to debug, sets run-time arguments, and configures CodeView's modules

## Restart

The Restart command resets execution to start at the beginning of the program. After you issue the command, CodeView:

- ◆ Initializes all program variables.
- ◆ Resets the pass counts for all breakpoints.
- ◆ Preserves existing breakpoints, watch expressions, and the program's command-line arguments.

You can use Restart any time after execution stops: at a breakpoint, while stepping or tracing, or when your program ends. If your program redefines interrupts, Restart may not work correctly because it does not execute any cleanup or exit-list code in the program. If your program requires this code to be executed, let the program run to the end before restarting, or use the Display Expression (?) command in the Command window to call the cleanup routines. For more information on calling program routines, see "Display Expression" on page 452.

## Set Runtime Arguments

The Set Runtime Arguments command lets you change your program's command-line arguments. When you set new arguments, CodeView restarts the program.

## Animate

The Animate command executes your program in slow motion. CodeView highlights each statement in the Source window as your program executes. This allows you to see the flow of execution. To stop animation, press any key.

You can set the animation speed with the Trace Speed command from the Options menu or with the Trace Speed (T) Command-window command.

## Load

The Load command displays the Load dialog box, which you can use to:

- ◆ Load executable (.EXE or .DLL) files.
- ◆ Change the program's command-line arguments.
- ◆ Specify different CodeView components from those specified in TOOLS.INI, such as a different expression evaluator or the p-code execution model.

### Loading Programs or DLLs

To load program or DLL symbols into the debugger, type a filename in the File to Debug text box, or use the mouse or keyboard to select a file from the File List box. Use the Drives/Dirs list box to change to a different drive or directory.

### Set Command-Line Arguments

Use the Arguments text box to change the command-line arguments to the program you are debugging or to set entirely new arguments. Type the arguments to your program as you would on the command line.

### Configure CodeView Modules

CodeView uses a default setting for an execution model, transport layer, and expression evaluator if any of these is not specified in TOOLS.INI. Choose the Configure button to load different CodeView DLLs. The Configure dialog box lists the DLLs that CodeView has loaded. CodeView loads several DLLs that are required to debug your programs. These DLLs include:

- ◆ Expression evaluators for various languages and environments.
- ◆ Execution models for various operating systems.
- ◆ Execution models for p-code.
- ◆ Transport layers.

To load new DLLs, choose the Change buttons on the right side of the dialog box.

## The Data Menu

The Data menu provides commands to add and delete watch expressions and breakpoints. Watch expressions allow you to observe how variables change as your program executes and also to expand arrays and dereference pointers. Breakpoints allow you to stop execution of your program to check the values of your variables, determine execution flow, and change how your program executes.

For more information about watch expressions, see Chapter 11, “Using Expressions in CodeView” and the “Add Watch Expression” command on page 436.

The following table summarizes the commands on the Data menu:

Command	Purpose
Add Watch	Adds an expression to the Watch window
Delete Watch	Deletes an expression from the Watch window
Set Breakpoint	Sets a breakpoint in the program
Edit Breakpoints	Modifies or removes existing breakpoints
Quick Watch	Displays a quick view of a variable or expression

## Add Watch

The Add Watch command (CTRL+W) displays the Add Watch dialog box, which shows the selected text or the word at the cursor in the Expression text box. You can enter a different expression or add a format specifier to the expression. When you choose OK, the expression is added to the end of the Watch window.

## Delete Watch

The Delete Watch command (CTRL+U) displays the Delete Watch dialog box, which displays a list of the watch expressions in the Watch window. Select the expression you want to delete from the list and choose OK. Choose the Clear All button to remove all expressions from the Watch window.

You can also delete expressions directly from the Watch window. Use the mouse or the cursor keys to move the cursor to the expression you want removed, and press CTRL+Y.

## Set Breakpoint

The Set Breakpoint command displays the Set Breakpoint dialog box, which allows you to select from several kinds of breakpoints and set options for each type. The following list describes the breakpoints you can set:

### Break at Location

This is the simplest type of breakpoint. You specify an address or a line number where you want execution to pause. To specify a line number, precede it with a period (.); otherwise, CodeView will interpret it as an address. When your program's execution reaches the breakpoint location, your program stops temporarily, and you can enter CodeView commands.

### Break at Location if Expression is True

You specify a location and an expression. Whenever execution reaches that location, CodeView checks the expression. If the expression is true (nonzero), the breakpoint is taken. Otherwise, execution continues.

#### Break at Location if Expression has Changed

You specify a location and an expression that represents a variable or any portion of memory. To specify a range of memory, enter the length of the range in the Length text box. CodeView checks the variable or the range of memory when execution reaches the breakpoint location. If the value of any byte has changed since the last time CodeView checked, the breakpoint is taken. Otherwise, execution continues.

#### Break When Expression is True

This breakpoint is taken whenever the expression becomes true. CodeView evaluates the expression after every line or every instruction, instead of only at a certain location. As a result, this type of breakpoint can greatly slow your program's execution.

#### Break When Expression has Changed

CodeView checks the variable or the range of memory as each line or each instruction is executed. You can also specify a range with the Length text box. This type of breakpoint can also slow your program's execution.

Each breakpoint is numbered, beginning with 0. For each type of breakpoint, you can set several options. If you try to use an option that does not apply to a certain breakpoint, CodeView displays N/A in the edit box and ignores that option. The options are:

#### Location

Specifies where CodeView should evaluate the breakpoint.

#### Expression

Specifies an expression that causes a break when it becomes true or a location that is to be watched for changes.

#### Length

Specifies a range of memory (starting at the address in the Expression text box) to watch for changes.

#### Pass Count

Specifies the number of times to pass over the breakpoint when it otherwise would be taken. For example, a pass count of 10 tells CodeView to ignore the breakpoint ten times.

#### Commands

Specifies a list of Command-window commands, separated by semicolons, that are executed when the breakpoint is taken. If several breakpoints with commands are taken, the commands are queued and executed in first-in, first-out order.

As shortcuts, you can also set simple (break at location) breakpoints with the following methods:

- ◆ Double-click the line in the Source window.
- ◆ Move the cursor to the breakpoint location in the Source window and press F9.

A line with a breakpoint is highlighted. In the Mixed and Assembly modes, an assembly-language comment that displays the breakpoint number appears. For example:

```
0047:0b30 57          push di                      ;BK0
```

In this example, breakpoint number 0 is set at the address 0047:0B30.

You can also set breakpoints with the Breakpoint Set (**BP**) command. See the “Breakpoint Set” command on page 405.

## Edit Breakpoints

The Edit Breakpoints command displays the Edit Breakpoints dialog box, where you can add, remove, change, enable, and disable breakpoints. Select a breakpoint from the list of breakpoints, then choose one of the command buttons on the right side of the dialog box.

The list of breakpoints in the Edit Breakpoints dialog box shows the current state of each breakpoint in your program. For more information on the format of the breakpoint list, see the “Breakpoint List” command on page 405.

The command buttons in the Edit Breakpoints dialog box are described in the following table:

Button	Description
Add	Adds a new breakpoint
Remove	Removes the selected breakpoint
Modify	Modifies the same breakpoint
Enable	Activates a disabled breakpoint
Disable	Disables an active breakpoint
Clear All	Removes all breakpoints

If you choose the Modify button, CodeView displays the Set Breakpoint dialog box with the appropriate options set for the breakpoint you selected. You can then modify the options and set the breakpoint just as you do with the Set Breakpoint command.

When you disable a breakpoint by selecting the Disable button, CodeView does not evaluate the breakpoint. Program execution continues as if the breakpoint was never set.

You may encounter several occasions where it is useful to disable a breakpoint. Sometimes a certain breakpoint is not practical when you are debugging a routine nested deeply in your program. You can re-enable the breakpoint later when you really need it. Also, conditional breakpoints are evaluated at every program step and can slow execution. You can disable some conditional breakpoints in areas of your program where you're certain you won't need them.

## Quick Watch

The Quick Watch command (SHIFT+F9) displays the Quick Watch dialog box, which shows the variable at the cursor position or the selected expression. The Quick Watch dialog box is similar to the Watch window. However, you mainly use Quick Watch for a quick exploration of the current values in an array or a pointer-based data structure, rather than as a method to constantly display the values.

The Quick Watch dialog box automatically expands structures, arrays, and pointers to their first level. You can expand or contract an element just as you can in the Watch window. If the expanded item needs more lines than the Quick Watch dialog box can display, you can scroll the view up and down.

Choose the Add Watch button to add a Quick Watch item to the Watch window. Expanded items appear in the Watch window as they are displayed in the Quick Watch dialog box.

For complete information on using the Quick Watch dialog box, see the "Quick Watch" command on page 453.

## The Options Menu

The Options menu contains commands to change the default behavior of CodeView commands and the display status of CodeView windows. You can also set display options with various Command-window commands. When the cursor is in one of the Source, Memory, or Local windows, you can press CTRL+O to display the window's Options dialog box.

For menu items that are toggles, a bullet appears to the left of the item when the option is turned on. No bullet appears when it is turned off.

The following table summarizes the commands on the Options menu:



Command	Purpose
Source1 Window	Sets Source window 1 display options
Source2 Window	Sets Source window 2 display options
Memory1 Window	Sets Memory window 1 display options
Memory2 Window	Sets Memory window 2 display options
Local Options	Sets Local window display options
Trace Speed	Sets animation speed
Language	Sets the expression evaluator
Horizontal Scrollbars	Toggles horizontal scroll bars on windows
Vertical Scrollbars	Toggles vertical scroll bars on windows
Status Bar	Toggles the status bar display
Colors	Changes colors of CodeView screen elements
Screen Swap	Toggles screen exchange
Case Sensitivity	Toggles case sensitivity of symbols
32-Bit Registers	Toggles display of 32-bit registers
Native	Toggles display of p-code or machine code instructions

## Source Window

The Source Window command displays the Source Window Options dialog box. In this dialog box, you can set the source display mode and other options for the current Source window. These options are as follows:

Option	Description
Follow CS:IP thread of control	Keeps the current program location visible in the active Source window.
Source	Displays the source code for the program.
Mixed Source and Assembly	Displays each source line followed by the disassembly of the code generated for that line.
Assembly	Displays a disassembly of the machine code in your program.
Tab Length	Sets the number of spaces to which tab characters expand in the source file.
Show Machine Code	Shows the address and hexadecimal representation of the machine code in Mixed and Assembly modes.
Show Symbolic Name	Shows the symbol name in assembly-language displays instead of the numeric value of the symbol.

The Source Window Options dialog box also contains all the options available with the VS (View Source) command. For information on the VS command, see “VS (View Source)” on page 433.

## Memory Window

The Memory Window command displays the Memory Window Options dialog box, where you can set the starting address and display format of the active Memory window. For details, see “The Memory Windows” on page 330 and the “View Memory” command on page 431.

## Local Options

You can specify the scope of variables to be displayed in the Local window. When you select Local Options from the Options menu, a dialog box appears in which you can select any combination of lexical, function, module, executable, and global scopes. You can also toggle the display of addresses in the Local window from the Local Options dialog box. When you turn Show Addresses on, the BP-relative address of each local variable is shown in the Local window. Otherwise, the Local window shows only the names of the variables.

You can also use the Options (**OL**) command in the Command window to specify the scope of variables to be displayed in the Local window. For information about the Options command, see page 422.

## Trace Speed

The Trace Speed command displays the Trace Speed dialog box, which presents a list of three speeds from which you can select.

When you use the Animate command to run your program in slow motion, CodeView pauses execution between each step. The duration of the pause is set with the Trace Speed command. **Slow** pauses for 1/2 second. **Medium** pauses for 1/4 second. **Fast** runs the program as fast as possible while still updating CodeView windows and evaluating breakpoints and watch expressions.

## Language

The Language command displays the Language dialog box, which presents a list of the expression evaluators that CodeView has loaded, plus the **Auto** option.

In your TOOLS.INI file, you can configure CodeView to load a number of different expression evaluators. You can also load expression evaluators by choosing Load from the Run menu. Only one expression evaluator can be active at a time.

The **Auto** setting is the default. It tells CodeView to set the expression evaluator automatically based on the extension of the source file you are debugging in the current Source window. For more information on expression evaluators, see “Configuring CodeView with TOOLS.INI” on page 301.

For more information on using expression evaluators, see Chapter 11, “Using Expressions in CodeView.”

## Horizontal Scrollbars

The Horizontal Scrollbars command toggles the horizontal scroll bars on and off. When scroll bars are off, you can drag the bottom window frame, as well as the size box, to resize the window.

## Vertical Scrollbars

The Vertical Scrollbars command toggles the vertical scroll bars on and off. When scroll bars are off, you can drag the right window frame, as well as the size box, to resize the window.

## Status Bar

The Status Bar command toggles the status bar on and off. When the status bar is off, you gain an extra line of space for windows.

## Colors

The Colors command displays a dialog box that lets you change the colors of CodeView screen elements. The Item list box displays all the elements of the debugging screen. The Foreground and Background list boxes show the current color settings for the highlighted element in the Item list box.

To change the color of a screen element, choose an element in the Item list box, then choose foreground and background colors. When you are done, click the OK button. Your new color settings take effect as soon as you exit the dialog box.

If you make a number of changes and want to go back to your previous color settings, click the Reset button. You can then start changing colors again. To close the dialog box without making any changes, click the Cancel button. To reset to the standard CodeView colors, click the Use Default button.

When you specify colors using the Colors command in CodeView, the colors are saved in CLRFILE.CVW if you are using CodeView for the Windows Operating System and in CLRFILE.CV4 if you are using CodeView for DOS. CodeView saves these files in the directory specified by the INIT environment variable or in the current directory if no INIT environment variable is set. These settings become the new default colors.

## Screen Swap

The Screen Swap command toggles screen exchange on or off. By default, CodeView switches to your program's output screen whenever you execute code in the program. CodeView uses either screen flipping or screen swapping, depending on the command-line options you used to start the debugger. See "Set Screen-Exchange Method" on page 313.

If your program sends no output to the screen, you'll probably want to turn Screen Swap off. This setting continuously displays CodeView's screen while your program executes.

If Screen Swap is off and your program writes to the screen, a portion of the CodeView display may be overwritten. If this happens, type the Refresh (@) command in the Command window.

## Case Sensitivity

The Case Sensitivity command toggles case sensitivity on or off. When Case Sensitivity is on, CodeView treats symbol names as case sensitive (that is, a lowercase letter is different from its corresponding uppercase letter). This option affects only commands that deal with symbols in your program; it does not affect the text-searching commands.

## 32-Bit Registers

The 32-Bit Registers command toggles 386 mode on and off. When 386 mode is on, a bullet appears next to the command on the menu, and CodeView displays the 32-bit registers in the Register window. In this mode, CodeView can also assemble instructions that use 32-bit registers or memory operands.

## Native

When you are debugging a program that uses p-code, you use the Native command to toggle between p-code instructions and native machine instructions. With Native mode on, CodeView displays your program's native CPU instructions. With Native mode off, CodeView displays the instructions in p-code.

For more information on debugging p-code, see page 363.

## The Calls Menu

The Calls menu shows what routines have been called into your program during debugging. Its contents change to reflect their current status. The current routine is at the top of the menu; the routine that called it appears just below. Routines are listed in the reverse order in which they were called. At the bottom of the list is your program's main routine. In C, for example, **main** appears at the bottom. When you are debugging a Windows-based application, **winmain** is at the bottom of the list.

The Calls menu is empty until the program enters at least one routine that creates a stack frame. Listed with each routine name are the arguments to each routine in parentheses. The menu's width expands to accommodate the widest entry. Arguments are shown in the current radix, except for pointers, which are always shown in hexadecimal.

When you choose a routine from the Calls menu, CodeView displays the source code for that routine and updates the Local window to show the local variables in that routine. The cursor moves to the return location to show the next line or instruction that will be executed when control returns to that routine.

To step out of deeply nested code, choose a routine and then press F7.

Choosing a routine from the Calls menu does not affect program execution; it provides you with a convenient way to view a routine's source code and local variables. However, since the cursor is positioned at the return location, you can press F7 to execute through the stack of nested calls to that line. This is especially convenient when you find you've accidentally traced into a deeply nested set of routines which you know to be bug-free. Rather than continue a tedious trace until you work your way out of the stack of routines, you can choose a routine from the Calls menu and press F7. CodeView executes through the nested routines until control returns to the point you chose.

A routine may not be visible in the Calls menu under the following circumstances:

- ◆ You have traced only startup or termination routines from the run-time library.
- ◆ Routine calls are nested so deeply that not all routines appear on the menu.
- ◆ The stack has been corrupted.
- ◆ CodeView cannot trace through the stack frame because the BP register is overwritten.

## The Windows Menu

If you get lost among your windows, try the Arrange command.

The Windows menu contains commands that activate, open, close, tile, arrange, and manipulate CodeView windows. There is also a command to view your program's output screen. A bullet appears to the left of the active window when you open this menu.

All the windows are numbered. You can quickly open or switch to a window by pressing ALT plus the window's number.

The following table summarizes the commands on the Windows menu and the corresponding shortcut keys:

Command	Shortcut Key	Purpose
Restore	CTRL+F5	Restores the active window to its size and position before it was maximized or minimized
Move	CTRL+F7	Moves the active window using the keyboard
Size	CTRL+F8	Sizes the active window using the keyboard
Minimize	CTRL+F9	Shrinks the active window to an icon
Maximize	CTRL+F10	Enlarges the active window to full screen
Close	CTRL+F4	Closes the active window
Tile	SHIFT+F5	Arranges all open windows to fill the entire window area
Arrange	ALT+F5	Arranges all open windows to an effective layout for debugging
Help	ALT+0	Opens or switches to the Help window
Local	ALT+1	Opens or switches to the Local window
Watch	ALT+2	Opens or switches to the Watch window
Source 1	ALT+3	Opens or switches to Source window 1
Source 2	ALT+4	Opens or switches to Source window 2
Memory 1	ALT+5	Opens or switches to Memory window 1
Memory 2	ALT+6	Opens or switches to Memory window 2
Register	ALT+7	Opens or switches to the Register window
8087	ALT+8	Opens or switches to the 8087 window
Command	ALT+9	Opens or switches to the Command window
View Output	F4	Swaps the CodeView screen for the program's output screen

## Source and Memory Windows

You can open as many as two Source and two Memory windows. At least one Source window must be open at all times. To close a window, use the Close command (CTRL+F4).

## Help, Local, Watch, Register, 8087, and Command Windows

CodeView can display one of each of these windows. The Register window has an additional shortcut key (F2) you can use to open or close it.

When you open the Help window, CodeView displays the last Help screen you viewed. If you have not yet viewed Help during the session, CodeView displays the top-level contents in the Microsoft Advisor.

## View Output

To view your program's output screen, choose View Output or press ALT+F4. CodeView displays the output screen until you press a key.

## The Help Menu

The Help menu contains commands to access the Microsoft Advisor Help system. When you choose a Help command, CodeView opens the Help window if it is not already open and displays the appropriate part of the Microsoft Advisor.

When the Help window is open, you can browse through Help with mouse and keyboard commands. All Microsoft environments provide the same mouse and keyboard commands to access the Microsoft Advisor. For more information on getting the most out of Help, see Chapter 21.

The following table summarizes the commands on the Help menu:

Command	Purpose
Index	Displays the table of Microsoft Advisor indexes
Contents	Displays the Microsoft Advisor contents screen
Topic	Displays Help on the current word
Help on Help	Displays Help on using the Microsoft Advisor
About	Displays CodeView copyright and version information

### Index

The Index command displays a table of available indexes. Each part of the Help system has its own index.

### Contents

The Contents command (SHIFT+F1) displays the contents for the entire Help system. This screen lists the table of contents for each Help system component.

### Topic

The Topic command (F1) displays help on the word at the cursor or the selected text. When you open the Help menu, CodeView displays the topic in the menu. When you choose the Topic command, CodeView displays information on the indicated topic in the Help window.

### Help on Help

The Help on Help command displays information on the Microsoft Advisor itself. It describes how the system is organized, how the mouse and keyboard commands are

used to browse through Help, and how to use the various kinds of buttons you encounter.

## About

The About command displays the CodeView copyright and version information in a dialog box.



## Special Topics

### Debugging in the Windows Operating System

The Microsoft CodeView for the Windows operating system debugger (CVW) is a powerful tool for analyzing the behavior of Microsoft Windows-based programs. With CVW, you can test the execution of your application and examine your application's data. You can isolate problems quickly because you can display any combination of variables—global or local—while you halt or trace your application's execution.

### Comparing CVW with CV

The CVW windows, menus, and commands are used in the same way as for CV. See Chapter 9, "The CodeView Environment," for details on the format of CodeView windows and how to use the windows and menus. Like the MS-DOS CodeView, CVW allows you to display and modify any program variable, section of addressable memory, or processor register. However, CodeView for Windows differs from CV in the following ways:

- ◆ Because the Windows operating system has a special use for the ALT+/ key combination used by CV to repeat a search, CVW uses CTRL+R.
- ◆ CVW tracks your application's segments and data as the Windows operating system moves them in memory. Thus, when you refer to an object by name, CVW always supplies the correct address.

CVW also provides six additional Command-window commands for Windows-based program debugging, which are summarized in the following list:

**Windows Display Global Heap (WDG)**

Displays memory objects in the global heap.

**Windows Display Local Heap (WDL)**

Displays memory objects in the local heap.

**Windows Dereference Local Handle (WLH)**

Dereferences a local heap handle to a pointer.

**Windows Dereference Global Handle (WGH)**

Dereferences a global heap handle to a pointer.

**Windows Display Modules (WDM)**

Displays a list of the application and DLL modules currently loaded in the Windows operating system.

**Windows Kill Application (WKA)**

Terminates the task that is currently executing by simulating a fatal error.

For details on using these commands, see “CVW Commands” on page 357.

The following CV features are not available in CVW.

- ◆ The Print command from the File menu.
- ◆ The DOS Shell command from the File menu and the corresponding Shell (!) Command-window command.
- ◆ The Screen Swap command from the Options menu and the corresponding Options (OF) Command-window command.

## Preparing to Run CVW

Before beginning a CVW debugging session, you must ensure that your system is configured correctly and the Windows-based application you are going to debug is compiled and linked with the options that generate CodeView debugging information.

For information on setting up your system and configuring CodeView, see “Setting up CodeView” on page 299. For information on preparing programs for use with CodeView, see “General Programming Considerations” on page 294 and “Compiling and Linking” on page 295.

The SETUP program installed the two files in your MASM\BIN subdirectory: CVW.EXE and CVW1.386. These two files must be in the current path. Also, in order for CodeView to run properly with the Windows operating system, the line:

```
device = drive:\MASM\BIN\CVW1.386
```

must appear under the [[386 Enh]] section of your SYSTEM.INI file, where *drive* is the hard disk drive where MASM resides.

The window that CodeView uses cannot be sized or moved as can other Windows operating system applications. You can specify a different starting position for CodeView using the /X and /Y command-line options. For information on the CodeView command-line options, see page 310.

## If You Use the Windows Operating System Version 3.0

If the Windows operating system Version 3.0 is running in Standard Mode and CodeView is invoked with the /X option or with no parameters, Windows Version 3.0 will generate an error when CodeView attempts to switch to protected mode. This conflict only occurs with Windows Version 3.0 running in standard mode. You can avoid this by configuring a PIF file.

For CodeView to run under Windows Version 3.0, create a PIF file using the PIF Editor. In the Optional Parameters field, enter only a question mark (?). This instructs Windows 3.0 to prompt for additional options when CodeView is invoked. When the PIF file is run, it will prompt for the command line. Specify the appropriate parameter as listed below, followed by the name of the program to be debugged.

Windows Mode	Switch(es)
Real	/D or none
Standard	/D
386 enhanced	/D (or /E if expanded memory is available)

## Starting a Debugging Session

Like most Windows-based applications, CVW can be started in several ways. You can double-click the CVW icon and respond to CVW's prompts for arguments, or you can run CVW by using the Run command from the Program Manager File menu.

To specify CVW options, choose the Run command from the Program Manager File menu. The Windows operating system displays a dialog box where you can enter the appropriate options for your debugging session. For specific information on CodeView command-line syntax and options, see "The CodeView Command Line" on page 308.

You can run CVW to perform the following tasks:

- ◆ Debug a single application
- ◆ Debug multiple instances of an application
- ◆ Debug multiple applications
- ◆ Debug dynamic-link libraries (DLLs)

This section describes the methods you use to perform these tasks and summarizes the syntax of the CVW command line for each task.

## Starting CVW for a Single Application

After you start CVW from Windows, CodeView displays the Load dialog box.

➤ **To start debugging a single application:**

1. Type the name of the application in the File to Debug text box. CVW assumes the .EXE filename extension if you do not include an extension for the application name. You can also pick the program that you want to debug by choosing it from the Files List box.
2. If you want to specify command-line arguments, move the cursor to the Arguments text box and type the program's command line.
3. Choose OK.  
CVW loads the application and displays the source code for the application's **WinMain** routine.
4. Set breakpoints in the code if you desire.
5. Use the Go (**G**) command (F5) to begin executing the application.

➤ **To avoid the startup dialog boxes:**

1. Choose the Run command from the Windows File menu.
2. Type the application name and arguments on the CVW command line. Use the following syntax to start debugging a single application:  
`CVW [[options]] appname[.EXE] [[arguments]]`
3. Choose OK.

## Starting CVW for Multiple Instances of an Application

The Windows operating system can run multiple instances of an application, which can cause problems. For example, each instance of an application might corrupt the other's data. To help you solve such problems, CVW allows you to debug multiple instances of an application. The breakpoints you set in your application apply to all of the instances. To determine which instance of the application has the focus in CVW, examine the DS register.

➤ **To debug multiple instances of an application:**

1. Start CVW as usual for one instance of your application.
2. Run additional instances of your application by choosing the Run command from the Windows File menu.

You cannot specify the application name more than once on the CVW command line. Any additional application names are passed as arguments to the first application.

## Starting CVW for Multiple Applications

You can debug two or more applications at the same time, such as a dynamic data exchange (DDE) client and server.

→ **To debug several applications at the same time:**

1. Start CVW as usual for a single application.
2. Choose Load from the Run menu and choose other applications that you also want to debug.
3. Set breakpoints in either or both applications. You can use the Open Module command from the CVW File menu to display the source code for the different modules. If you know the module and the location or function name, you can use the context operator ( { } ) to directly set breakpoints in the other applications.
4. Use the Go (G) command (F5) to start running the first application.
5. Choose the Run command from the Windows File menu to start running the second application.

You can also use the /L option on the CVW command line to load the symbols for additional applications, as shown in this example:

```
CVW /Lsecond.exe /Lthird.exe first
```

The /L option and name of each additional application must precede the name of the first application on the command line. You must specify the .EXE filename extension for the additional applications. Repeat the /L option for each application to be included in the debugging session.

Once CVW starts, choose the Run command from the Windows File menu to start executing the additional applications.

---

**Note** Global symbols with the same name in several applications (such as `winMain`) may not be distinguished. You can use the context operator to specify the exact instance of a symbol.

---

## Starting CVW for DLLs

You can debug one or more DLLs while debugging an application.

→ **To debug a DLL at the same time as an application:**

1. Start CVW as usual for the application.
2. Choose Load from the Run menu and type the name of the DLL.

3. Set breakpoints in the application or DLL. You can use the Open Module command from the CVW File menu to display the source code for the different modules.
4. Use the Go (**G**) command (F5) to continue executing the application.

You can also use the /L option on the CVW command line to specify the DLLs, as shown in this example:

```
CVW /Lappdll appname
```

The /L option must precede the name of the application. Repeat the /L option for each DLL you want to debug.

### Debugging the LibEntry DLL Initialization Routine

CVW allows you to debug the **LibEntry** initialization routine of a DLL. If your application implicitly loads the library, however, a special technique is required to debug the **LibEntry** routine.

An application implicitly loads a DLL if the library routines are imported in the application's module-definition (.DEF) file or if your application imports library routines through an import library when you link the application. An application explicitly loads a DLL by calling the **LoadLibrary** routine.

If your application implicitly loads the DLL and you specify the application in the Command Line dialog box, Windows automatically loads the DLL and executes the **LibEntry** routine when it loads the application. This gives you no opportunity to debug the **LibEntry** routine since it is executed when the application is loaded and before CVW gains control.

To gain control before the **LibEntry** routine is executed, you must set a breakpoint in the **LibEntry** routine before the DLL is loaded.

→ **To set this breakpoint:**

1. In the CVW Load dialog box, provide the name of a "dummy" application that does not load the library instead of the name of your application. The CALC.EXE program is provided for this purpose.
2. Load the DLL by using the Load command from the Run menu.
3. Choose the Open Module command from the CVW File menu and select the module containing the **LibEntry** routine.
4. Set at least one breakpoint in the **LibEntry** routine.
5. Use the Go (**G**) command (F5) to start the dummy application.
6. Run your application using the Run command from the Windows File menu. CVW resumes control when the breakpoint in the **LibEntry** routine is taken.

You can also specify the dummy application or DLL on the CVW command line.

→ **To begin a DLL debugging session from the command line:**

1. Type the command line:

```
CVW /Lmydll winstub
```

2. After CVW starts, do steps 3 –6 in the previous procedure to begin debugging.

## CVW Commands

CVW recognizes several commands for Windows-based program debugging in addition to the Command-window commands recognized by CV. These commands allow you to inspect objects in the global and local Windows heaps, list the currently loaded modules, trace and set breakpoints on the occurrence of Windows operating system messages, and terminate the currently executing task.

### Windows Display Global Heap

The Windows Display Global Heap (**WDG**) command lists the memory objects in the Windows global heap.

#### Syntax

**WDG** [*ghandle*]

If *ghandle* is specified, **WDG** displays the first five global memory objects that start at the object specified by *ghandle*. The *ghandle* argument must be a valid handle to an object allocated on the global heap. If *ghandle* is not specified, **WDG** displays the entire global heap in the Command window.

Global memory objects are displayed in the order in which Windows manages them, which is typically not in ascending handle order. The output format is:

#### Format

*handle address size* **PDB** *locks type owner*

Any field may not be present if that field is not defined for the block.

Field	Description
<i>handle</i>	Value of the global memory block handle.
<i>address</i>	Address of the global memory block.
<i>size</i>	Size of the block in bytes.
<b>PDB</b>	Block owner. If present, indicates that the task's Process Descriptor Block is the owner of the block.
<i>locks</i>	Count of locks on the block.
<i>type</i>	The memory-block type.
<i>owner</i>	The block owner's module name.

## Windows Display Local Heap

The Windows Display Local Heap (**WDL**) command displays the entire heap of local Windows operating system memory objects. This command's syntax takes no arguments.

### Syntax

**WDL**

The output has the following format:

### Format

*handle address size flags locks type heaptype blocktype*

Any field may not be present if that field is not defined for the block.

Field	Description
<i>handle</i>	Value of the global memory block handle
<i>address</i>	Address of the block
<i>size</i>	Size of the block in bytes
<i>flags</i>	The block's flags
<i>locks</i>	Count of locks on the block
<i>type</i>	The type of the handle.
<i>heaptype</i>	The type of heap where the block resides
<i>blocktype</i>	The block's type

## Windows Display Modules

The Windows Display Modules (**WDM**) command displays a list of all the DLL and task modules that the Windows operating system has loaded. To see a list of known modules, type the **WDM** command in the Command window.

### Syntax

**WDM**

Each entry in the list is displayed with the following format:

*handle refcount module path*

Field	Description
<i>handle</i>	The module handle
<i>refcount</i>	The number of times the module has been loaded
<i>module</i>	The name of the module
<i>path</i>	The path of the module's executable file

## Watching Windows Operating System Messages

You can trace the occurrence of a Windows operating system message or an entire class of Windows operating system messages by using the Breakpoint Set (**BP**)



command. You can stop at each message, or you can execute continuously and display the messages in the Command window as they are received.

To trace a Windows operating system message or message class, set a breakpoint using the following options:

### Syntax

**BP** *winproc* /M{*msgname*|*msgclass*} [[/D]]

*winproc*

Symbol name or address of a window function.

*msgname*

The name of a Windows operating system message, such as WM\_PAINT. The *msgname* is case sensitive.

*msgclass*

A case-insensitive string of characters that identifies one or more classes of messages to watch. Use the following characters to indicate the class of Windows operating system message:

Class	Type of Windows Message
m	Mouse
w	Window management
n	Input
s	System
i	Initialization
c	Clipboard
d	DDE
z	Nonclient

**/D**

When specified, CodeView displays the message in the command window, but your program continues executing. The message is displayed similar to the following example:

```
HWND:1c00 wParm:0000 lParm:000000 msg:000F WM_PAINT
```

For each matching message that is sent to the specified *winproc*, CVW lists the hexadecimal values of the window handle (HWND), word parameter (wParm), long parameter (lParm), and message (msg) arguments, along with the name of the message.

You can also specify a pass count and commands to be executed when the breakpoint is taken. For details on the full Breakpoint (**BP**) command syntax, see “BP (Breakpoint Set)” on page 405. Note that you can also use the Breakpoint Set command from the Data menu to set all types of breakpoints.

## Windows Kill Application

The Windows Kill Application (**WKA**) command terminates the currently executing task by simulating a fatal error. Since a fatal error terminates the application without performing any of the normal program exit processing, use **WKA** with caution.

To terminate your application, type the following command in the Command window:

### Syntax

#### **WKA**

As a result of the simulated fatal error, Windows displays an Unexpected Application Error box. After you close the box, Windows may not release subsequent mouse input messages from the system queue until you press a key.

If this happens, the mouse pointer moves on the Windows screen but Windows does not respond to the mouse. After you press any key, Windows responds to the queued mouse events.

The currently executing task is not necessarily your application, so you should use the **WKA** command only when your application is the currently executing task. You can be sure that your application is the currently executing task when CVW shows the current location at a breakpoint in your application.

For more information on using the **WKA** command, see “Terminating Your Program” on page 362.

## CVW Debugging Techniques

Debugging Windows-based programs can be challenging. Objects move around in memory. The thread of execution can be a twisting maze where it is difficult to know what code is executing or to control what code in your program is executed.

This section describes the **WLH** and **WGH** commands that you use to examine movable memory objects by their handles. It also describes ways to control your application’s execution, how to interrupt and resume debugging your application, how to handle abnormal termination from fatal errors and general protection faults, and how to resume debugging your application after a normal termination.

### Dereferencing Memory Handles

In a Windows-based application, the **LocalLock** and **GlobalLock** routines are used to lock memory handles so that they can dereference them into near or far pointers.

In a debugging session, you may know the memory object’s handle. However, you may not know what near or far address the handle references unless you are debugging in an area where the program has just completed a **LocalLock** or

**GlobalLock** routine call. To get the near and far pointer addresses for unlocked local and global handles, use the **WLH** and **WGH** commands.

For detailed information on the **WLH** and **WGH** commands, see “WLH (Windows Dereference Local Handle)” on page 441 and “WGH (Windows Dereference Global Handle)” on page 439.

## Controlling Application Execution

In CVW, all of the CodeView execution commands (Go, Program Step, Trace, and Animate) can be used to control your application’s execution. However, you should keep these restrictions in mind while using CVW:

- ◆ Attempting to use the Program Step or Trace commands to execute Windows operating system startup code in Assembly mode causes unpredictable results. To step through your application in Assembly mode, first set a breakpoint at the **WinMain** routine and begin stepping through the program only after the breakpoint is taken.
- ◆ Directly calling a Windows-based application procedure or dialog routine in the Watch window, in the Quick Watch dialog box, or with the Display Expression (?) command can have unpredictable results.

The rest of this section describes techniques and special considerations for controlling program execution in CVW.

### Interrupting Your Program

There may be times when you want to halt your program immediately. You can interrupt your program by pressing CTRL+ALT+SYSREQ. After you press CTRL+ALT+SYSREQ, CVW gains control and displays code corresponding to the current CS:IP location. You then have the opportunity to examine registers and memory, set breakpoints and watch expressions, and modify variables. To resume execution, use one of the CodeView program execution commands.

You should take care when you interrupt execution. If you interrupt execution while Windows operating system code or other system code is executing, attempting to use the Program Step or Trace commands can produce unpredictable results. When you interrupt execution, it is safest to set breakpoints in your code and then resume continuous execution with the Go command, rather than using the Program Step, Trace, or Animate commands.

For example, an infinite loop in your code presents a special problem. Since you should avoid using the Program Step or Trace commands after interrupting your application, you should try to locate the loop by setting breakpoints in places you suspect are in the loop, then resume continuous execution. When one of these breakpoints is taken, you can be sure that the currently executing code is your application code.

## Terminating Your Program

At times (such as when your application is executing an infinite loop), you may have to terminate the application. The Windows Kill Application (**WKA**) command terminates the currently executing task. Since this task is not necessarily your application, you should use the **WKA** command only when your application is the currently executing task.

If your application is the currently executing task and is executing a module containing CodeView information, the Source window highlights the current line or instruction. However, if your application contains modules that are compiled without CodeView information, it is more difficult to determine whether the assembly-language code displayed in the Source window belongs to your application or to another task.

In this case, use the Windows Display Global Heap (**WDG**) command with the value in the CS register as the argument. CVW displays a listing that indicates whether the code segment belongs to your application.

If the current code is in your application, you can safely use the **WKA** command without affecting other tasks. However, the **WKA** command does not perform all the cleanup tasks associated with the normal termination of a Windows-based application. For example, global objects created during program execution but not destroyed before you terminated the program remain allocated in the system-wide global heap. This reduces the amount of memory available during the rest of the Windows operating system session. For this reason, you should use the **WKA** command to terminate the application only if you cannot terminate it normally.

You should exercise caution when using the **WKA** command on an application that loads a DLL. If you terminate the application before it frees the DLL, the DLL remains loaded. If you rebuild the DLL and then run CVW again, the new version of the DLL doesn't get loaded.

---

**Note** The **WKA** command simulates a fatal error in your application, causing the Windows operating system to display an Unexpected Application Error message box. After you close this message box, Windows may not release subsequent mouse input messages from the system queue until you press a key.

---

If this happens, the mouse pointer moves on the Windows operating system screen, but the Windows operating system does not respond to the mouse. After you press any key, the Windows operating system responds to the queued mouse events.

## Handling Abnormal Termination of the Application

Your application can terminate abnormally in one of two ways while you are debugging it with CVW. It can cause a fatal exit, or it can cause a general protection fault. In both cases, CVW gains control, giving you the opportunity to examine the state of the system when your application terminated. CVW allows you

to view registers, display the global and local heaps, display memory, and examine your source code.

## Handling a General Protection Fault

If the abnormal termination is caused by a general protection fault (GPF) while executing your application code, CVW displays the line of code where the error occurred. Also, the Command window displays the following message:

```
Trap 13 (0DH) -- General Protection Fault.
```

If the general protection fault occurred while executing the Windows operating system code, the CVW Command window displays a stack trace that is useful for finding the error in your source code.

## Restarting a Debugging Session

You can terminate your application without leaving CVW. The Windows operating system notifies CVW that it is terminating the application, and CVW displays the following message:

```
Program terminated normally (0)
```

The value in parentheses is the return value of the **WinMain** routine. This value is usually the *wParam* parameter of the WM\_QUIT message, which in turn is the value of the *nExitCode* parameter passed to the **PostQuitMessage** routine.

You can then use the Go command to continue the debugging session for additional DLLs or applications. You can also restart the application by using the Restart command on the Run menu.

# Debugging P-Code

Although MASM does not support p-code, certain Microsoft compilers can generate space-saving p-code instead of machine code. P-code cannot be run by the processor itself because it is not native machine code. However, when you compile a program into p-code, LINK and the Make P-Code (MPC) utility add an interpreter to your program that reads and interprets p-code instructions.

The interpreter implements a “stack machine.” The p-code instructions generally assume operands on the stack rather than take explicit registers or addresses. Because p-code instructions do not explicitly specify operands, they are extremely small. The trade-off for compact code is reduced execution speed. You use p-code when saving space is more important than speed.

CodeView allows you to debug p-code in the same way you debug native code. At the source level, debugging works the same way for p-code as it does for native code. With CodeView’s p-code execution model, you can view p-code instructions

in Mixed and Assembly modes just as you view native machine instructions. The Register window displays the p-code registers and the top eight entries of the p-code stack. If your program contains both p-code routines and native routines, CodeView automatically switches between p-code display and native display. You can also force CodeView to stay in Native mode when you want to view the native machine code of the p-code interpreter itself.

The rest of this section describes:

- ◆ How to configure CodeView to use the p-code execution model.
- ◆ How to prepare p-code programs for debugging.
- ◆ Techniques for debugging p-code.
- ◆ Limitations while debugging p-code.

## Requirements

To debug a program that contains p-code, make sure you set up CodeView with the p-code execution model. To do so, you will need a **Model** entry under the CodeView tag in TOOLS.INI.

The p-code execution model gives CodeView information about p-code instructions, addressing modes, registers, and so forth, which you need to debug p-code. With this execution model, you can debug p-code just as you can debug native machine code. Without the p-code execution model, you cannot view the source lines for p-code routines, unassemble p-code instructions, or view the p-code registers or stack. For information on the syntax of the **Model** entry, see page 305.

There is a dynamic-link library (DLL) for each p-code execution model, depending on the operating environment. The following list shows the filenames of the DLLs and the environment with which they run:

Filename	Description
NMD1PCD.DLL	Execution model for MS-DOS p-code
NMW0PCD.DLL	Execution model for the Windows operating system p-code

Specify the appropriate filename in the **Model** entry. For example, if you are debugging a Windows-based application that contains p-code, add an entry to the `[[CVW]]` section of TOOLS.INI such as:

```
Model : NMW0PCD . DLL
```

The exact syntax can vary, depending on your system configuration and other settings in TOOLS.INI.

## Preparing Programs

To debug an application that contains p-code, you must first successfully compile, link, and run the MPC utility on the application. For information on how to build p-code applications and how to mix p-code with native machine code, see your high-level language documentation.

During compilation into p-code, the compiler saves space by using p-code quoting. P-code quoting reduces program size by minimizing repeated sequences of instructions. It replaces all but one of the sequences with a special quote instruction which calls the retained sequence.

Quoting makes debugging difficult because each routine jumps to other routines that contain the quoted instructions. When you compile a program for debugging, specify the `/Of-` option to turn quoting off. When you build a release version of the program, specify `/Of` to turn quoting back on so that the compiler can generate the smallest possible code.

By default, the compiler sorts local variables by frequency of use. It arranges them on the stack so that the program can access the most frequently used variables with the shortest instructions. This optimization is called frame sorting.

Frame sorting can make debugging more difficult because local variables do not appear on the stack in the order in which you declared them. You should turn off frame sorting by specifying the `/Ov-` option to the compiler. When you build a release version, specify `/Ov` to turn frame sorting on so that the compiler generates the smallest possible code.

## P-Code Debugging Techniques

Debugging p-code is like debugging native machine code. If you are examining your program at the instruction level, you should be familiar with the machine's operation. With p-code, this is the stack machine implemented by the p-code interpreter.

For general information on the interpreter and p-code instructions, see your high-level language documentation. For information on the p-code instruction set, choose the P-Code Help button from the Microsoft Advisor's top-level contents. Help is available on each p-code instruction.

When you are debugging native code, you normally view two levels of execution: source code and machine code. P-code introduces another level between the two. You can debug at any of these levels by setting the right combination of Source, Mixed, Assembly, and Native display modes.

The next section shows how to choose the different levels and describes what happens when you trace between native and p-code.

## The Native Command

The Native command from the Options menu toggles CodeView's display of native machine code and p-code. When Native mode is turned on, a bullet appears to the left of the command on the menu.

With Native mode turned on, CodeView displays native machine instructions in the Source and Mixed display modes. The Register window and the Register command show the native CPU registers.

With Native mode turned off, CodeView displays:

- ◆ Native machine instructions in those parts of your program that contain native code.
- ◆ P-code instructions in those parts of your program that contain p-code.

Also, the Register window and the Register command show the native CPU registers when debugging a native routine, and they display the p-code interpreter's registers when debugging a p-code routine.

The distinction between Native mode on and off becomes important when you trace from a native routine into a p-code routine or from a p-code routine to a native routine. Generally, you turn Native mode off to view p-code instructions. Turn Native mode on when you want to see the action of the p-code interpreter.

### Tracing From Native Code to P-Code

With Native mode turned off, tracing into a p-code routine causes CodeView to display p-code instructions. You can animate, step, and trace each p-code instruction in your program. You can also set breakpoints at individual p-code instructions. When tracing p-code, the Register window displays the registers and stack of the p-code machine.

With Native mode turned on, tracing into a p-code routine causes CodeView to display the native machine code of the p-code interpreter. Because the p-code interpreter is a library module that does not contain debugging information, CodeView switches to Assembly mode.

### Tracing From P-Code to Native Code

With Native mode turned off, tracing from a p-code routine to a native routine causes CodeView to display native machine instructions. The Register window displays native CPU registers.

With Native mode turned on, you don't trace from p-code to native code. You trace out of the p-code interpreter and into your program's native code.



## Unassembling P-Code

You can use the View Source and Unassemble commands to display p-code instructions in the Source window. With the View Source command, change to Mixed or Assembly display mode. The Unassemble command automatically displays p-code instructions when Native mode is turned off.

CodeView can display p-code and native code in the Source window at the same time. If you use the View Source or Unassemble commands in an area with both p-code and native code, CodeView displays both types of instructions. This commonly occurs when you view a routine with a native entry point as well as a p-code entry point. The different sections of code are separated by the assembly-language **Data** directive.

If you try to unassemble p-code with Native mode turned on, CodeView interprets p-code as native code and displays meaningless instructions.

## P-Code Debugging Limitations

While CodeView makes debugging p-code as similar to debugging native machine code as possible, there are some limitations. The following list describes the commands that you cannot use with p-code:

- ◆ You cannot assemble p-code instructions.

The Assemble command allows you to assemble instructions at any location in your program, but it accepts only native machine mnemonics. It does not recognize p-code mnemonics. If you accidentally overwrite p-code, use the Restart command. The Restart command restores your program's code.

- ◆ You cannot call p-code functions.

With native code, you can use the Display Expression command to call any function. However, the Display Expression command cannot call p-code functions.

## Remote Debugging

Microsoft CodeView versions 4.00 and later support remote debugging. This allows you to debug using two machines. CodeView runs on your development machine (the host), and the program you are debugging runs on another machine (the target). You run a remote monitor program on the target machine to control the program you are debugging. The monitor communicates with CodeView through a serial connection.

Remote debugging isolates CodeView from the program being debugged so that errors in the program do not affect the debugger, and the debugger does not affect

the target system. If the program crashes the remote system, your development system continues to run.

The remote monitor demands fewer system resources than the full debugger and has fewer dependencies on the hardware and operating system. It does not use the display, the keyboard, extended memory, or expanded memory. After starting and loading the program to be debugged, it does not use the file system. Therefore, the monitor has no effect on these resources that can change your program's behavior.

You can debug large programs or programs that destabilize the operating system. You can also debug programs on older hardware or smaller systems such as laptops that cannot support the full debugger. Some bugs that you cannot reproduce while running under the full debugger appear under the remote monitor.

The process of debugging a program on a remote machine is almost the same as for local debugging. The only difference is in how you start the session. The following sections describe the hardware and files required for remote debugging and how to configure the debugger components on the host and target machines. Also included are the command-line syntax for the remote monitor and the steps you take to start a remote debugging session.

## Requirements

Remote debugging requires two computers. The host system must support the Microsoft C/C++ development system. The target system needs only enough resources to run the remote monitor and your program. You run the MS-DOS CodeView on the host system, and you run either the MS-DOS remote monitor or the Windows operating system remote monitor, according to the type of program you are debugging.

You connect the host and target machines with a null-modem cable plugged into the serial ports on the two machines. A null modem is a serial cable that connects the transmitting line at each end to the receiving line at the opposite end. For CodeView, you can tie all control lines to a TRUE signal. Note that such a cable may not be suitable for use with other software. You cannot use an extension cable with "straight-through" connections.

Any good computer store can assemble a null-modem cable for you with the correct wiring and the appropriate connectors for your host and target machines.

CodeView's serial transport layers use interrupt-driven input and output, which is supported in MS-DOS only with the COM1 and COM2 ports. Therefore, your machines must be connected using the COM1 or COM2 ports. You can use different ports on the two machines.

If you plan to debug with two machines, you must have the correct files in the correct locations on the host and target. You can start a remote session with a

TOOLS.INI file that configures CodeView for local debugging. However, it is recommended that you configure CodeView for remote debugging in TOOLS.INI.

## MS-DOS Host Files

For remote debugging, you must have the CodeView debugger CV.EXE and its associated DLLs on the host machine. The SETUP program copies all the required files when you install the development system.

You configure CodeView for remote debugging by setting entries in the TOOLS.INI configuration file. The settings for CodeView appear in the `[[CV]]` tagged section of TOOLS.INI. Your settings should specify the DLLs for remote debugging. Most of the entries are the same for local and remote debugging. The only differences are the **Native** and **Transport** entries.

The remote debugging configuration is described in the following table:

Entry	Value	Description
Symbolhandler	SHD1.DLL	MS-DOS symbol handler.
Eval	EED1lang.DLL	Expression evaluator. You must load at least one expression evaluator. Use EED1CAN.DLL for C or MASM. Use EED1CXX.DLL for C++, C, or MASM.
Model	NMD1PCD.DLL	P-code execution model. To debug p-code, you must load the p-code nonnative execution model. Specify this entry only if you are debugging p-code.
Transport	TLD1COM.DLL	The serial transport layer. (For local debugging, use TLD1LOC.DLL.)
Native	EMD1D1.DLL EMD1W0.DLL	Execution model. The execution model that you use depends on the target. Use EMD1D1.DLL for MS-DOS targets or EMD1W0.DLL for Windows operating system targets.

For more information on configuring CodeView, see “Configuring CodeView with TOOLS.INI” on page 301.

You must have your program’s executable file on both the host and target machines. The program must have the same path on the host and target machines, including drive letter and all directories. The filenames must be identical. For Windows-based applications, you must also have your application’s DLLs (if any). The DLLs that you want to debug must also have the same path on the host and target machines.

## MS-DOS Target Files

For remote debugging of an MS-DOS program, you need the MS-DOS remote monitor RCVCOM.EXE on the target machine along with your program's executable file. The program must have the same path on the host and target machines, including drive letter and all directories. The filenames must be identical.

You can set default parameters for the remote monitor in the `[[RCVCOM]]` section of a TOOLS.INI file on the target machine. For more information, see "Remote Monitor Settings in TOOLS.INI" on page 371.

## Windows-Based Target Files

For remote debugging of a Windows-based application, you need the Windows operating system remote monitor RCVWCOM.EXE and its support DLLs on the target machine along with your application's executable files. The application and DLL files that you are debugging must have the same path on the host and target machines, including drive letter and all directories. The filenames must be identical.

The Windows operating system remote monitor (RCVWCOM.EXE) and its support DLLs (TOOLHELP.DLL and DMW0.DLL) must be in a directory listed in the PATH environment variable.

You can set default parameters for the remote monitor in the `[[RCVWCOM]]` section of a TOOLS.INI file on the target machine. For more information, see "Remote Monitor Settings in TOOLS.INI" on page 371.

## Remote Monitor Command-Line Syntax

**Syntax**            `{ RCVCOM | RCVWCOM } [[/P port:[[rate]] ]] [[/R]]`

Option	Description
RCVCOM	Remote monitor for MS-DOS.
RCVWCOM	Remote monitor for the Windows operating system.
<b>/P</b>	Parameters. The specified settings override any settings made in TOOLS.INI.
<i>port:</i>	Communications port. Must be COM1: or COM2:. The default setting is COM1:.
<i>rate</i>	Bit rate. Specifies the rate at which to drive the port, up to 19,200 bits per second (bps). To specify a rate, you must also specify a port. There can be no space between <i>port:</i> and <i>rate</i> . You must specify the same bit rate for the host and target.  The default rate is 9600 bits per second. The possible rates are 50, 75, 110, 150, 300, 1200, 1600, 1800, 2000, 2400, 3600, 4800, 7200, 9600, and 19,200 bps.

Option	Description
<b>/R</b>	Resident. The monitor stays running when the host debugger exits. When /R is not specified, the monitor terminates when the host debugger exits.

**Example**

To start the remote monitor for several MS-DOS debugging sessions that use the COM2 port at 2400 bits per second, type the command:

```
RCVCOM /P COM1:2400 /R
```

**Remote Monitor Settings in TOOLS.INI**

You can set default parameters for the MS-DOS and the Windows operating system remote monitors in TOOLS.INI. If you do not specify parameters on the command line, the monitors look for TOOLS.INI in the directory specified by the INIT environment variable. You must place the settings for the remote monitors in tagged sections of TOOLS.INI. Settings for RCVCOM appear in the [[RCVCOM]] tagged section; settings for RCVWCOM appear in the [[RCVWCOM]] tagged section.

The remote monitors recognize a single **Parameters** entry. The syntax for this entry is:

**Syntax**

**Parameters:** [[*port*:[[*rate*]] ]]

You specify the *port* and *rate* as for the /P command-line option. The command-line option overrides the TOOLS.INI settings.

**Starting a Remote Debugging Session**

After the CodeView components are in their locations and properly configured, you can begin a remote debugging session.

→ **To start a remote debugging session:**

1. Transfer your program and its DLLs to the target machine.

You can copy the files to a floppy disk, transfer them across a network, or transfer them across the serial line using communications software or serial file-transfer software.

Make sure that the full path of the program on the target machine exactly matches the full path of the program on your host machine. The directory structures for your program's files on the host and target machines must also match exactly. If the paths of the files do not match, the remote monitor is unable to locate the program.

2. Start the remote monitor. If you are debugging a Windows-based application, double-click the Windows operating system remote monitor icon or use the Run command from the Program Manager File menu. For an MS-DOS program, start the monitor from the command line.

The remote monitor starts and begins polling the communications port. It waits for the host debugger to initiate the debugging session.

3. Start CodeView on the host machine. How you start CodeView depends on your settings in TOOLS.INI.

If you have configured CodeView for remote debugging in TOOLS.INI, you can specify a program on the CodeView command line or use the Load command on the Run menu to load the program. You have already configured the transport layer and execution model.

If you are running the host-machine's CodeView as a non-Windows-based application, the application window must be full screen and exclusive in foreground. You handle this through the application's .PIF file. For more information on non-Windows-based application .PIF file settings, see your Windows operating system *User's Guide*.

If you have configured CodeView for local debugging, you can start a remote session as described in the following section, "Starting CodeView for a Different Configuration."

CodeView starts, loads your program, and initiates communication with the remote monitor. You are now ready to debug.

Once the debugging session is started, you can use CodeView just as you would for a local debugging session. When you quit CodeView, the remote monitor quits (unless you specified /R when you started the monitor).

If your system has trouble maintaining the communications link between the host and target machines, reduce the bit rate.

## Starting CodeView for a Different Configuration

If you have CodeView configured for local debugging in TOOLS.INI, start CodeView without specifying a program on the command line. This allows you to change CodeView's configuration before it loads your program. It is recommended that you configure CodeView for remote debugging.

➤ **To start a remote session from a local configuration:**

1. Transfer your program and its DLLs to the target machine.
2. Start the remote monitor on the target machine.
3. On the host machine's command line, start CodeView with the following syntax:

**CV** *[[options]]*

Do not specify the program's filename or arguments.

CodeView starts and displays the Load dialog box. Instead of specifying a program and its arguments, you must first reconfigure CodeView for remote debugging.

4. Choose Configure Remote. CodeView displays the Configure Remote dialog box. Load the remote transport layer and target execution model, as follows:
  - a. Choose the TLD1COM.DLL transport layer.

Select the communications port and bit rate for the session. Make sure that the bit rate is the same on the host and target machines.
  - b. Choose the execution model for the appropriate target:
    - ◆ EMD1D1.DLL for debugging an MS-DOS program.
    - ◆ EMD1W0.DLL for debugging a Window-based application.
  - c. Choose OK.

CodeView returns to the Load dialog box.
5. Type the name of your program in the File to Debug text box, or select the name in the Files List box. Type your program's command-line arguments in the Arguments text box.
6. Choose OK.

CodeView starts, and initiates the remote session.





## Using Expressions in CodeView

The arguments to most CodeView commands are expressions. A source-level expression is a reference to a variable or a function call or one or more operations involving constants, variables, addresses, or function calls. A physical location is a register, a memory address or range, or a source-code line number that CodeView maps to an address.

To interpret expressions while maintaining its own programming language independence, CodeView uses dynamic-link libraries (DLLs) to look up symbols, parse, and evaluate expressions. These DLLs are called “expression evaluators.” This release of CodeView has two expression evaluators—one for source-level expressions in Microsoft and ANSI C and the other that handles C++. If you do not specify an expression evaluator, CodeView uses the C++ expression evaluator by default.

The C and C++ expression evaluators recognize most C operators and provide additional debugging operators that are not part of the languages. The C++ expression evaluator places certain restrictions on C++ expressions. Although there is no expression evaluator for the Microsoft Macro Assembler (MASM), the C and C++ expression evaluators support operators that simulate essential assembly-language operations. You use one of these expression evaluators when debugging MASM code.

### Common Elements

When debugging, you use a few common elements in arguments to CodeView commands that are independent of the source language or the current expression evaluator. You often refer to line numbers in source files, and, less often, to lines in text files. You also specify registers and addresses. Some CodeView commands such as Memory Fill (**MF**) accept address ranges.

This section presents the ways to specify line numbers, refer to objects in memory, and use values stored in the processor registers. It also describes the syntax for memory ranges.

## Line Numbers

Line numbers are useful for source-level debugging. In Source mode, you see a program displayed with each line numbered consecutively. CodeView allows you to use line numbers to specify the address of code generated for a line or to specify a certain line in a text file.

### Syntax

```
[[context]] .linenumber  
[[context]] @linenumber
```

The optional *context* is the context operator used to specify a certain file. When it is omitted, CodeView assumes that the line is in the current source file. The *linenumber* specifies the line in the file (numbered starting at 1). Some commands, such as the Breakpoint Set (**BP**) command, display an error message if the compiler does not generate code for the specified line. For more information on the context operator, see “The Context Operator” on page 382.

With most CodeView commands, the two forms are interchangeable because CodeView automatically maps between source lines and code addresses. The *.linenumber* form specifies a line offset from the beginning of a file. Use this form with the View Source (**VS**) command to display any text file, including files that are not source files for the program you are debugging. The *@linenumber* form specifies the address of the beginning of the code generated by the compiler for the specified line. Use this form with the Breakpoint Set (**BP**) command.

### Examples

The following example uses the Go (**G**) command to execute the program from the current location up to line 100. Since no file is indicated, CodeView assumes the current source file.

```
>G @100
```

The following commands use the View Source (**VS**) command to display text files at specific lines as follows: line 10 of the current file, line 301 of EXAMPLE.CPP, and line 22 of TESTFILE.TXT.

```
>VS .10  
>VS { ,EXAMPLE.CPP } .301  
>VS { ,TESTFILE.TXT } .22
```

## Registers

### Syntax

`[@]register`

The *register* is the name of a CPU or p-code register. You can specify a register name if you want to use the current value stored in the register. Registers are rarely needed in source-level debugging. However, they are frequently used for lower-level debugging.

When you specify an identifier, CodeView first checks the program's symbol table for the name. If the debugger does not find the name, it checks to see if the name is a register. If you want the identifier to name a register regardless of any name in the symbol table, use an at sign (@) before the register name.

For example, if your program has a symbol called *AX*, specify *@AX* to refer to the *AX* register. You can avoid this conflict by making sure that your program does not use register names as identifiers.

Table 11.1 lists the registers known to CodeView. The p-code registers are available when you are debugging p-code. The 32-bit registers are available on 80386 and 80486 machines when you turn the 386 option on.

**Table 11.1 Registers**

Register Type	Register Names
8-bit high byte	AH, BH, CH, DH
8-bit low byte	AL, BL, CL, DL
16-bit general purpose	AX, BX, CX, DX
16-bit segment	CS, DS, SS, ES
16-bit pointer	SP, BP, IP
16-bit index	SI, DI
16-bit high word*	TH
16-bit low word*	TL
Quoting*	PQ
32-bit general purpose †	EAX, EBX, ECX, EDX
32-bit pointer †	ESP, EBP
32-bit index †	ESI, EDI

\* Available only when debugging p-code

† Available only when 386 option is turned on

## Addresses

**Syntax**            `[[context]][[symbol]]`

The *context* is the context operator and specifies the point at which to begin searching for *symbol*. If *context* is omitted, the current location is used. The *symbol* is a label, variable, or function name.

**Syntax**            `[[context]][[@linenumber]]`

The *linenumber* is the number of a line in the specified file. If *context* is omitted, CodeView assumes the current file. Line numbers start at 1.

**Syntax**            `[[segment:]offset`

A full address is a *segment* and an *offset*, separated by a colon. The *segment* and *offset* can be numeric expressions, symbols, or register names. A partial address has only an *offset*; CodeView assumes a default segment address, depending on the command. Commands that refer to data (Memory Dump, Memory Enter, for example) assume the value of the data segment (DS) register. Commands that refer to code (such as Assemble, Breakpoint Set, and Go) assume the value of the code segment (CS) register.

In source-level debugging, full *segment:offset* addresses are seldom necessary. Occasionally they may be convenient for referring to addresses outside the program, such as display memory.

### Examples

In the following example, the Memory Dump Bytes (**MDB**) command dumps memory starting at offset address 100. Since no segment is given, the data segment (the default for Memory Dump commands) is assumed.

```
>MDB 100
```

In the following example, the **MDB** command dumps memory starting at the address of the element `array[[COUNT]]`.

```
>MDB array[[count]]
```

In the following example, the Unassemble (**U**) command shows a disassembly of memory starting at a point 10 bytes beyond the symbol `label`.

```
>U label+10
```

In this example, the **MDB** command dumps memory at the address having the segment value in the ES register and the offset address 200 in the current radix.

```
>MDB ES:200
```

## Address Ranges

**Syntax** `start [[end]]`

A range is a pair of addresses that defines the boundary of a sequence of contiguous memory locations. You can specify a range by giving the starting address and the ending address. In this case, the range covers *start* to *end*, inclusively. If a command takes a range but you do not supply a second address, CodeView displays enough data to fill the current size of the window.

**Syntax** `start L length`

You can also specify a range by giving its starting point and the number of objects you want included in the range. This type of range is called a “length range.” In a length range, *start* is the address of the first object, **L** indicates that this is a length range, and *length* specifies the number of objects in the range.

The size of the object is the size taken by the command. For example, the Memory Dump Bytes (**MDB**) command dumps bytes, the Memory Dump Words (**MDW**) command dumps words, the Unassemble (**U**) command unassembles instructions (which can vary in size), and so on.

### Examples

The following example dumps a range of memory starting at the `buffer` symbol. Since the end of the range is not given, the default size is assumed (128 bytes for the Memory Dump Bytes (**MDB**) command in this example).

```
>MDB buffer
```

The following example dumps a range of memory starting at `buffer` and ending at `buffer+20` (the point 20 bytes beyond `buffer`).

```
>MDB buffer buffer+20
```

The following example uses a length range to dump the same range of memory as in the previous example.

```
>MDB buffer L 20
```

The following example uses the Memory Fill (**MF**) command to fill memory with dollar sign (\$) characters starting 30 bytes before `right_half` and continuing to `right_half`.

```
>MF right_half-30 right_half '$'
```

## Choosing an Expression Evaluator

CodeView loads all the expression evaluators that you specify with **Eval** entries in TOOLS.INI. However, you need to load only one expression evaluator for most debugging tasks. This section discusses how to choose the appropriate one for your debugging environment.

If you place more than one **Eval** setting in TOOLS.INI, CodeView loads all the expression evaluators. You can specify the active evaluator by using the Language command on the Options menu or with the **USE** command. By default, CodeView automatically selects the appropriate expression evaluator based on the current source file's extension. For more information on the Language command, see page 344. For details on the **USE** command, see page 430. For information on the **Eval** entry and complete instructions for configuring CodeView, see "Setting Up CodeView" on page 299.

When you are debugging C or MASM source code, you can normally use either the C or the C++ expression evaluator. C++ is mostly a superset of C at the expression level, and both evaluators support operators for debugging MASM code. Therefore, CodeView loads the C++ expression evaluator by default when no other expression evaluators are specified.

However, you might want to use only the C expression evaluator. If you are debugging C or MASM source code, it is recommended that you specify only the C expression evaluator. If your C program uses C++ keywords as variable, function, or label names, you must use the C expression evaluator. C variable names that are C++ keywords are not recognized as variables by the C++ expression evaluator. The C++ expression evaluator requires more memory than the C evaluator. Therefore, load only the C expression evaluator when running CodeView in an environment with limited memory.

You must use the C++ expression evaluator to debug C++ because the C evaluator does not recognize C++ expressions or keywords and cannot translate the decorated names produced by the C++ compiler. If you try to debug a C++ application with the C expression evaluator, C++ expressions generate an error, and you must use the decorated symbol names.

## Using the C and C++ Expression Evaluators

When you specify the C or C++ expression evaluator, you can use most Microsoft or ANSI C and many Microsoft C++ expressions as arguments to CodeView commands.

CodeView evaluates C and C++ expressions according to the same rules as the compiler, including operator associativity and order of precedence. There are, however, a few additional operators and some exceptions to the standard syntax. See your high-level language documentation for descriptions of C and C++ expression syntax.

### Additional Operators

Both expression evaluators support the following additional operators:

- ◆ The “context” operator (`{ }`) to specify the context of a symbol.
- ◆ The colon operator (`:`) to form addresses. The colon operator has the same precedence as the multiplication, division, and remainder operators.
- ◆ The memory operators (**BY**, **WO**, and **DW**) to access memory. Each of the memory operators has the same precedence, which is the lowest of any operator recognized by the expression evaluators.

The colon and memory operators are used mostly to debug assembly-language code. For information about the colon operator, see “Addresses” on page 378. The memory operators are described in “Memory Operators” on page 389. For more information about using the context operator, see “The Context Operator” on page 382.

### Unsupported Operators

The comma operator (`,`) and the conditional (`?:`) operator are not supported by the C and C++ expression evaluators. The C++ operators `.*` and `->*` are also unsupported.

The ampersand (`&`) is not supported as a bitwise AND operator. However, both expression evaluators recognize the ampersand (`&`) as an address-of operator. The C++ expression evaluator also recognizes the ampersand in type casts to create a reference type. For example, `(int &) curIndex` casts the `curIndex` variable to an **int** reference type.

## Restrictions and Special Considerations

When you are debugging C and C++ programs, the following general restrictions apply:

- ◆ When you use an expression as an argument to a CodeView command that takes multiple arguments, such as the Memory Fill (MF) command, the expression cannot contain spaces. For example, `&count+6` is allowed, but `&count + 6` is interpreted as three separate arguments. Some commands, such as the Display Expression (?) command, permit spaces in expressions.
- ◆ CodeView command names are not case sensitive, but C and C++ identifiers are case sensitive unless you turn off case sensitivity with the commands on the Options menu or the Options (O) command.
- ◆ You cannot call an intrinsic function or an inlined function in a CodeView expression unless it appears at least once as a normal function.
- ◆ CodeView limits casts of pointer types to one level of indirection. For example, `(char *)sym` is accepted, but `(char **)sym` is not. An expression such as `char far *(far *)` is also not supported.
- ◆ The C++ scope operator (::) has lower precedence in CodeView expressions than in the C++ language. In CodeView, its precedence falls between the base (:>) and postfix (++ , --) operators and the unary operators (!, &, \*, for example). In C++, it has the highest precedence.

CodeView imposes additional restrictions on C++ expressions. These restrictions and other special considerations when debugging C++ are described in “Using C++ Expressions” on page 386.

## The Context Operator

The context operator (`{ }`) is unique to CodeView. It is not part of the C or C++ languages. You use it to specify the exact context of an expression or line number that appears in more than one place in your source code. For example, you might use this operator to specify a symbol defined in an include file when the file is included more than once or to specify a name in an outer scope that is otherwise hidden by a local name.

When you use a symbol in a CodeView expression, the C and C++ expression evaluators search for that symbol in the following order:

1. Lexical scope outward. The expression evaluator searches for the symbol starting with the current block (a series of statements enclosed in curly braces) and continuing with the enclosing block. The current block is the code containing the current location (CS:IP address).
2. Function scope. The expression evaluator searches for the symbol in the current function.



3. Class scope. If debugging C++ and within the scope of a member function, the expression evaluator searches symbols of that member function's class and all its base classes. The C++ expression evaluator uses the normal dominance rules.
4. Current module. The expression evaluator searches all symbols in the current module.
5. Global symbols. The expression evaluator searches all global symbols in the program.
6. Other modules. The expression evaluator searches the global symbols in all other modules in the program.
7. Public symbols in the program.

If the name is not found in any of these places, and the name is not the name of a register, CodeView displays an error message.

The context operator lets you specify the starting point of the search and bypass the current location. Note that you cannot specify a block because a block has no name. You cannot specify a class, but you can specify a member function of the class and let the expression evaluator search outward.

## Syntax

{[[*function*]],[[*module*]],[[*dllexe*]]} [[*object*]]

### *function*

The name of a function in the program.

### *module*

The name of a source file. You must specify a source file if the function is outside the current scope. If the file is not in the current directory, you must specify the path.

### *dllexe*

The path of a program's DLL or .EXE file.

### *object*

A line number or symbol.

The context operator has the same precedence and associativity as the type-cast operator. You can omit *function*, *module*, or *dllexe*, but you must specify all leading commas. You can omit trailing commas. If a name contains a comma, you must enclose the name in parentheses.

### Example

The following example displays the value of the variable `Pos`, which is local to the function `make_box`, which is defined in the source file `DRAWBOX.C`. Assuming that there is more than one source file called `DRAWBOX.C`, the third parameter specifies that the source file containing the function `make_box` is the one used by `DISPTXT.DLL`.

```
? {make_box,C:\TREE1\DRAWBOX.C,C:\TREE2\DISPTXT.DLL}Pos
```

## Numeric Constants

Numbers used in CodeView commands represent integer constants. They are expressed in octal, hexadecimal, or decimal radix; the default is the current radix. The default input radix for the C expression evaluator is decimal. However, you can use the Radix (N) command to specify a different radix, as explained on page 444. CodeView displays the current radix in the lower-right corner of the status bar.

To override the current radix, you can use the C and C++ syntax for entering a constant of a different radix. In addition, CodeView supports the **0ndigits** syntax to specify decimal numbers independently of the current radix.

The following table summarizes the syntax for different radices:

Syntax	Radix
<i>digits</i>	Current radix
<b>0</b> <i>digits</i>	Octal (base 8)
<b>0n</b> <i>digits</i>	Decimal (base 10)
<b>0x</b> <i>digits</i>	Hexadecimal (base 16)

When hexadecimal is the current radix, it is possible to enter a value that could be either a symbol or a hexadecimal number. CodeView resolves the ambiguity by first searching for a symbol with that name. If no symbol is found, the value is a number. If you want to enter a number that is the same as a symbol in your program, use the explicit hexadecimal format (**0xdigits**).

For example, if the program contains a variable named `abc` and you enter `abc`, CodeView interprets the argument as the symbol. If you want to enter it as a number, enter it as `0xabc`.

## String Literals

**Syntax**                    `"string"`

Strings can be specified as expressions in the C format. You can use all ANSI C escape sequences within strings. For example, double quotation marks within a string are specified with the escape sequence `\ "`.

A string that you specify in a CodeView command is volatile, and you cannot rely on its existence for longer than the execution of the command. This means that you can pass a string to a function, but you cannot assign a string to a character pointer variable. For example, the command:

```
? pChar = "string"
```

is not valid. However, you can change a pointer to refer to a different string in your program. Also, if the pointer addresses a section of memory large enough to accommodate the string, you can use the Memory Enter (**ME**) command to fill the memory with a new string.

## Symbol Formats

For modules that are compiled with full CodeView debugging information (`/Zi`), the expression evaluators automatically translate the decorated names into source form. You specify and view names as they appear in your source. Therefore, debugging is easier when all modules in the program are compiled with full CodeView debugging information. For large programs, however, you may need to compile some modules to include only line numbers and public symbols (`/Zd`).

CodeView accepts and displays public symbol names as “decorated” names. The decorated name is the form of the name in the object code produced by the compiler. Public symbols are names in library routines or names in modules compiled without CodeView information (that is, compiled with the `/Zd` option, or compiled without any line or symbolic information and linked with the `/CO` option).

To get a listing of all names in their decorated and undecorated forms, specify the `LINK /MAP:FULL` option.

Name decoration is the mechanism used to enforce type-safe linkage. This means that only the names and references with precisely matching spelling, case, calling convention, and type are linked together.

Names declared with the C calling convention (either implicitly or explicitly using the `_cdecl` keyword) begin with an underscore (`_`). For example, the function `main` can be displayed as `_main`. Pascal names are converted to uppercase and have no prefix. Names declared as `_fastcall` are converted to uppercase and begin with an at sign (`@`).

For C++, the decorated name encodes the type of the symbol in addition to the calling convention. This form of the name can be long and difficult to read. The name begins with at least one question mark (?). For C++ functions, the decoration includes the function's scope, the types of the function's parameters, and the function's return type.

## Using C++ Expressions

The C++ expression evaluator accepts almost all C++ expressions, with some restrictions and some additions. This section describes these special considerations.

## Access Control

You can examine any member of a class object including base classes and embedded member objects. In CodeView, all members are available without regard to access control (public, protected, or private visibility). For example, if `myDate` has a private data member named `month`, you can examine it with the following command:

```
>? myDate.month  
3
```

## Ambiguous References

If an expression makes an ambiguous reference to a member name, you must use the class name to qualify it. For example, suppose that class `C` inherits from both class `A` and class `B`, and that `A` and `B` define a member function named `expand`. If `Cthing` is an instance of class `C`, the following expression is ambiguous:

```
Cthing.expand()
```

The following expression resolves the ambiguity and uses `B`'s `expand` function:

```
Cthing.B::expand()
```

The C++ expression evaluator applies normal dominance rules regarding member names to resolve ambiguities.

## Inheritance

When you display a class object that has virtual base classes, the members of the virtual base class are displayed for each inheritance path, even though only one instance of those members is stored. You can access members of an object through a pointer to the object, and you can call virtual functions through a pointer.

For example, when the `Employee` class defines a virtual function that is named `computePay`, which is redefined in the class that inherits from `Employee`, you can call `computePay` through a pointer to `Employee` and have the proper function executed:

```
>? empPtr->computePay()
```

You can cast a pointer to a derived class object into a pointer to a base class object; the reverse conversion is not permitted. For example, if the class `List` is derived from the class `Collection`, the cast `(Collection *)pListCustomer` is valid, but the cast `(List *)pCollectClients` is illegal.

## Constructors, Destructors, and Conversions

You can set a breakpoint on a class's constructor or a destructor (unless they are inline functions). The breakpoint is taken whenever an object of that class is created or destroyed. You can specify a breakpoint that halts execution so that you can examine your program's status. You can also specify a breakpoint that executes a command, such as displaying a message in the Command window or incrementing a counter, and then continues execution. This technique is especially useful for monitoring the creation and destruction of temporary objects created by the compiler.

You cannot call a constructor or destructor for an object, either explicitly or implicitly, by using an expression that calls for construction of a temporary object. For example, the following illegal command explicitly calls a constructor and results in an error message:

```
>? Date( 2, 3, 1985 )
```

You cannot call a conversion function if the destination of the conversion is a class because such a conversion involves the construction of an object. For example, suppose that `myFraction` is an instance of the `Fraction` class, which defines the conversion function operator `FixedPoint`. The following command results in an error:

```
>? (FixedPoint)myFraction
```

However, you can call a conversion function if the destination of the conversion is a built-in type. For example, suppose that the `Fraction` class defines a conversion function named `operator float`. The following command is legal:

```
>? (float)myFraction
```

You can also call functions that return an object or that declare local objects.

You cannot call the **new** or **delete** operators. The command

```
? pDate = new Date(2,3,1985)
```

is illegal and CodeView displays an error message.

## Overloading

You can call overloaded functions as long as there exists an exact match or a match that does not require a conversion involving the construction of an object. For example, if the `calc` function takes a `Fraction` object as a parameter, and the `Fraction` class defines a single-argument constructor that accepts an integer, the following command results in an error:

```
>? calc( 23 )
```

Even though a legal conversion exists to convert the integer into the `Fraction` object that the `calc` function expects, such a conversion involves the creation of an object and is not supported.

## Operator Functions

Operator functions for a class can be invoked implicitly or explicitly. For example, suppose that `myFraction` and `yourFraction` are instances of a class that defines **operator+**. You can display the sum of those two objects using expression syntax:

```
>? myFraction + yourFraction
```

You can also use the functional notation to call an operator function:

```
>? myFraction.operator+( yourFraction )
```

If an operator function is defined as a friend, you can call it implicitly using the same syntax as for a member function, or you can invoke it explicitly, as follows:

```
>? operator+( myFraction, yourFraction )
```

Note that operator functions, like ordinary functions, cannot be called with arguments that require a conversion involving the construction of an object.

## Debugging Assembly Language

MASM versions 5.0 and later provide type and size information for CodeView. With this information, CodeView can correctly evaluate expressions derived from assembly code (except for arrays, which require a different syntax, as discussed later in this section).

CodeView does not have an assembly-language expression evaluator. If you are using Microsoft C/C++, you can use either the C or C++ expression evaluators for debugging assembly language. The C and C++ expression evaluators provide special operators to simulate essential MASM operations.

You cannot always specify an expression in CodeView exactly as it would appear in assembly-language source code. You have to write an equivalent CodeView expression. This section describes the CodeView equivalents for MASM expressions.

## Memory Operators

A memory operator is a unary operator that returns the result of a direct memory operation. The memory operators are **BY**, **WO**, and **DW**. The C and C++ expression evaluators add the memory operators to the operators in the C and C++ languages. The memory operators are used mainly to debug assembly-language code.

**Syntax**            **{BY | WO | DW}** *address*

The **BY** operator returns a short integer that contains the first byte at *address*. This operator simulates **BYTE PTR**.

The **WO** operator returns a short integer that contains the value of the word (two bytes) at *address*. This operator simulates the Microsoft Macro Assembler **WORD PTR** operation. The **DW** operator returns a long integer that contains the value of the first four bytes at *address*. This operator simulates **DWORD PTR**.

The examples that follow use the Display Expression (?) command, which is described on page 452. The *x* format specifier used in some of these examples causes the result to be displayed in hexadecimal.

## Examples

The following example displays the first byte at the address of the variable `sum`.

```
>? BY sum
101
```

The following example displays the byte pointed to by the BP register with a displacement of 6.

```
>? BY bp+6,x
0042
```

The following example displays the first word at the address of the variable `new_set`.

```
>? WO new_set
13120
```

The following example displays the word pointed to by the stack pointer (the last word pushed onto the stack). Because the stack pointer (SP) offset register is used with no segment address, the stack segment (SS) register is assumed.

```
>? WO sp,x
2F38
```

The following example displays the doubleword at the address of `sum`.

```
>? DW sum
132120365
```

The following example displays the doubleword pointed to by the SI register. Because the SI index register is used without specifying a segment address, the DS register is assumed.

```
>? DW si,x
3F880000
```

## Register Indirection

The C expression evaluator does not recognize brackets (`[ ]`) to indicate a memory location pointed to by a register. Instead, you use the **BY**, **WO**, and **DW** operators to reference the corresponding byte, word, or doubleword values.

MASM Expression	CodeView Equivalent
BYTE PTR [bx]	BY bx
WORD PTR [bp]	WO bp
DWORD PTR [bp]	DW bp



## Register Indirection with Displacement

To perform based, indexed, or based-indexed indirection with a displacement, use the **BY**, **WO**, and **DW** operators with addition.

MASM Expression	CodeView Equivalent
BYTE PTR [di+6]	BY di+6
BYTE PTR Test[bx]	BY &Test+bx
WORD PTR [si][bp+6]	WO si+bp+6
DWORD PTR [bx][si]	DW bx+si

## Address of a Variable

Use the C address-of operator (**&**) instead of the MASM **OFFSET** operator.

MASM Expression	CodeView Equivalent
OFFSET Var	&Var

## PTR Operator

Use type casts or the **BY**, **WO**, and **DW** operators with the address-of operator (**&**) to replace the assembly-language **PTR** operator.

MASM Expression	CodeView Equivalents
BYTE PTR Var	BY &Var *(unsigned char*)&Var
WORD PTR Var	WO &Var *(unsigned *)&Var
DWORD PTR Var	DW &Var *(unsigned long*)&Var

## Strings

Add the string format specifier , *s* after the variable name.

MASM Expression	CodeView Equivalent
-----------------	---------------------

String	String,s
--------	----------

Because C strings end with a null (ASCII 0) character, CodeView displays all characters from the first byte of the variable up to the next null byte in memory when you request a string display. If you intend to debug an assembly-language program, and you want to view strings in the Watch window or with the Display Expression (?) command, you should delimit string variables with a null character. You can also view null-terminated or unterminated strings in a Memory window or with the Memory Dump ASCII (MDA) command.

## Array and Structure Elements

Prefix an array name with the address-of operator (&) and add the desired offset. The offset can be an expression, number, register name, or variable.

The following examples (using byte, word, and doubleword arrays) show how to do this.

MASM Expression	CodeView Equivalents
String[12]	BY &String+12 *(&String+12)
aWords[bx+di]	WO &aWords+bx+di *(unsigned*)&aWords+bx+di)
aDWords[bx+4]	DW &aDWords+bx+4 *(unsigned long*)&aDWords+bx+4)

## CHAPTER 12

## CodeView Reference

This chapter describes the CodeView Command-window command format, explains the common items in CodeView expressions, and summarizes all Command-window commands in a convenient table. The final section describes each command in detail. The nonalphabetic commands appear at the end of the chapter.

### Command-Window Command Format

**Syntax** *command* [[*arguments*]] [[: *command* [[*arguments*]] ]]

**Parameters** *command*

A command name. The *command* is not case sensitive; any combination of uppercase and lowercase letters can be used.

*arguments*

Expressions that represent values or addresses used by the command. Source-level expressions used as arguments may or may not be case sensitive, depending on the current expression evaluator. The first argument can be placed immediately after *command* with no space separating the two fields.

If a command takes more than one argument, you must separate the arguments with spaces.

**Remarks** Additional commands may be specified on the same line. A semicolon (;) must separate each command from the next.

### CodeView Expression Reference

When debugging, you use a few common elements in arguments to CodeView commands that are independent of the source language or the current expression evaluator. You often refer to line numbers in source files and, less often, to lines in text files. You also specify registers and addresses. Some CodeView commands such as Memory Fill (**MF**) accept address ranges.

This section presents the ways to specify line numbers, refer to objects in memory, and use values stored in the processor registers. It also describes the syntax for memory ranges. Moreover, the context operator, which you use to specify the point at which to begin searching for a symbol, is summarized. For detailed information on the context operator and CodeView expressions, see Chapter 11.

## Line Numbers

### Syntax

`[[context]]@linenumber`  
`[[context]].linenumber`

### Description

Line numbers are useful for source-level debugging. They correspond to the lines in source-code files. In source mode, a program is displayed with each line numbered sequentially. The CodeView debugger allows you to use these numbers to access parts of a program.

The memory address of the code corresponding to a source-line number is specified as:

`@linenumber`

The actual file line number is:

`[[context]].linenumber`

CodeView assumes that the source line is in the current source file. To specify a source line in a different file, you must specify the line's context using the context operator:

`{,file}@linenumber`

CodeView displays an error message if *file* does not exist or no source line exists for *linenumber*.

### Examples

The following example uses the View Source (**VS**) command to display code starting at source line 100. Since no file is indicated, the current source file is assumed.

```
>VS @100
```

This next example uses **VS** to display source code starting at line 301 of the file DEMO.C.

```
>VS {,demo.c}.301
```

## Registers

**Syntax**      `[@]register`

A register name represents the current value stored in the register. Table 12.1 summarizes the register names known to the CodeView debugger.

**Table 12.1 Register Names**

Register Type	Register Names
8-bit high byte	AH, BH, CH, DH
8-bit low byte	AL, BL, CL, DL
16-bit general purpose	AX, BX, CX, DX
16-bit segment	CS, DS, SS, ES
16-bit pointer	SP, BP, IP
16-bit index	SI, DI
16-bit high word*	TH
16-bit low word*	TL
Quoting*	PQ
32-bit general purpose†	EAX, EBX, ECX, EDX
32-bit pointer†	ESP, EBP
32-bit index†	ESI, EDI

\*Available only when debugging p-code

† Available only when 386 option is turned on

To force a symbol to represent a register, prefix the symbol with an at sign (@). For example, to make `AX` represent a register rather than a variable, use `@AX`.

## Addresses

**Syntax**            *[[context]]@linenumber*  
*[[context]][[segment:]]offset*  
*register:offset*  
*[[context]]function*  
*[[context]]symbol*

**Description**        If only an *offset* is specified, the *segment* is determined by the command in which the address appears. Commands that refer to data (Memory Dump, Memory Enter) use the segment in the DS register. Commands that refer to code (Assemble, Breakpoint Set, Go, Unassemble, and View Source) use the segment in the CS register.

The Display Expression (?) and Add Watch Expression (W?) commands interpret numeric arguments as constants rather than as offsets. However, if you cast the argument to a pointer, as in

*W? (char \*)0*

the argument is treated as an offset from DS.

---

## Address Ranges

**Syntax**            *start end*  
*start L count*

**Description**        An address range is a pair of memory addresses that specify the higher and lower boundaries of contiguous memory. You can specify a range in two ways:

- ◆ Give the starting and ending addresses:

*start end*

The range covers *start* to *end*, inclusively. If you don't supply an ending address, CodeView assumes the default range. Each command has its own default range; the most common default range is 128 bytes.

- ◆ Give the starting address and the number of objects you want included in the range:

*start L count*

This type of range is called an “object range.” The starting address is the address of the first object in the list, and *count* specifies the number of objects in the range. The way the size of an object is measured depends on the command. For example, the Memory Dump Bytes (**MDB**) command has byte objects, the Memory Dump Words (**MDW**) command has words, the Unassemble (**U**) command has instructions, and so on.

### Examples

This example dumps a range of memory starting at the symbol `buffer`. Since the end of the range is not given, the default size (128 bytes for the Memory Dump Bytes command) is assumed.

```
MDB buffer
```

The following example dumps 21 bytes starting at `buffer` and ending at `buffer+20` (the point 20 bytes beyond `buffer`).

```
MDB buffer buffer+20
```

The following example uses an object range to dump a range of memory. The `L` indicates that the range is an object range, and `20` indicates the number of objects in the range.

```
MDB buffer L 20
```

Here, each object has a size of 1 byte since that is the size of objects dumped by the Memory Dump Bytes (**MDB**) command.

---

## Context Operator ({} )

**Syntax**                    { *[[function]]* , *[[module]]* , *[[dllxe]]* } *[[object]]*

**Parameters**

*function*

The name of a function or procedure in the program. Case is significant for case-sensitive languages.

*module*

The name of a source file. If the file is not in the current directory, you must specify the path.

*dllxe*

The full path of a dynamic-link library (DLL) in the program or the program’s .EXE file.

*object*

A variable name, line number, or expression.

**Description**

The context operator specifies the exact starting point to search for a symbol or line. You apply it the same way as a type cast is applied in C. When you do not use the context operator, the current context (CS:IP) is used.

You can omit *function*, *module*, or *dll*, but all leading commas must be given. Trailing commas can be omitted. If a name contains a comma, the name must be enclosed in parentheses.

For complete information on the context operator, see “The Context Operator” on page 382.

**Example**

This example displays the value of the variable `Pos`, which is local to the function `make_box` defined in the source file `BOXDRAW.C`.

```
? {make_box,C:\PROJ\boxdraw.c}Pos
```

## CodeView Command Overview

Table 12.2 summarizes the CodeView Command-window commands. The next section describes each command in detail.

**Table 12.2 CodeView Command Summary**

Command	Name	Description
<b>A</b>	Assemble	Inserts assembly-language instructions
<b>BC</b>	Breakpoint Clear	Clears one or more breakpoints
<b>BD</b>	Breakpoint Disable	Disables one or more breakpoints
<b>BE</b>	Breakpoint Enable	Enables one or more breakpoints
<b>BL</b>	Breakpoint List	Lists all breakpoints
<b>BP</b>	Breakpoint Set	Sets a breakpoint
<b>E</b>	Animate	Executes the program in slow motion
<b>G</b>	Go	Executes the program
<b>H</b>	Help	Provides Help information
<b>I</b>	Port Input	Reads a byte from a hardware port
<b>K</b>	Stack Trace	Displays active routines K command
<b>L</b>	Restart	Restarts the program
<b>MC</b>	Memory Compare	Compares two blocks of memory byte by byte
<b>MD</b>	Memory Dump	Displays sections of memory in the Command window in various formats
<b>ME</b>	Memory Enter	Modifies memory
<b>MF</b>	Memory Fill	Fills a block of memory



**Table 12.2 CodeView Command Summary** (*continued*)

<b>Command</b>	<b>Name</b>	<b>Description</b>
<b>MM</b>	Memory Move	Copies one block of memory to another
<b>MS</b>	Memory Search	Scans memory for specified byte values
<b>N</b>	Radix	Changes current radix for entering arguments and displaying values
<b>O</b>	Options	Views or sets options
<b>O</b>	Port Output	Outputs a byte to a hardware port
<b>P</b>	Program Step	Executes the current line and steps over functions
<b>Q</b>	Quit	Terminates CodeView
<b>R</b>	Register	Displays the values of registers and flags and optionally changes them
<b>T</b>	Trace	Executes the current line and traces into functions
<b>T</b>	Trace Speed	Specifies speed for the Animate command
<b>U</b>	Unassemble	Displays assembly-language instructions
<b>USE</b>	Use Language	Specifies the active expression evaluator
<b>VM</b>	View Memory	Displays sections of memory in a Memory window in various formats
<b>VS</b>	View Source	Displays source code in varying formats in a Source window
<b>W?</b>	Add Watch	Sets an expression to be watched
<b>WC</b>	Delete Watch	Deletes one or more watch expressions
<b>WDG</b>	Windows Display Global Heap	Displays memory objects in the global heap
<b>WDL</b>	Windows Display Local Heap	Displays memory objects in the local heap
<b>WDM</b>	Windows Display Modules	Displays a list of the applications and DLL modules known by Windows
<b>WGH</b>	Windows Dereference Global Handle	Dereference a global handle
<b>WKA</b>	Windows Kill Application	Terminates the current task by simulating a fatal error
<b>WL</b>	List Watch	Lists current watch expressions
<b>WLH</b>	Windows Dereference Local Handle	Dereference a local handle
<b>X</b>	Examine Symbols	Displays the addresses and types of symbols
<b>!</b>	Shell Escape	Runs an MS-DOS shell

**Table 12.2 CodeView Command Summary** (*continued*)

Command	Name	Description
"	Pause	Interrupts execution of redirected commands and waits for keystroke
#	Tab Set	Sets number of spaces for each tab character
*	Comment	Displays explanatory text during redirection
.	Current Location	Displays the current location
/	Search	Searches for a regular expression in the source
7	8087	Shows the values of the 8087 or emulator registers and flags
:	Delay	Delays execution of redirected commands
<	Redirect Input	Reads input from specified device
>	Redirect Output	Sends output to specified device
=	Redirect Input and Output	Sends output and reads input from specified device
?	Display Expression	Evaluates and displays expressions or symbols
??	Quick Watch	Displays variables and data structures in a dialog box
@	Redraw	Redraws the screen
\	Screen Exchange	Exchanges the CodeView and output screens

## CodeView Command Reference

The rest of this chapter is an alphabetical reference to all CodeView Command-window commands. Nonalphabetic commands such as the Pause (") command are listed after the alphabetic reference.

### A (Assemble)

**Syntax**            A [[*address*]]

**Parameter**        *address*

Begins assembly at this address. If *address* is not given, assembly begins at the current assembly address (see following).

**Description**

The Assemble (**A**) command assembles 8086-family (8086/87/88, 80186/286, 80287/387, and 80286/386/486 unprotected) instruction mnemonics and places the resulting instruction code into memory at a specified address. The only 8086-family mnemonics that cannot be assembled are 80386/486 protected-mode mnemonics. In addition, the CodeView debugger can assemble 80286 instructions that use the 32-bit 386/486 registers.

If *address* is specified, the assembly starts at that address; otherwise, the current assembly address is assumed.

The assembly address is normally the current address or the address pointed to by CS:IP. However, when you use the Assemble command, the assembly address is set to the address immediately following the last assembled instruction.

When you enter any command that executes code (Trace, Program Step, Go, or Animate), the assembly address is reset to the current address.

**Entering Instructions**

Use the following procedure to assemble instructions:

1. Type the Assemble (**A**) command in the command window and press ENTER. CodeView displays the assembly address and waits for you to enter a new instruction.
2. Type a mnemonic and press ENTER. CodeView assembles the instruction into memory and displays the next available address. If an instruction you enter contains a syntax error, CodeView displays the message:

```
^ Syntax error
```

Then CodeView redisplay the current assembly address and waits for you to enter a correct instruction. The caret (^) in the message points to the first character that CodeView could not interpret.

3. Continue entering new instructions until you have assembled all the instructions you want.
4. Press ENTER without entering any mnemonic to conclude assembly and return to the CodeView prompt.

**Remarks**

Consider the following principles when you enter instruction mnemonics:

- ◆ The far-return mnemonic is RETF.
- ◆ String mnemonics must explicitly state the string size. For example, MOVSW must be used to move word strings and MOVSB must be used to move byte strings.
- ◆ CodeView automatically assembles short, near, or far jumps and calls, depending on byte displacement to the destination address. These may be overridden with the NEAR or FAR prefix. The NEAR prefix can be abbreviated to NE, but the FAR prefix cannot be abbreviated.

- ◆ CodeView cannot determine whether some operands refer to a word memory location or to a byte memory location. In these cases, the data type must be explicitly stated with the prefix **WORD PTR** or **BYTE PTR**. Acceptable abbreviations are **WO** and **BY**.
- ◆ CodeView cannot determine whether an operand refers to a memory location or to an immediate operand. CodeView uses the convention that operands enclosed in brackets (**[ ]**) refer to memory.
- ◆ CodeView supports all forms of indirect register instructions.
- ◆ All instruction-name synonyms are supported. If you assemble instructions and then examine them with the Unassemble (**U**) command, CodeView may show synonymous instructions, rather than the ones you have assembled.
- ◆ Do not assemble and execute 8087/287 instructions if your system is not equipped with a math coprocessor chip.

The effects of the Assemble command are temporary. Any instructions that you assemble are lost as soon as you exit the program.

The instructions you assemble are also lost when you restart the program with the Restart command. The original code is reloaded, possibly writing over parts of memory that you have changed.

### Example

This example places two new instructions in a program, replacing any instructions already there.

```
>a 0x47:0xb3e
0001:0B3E  mov ax,bx
0001:0B40  mov si,0x9ce
0001:0043
```

You can modify a portion of code for testing, as in the example, but you cannot save the modified program. You must modify your source code and recompile.

---

## BC (Breakpoint Clear)

### Syntax

**BC** [*list* | *start-end* | \*]

### Parameters

*list*

List of breakpoints to be removed, with breakpoint numbers separated by spaces. A number identifies each breakpoint. You can use the Breakpoint List (**BL**) command to display currently set breakpoints and their numbers.

	<p><i>start-end</i> Range of breakpoints to clear. The command clears breakpoints numbered from <i>start</i> to <i>end</i>, inclusive.</p> <p>*</p> <p>Removes all currently set breakpoints.</p>
<b>Description</b>	The Breakpoint Clear ( <b>BC</b> ) command permanently removes one or more previously set breakpoints.
<b>Mouse and Keyboard</b>	<p>In addition to typing the <b>BC</b> command, you can clear breakpoints with the following shortcuts:</p> <ul style="list-style-type: none"> <li>◆ From the Data menu, choose Edit Breakpoints.</li> <li>◆ Double-click the line containing the breakpoint.</li> <li>◆ Using the keyboard, move to the line containing the breakpoint, and press F9.</li> </ul>
<b>Examples</b>	<p>The following example removes breakpoints 0, 4, and 8:</p> <pre>&gt;BC 0 4 8</pre> <p>The following example removes all breakpoints:</p> <pre>&gt;BC *</pre> <p>The following example removes breakpoints 4, 5, 6, and 7:</p> <pre>&gt;BC 4-7</pre>

---

## BD (Breakpoint Disable)

<b>Syntax</b>	<b>BD</b> <i>[[list   start-end   *]]</i>
<b>Parameters</b>	<p><i>list</i> List of breakpoints to be disabled, with breakpoint numbers separated by spaces. A number identifies each breakpoint. You can use the Breakpoint List (<b>BL</b>) command to display currently set breakpoints and their numbers.</p> <p><i>start-end</i> Range of breakpoints to disable. The command disables breakpoints numbered from <i>start</i> to <i>end</i>, inclusive.</p> <p>*</p> <p>Disables all currently set breakpoints.</p>

**Description** The Breakpoint Disable (**BD**) command temporarily disables one or more existing breakpoints. The breakpoints are not deleted; they can be restored at any time using the Breakpoint Enable (**BE**) command.

A disabled breakpoint can be cleared using the Breakpoint Clear (**BC**) command.

In the Source window, enabled breakpoints are highlighted. However, the highlighting disappears once the breakpoint is disabled.

**Mouse and Keyboard** As an alternative to typing the **BD** command, choose Edit Breakpoints from the Data menu. There is no keyboard shortcut.

**Examples** The following example temporarily disables breakpoints 0, 4, and 8:

```
>BD 0 4 8
```

The following example temporarily disables all breakpoints:

```
>BD *
```

The following example disables breakpoints 4, 5, 6, and 7:

```
>BD 4-7
```

---

## BE (Breakpoint Enable)

**Syntax** **BE** [*list* | *start-end* | \*]

**Parameters**

*list*

List of breakpoints to be enabled, with breakpoint numbers separated by spaces. A number identifies each breakpoint. You can use the Breakpoint List (**BL**) command to display currently set breakpoints and their numbers.

*start-end*

Range of breakpoints to enable. The command enables breakpoints numbered from *start* to *end*, inclusive.

\*

Enables all currently disabled breakpoints.

**Description** The Breakpoint Enable (**BE**) command enables breakpoints that have been temporarily disabled with the Breakpoint Disable (**BD**) command.

**Mouse and Keyboard** In addition to typing the **BE** command, you can also enable breakpoints from the Data menu by choosing Edit Breakpoints. There is no keyboard shortcut.

**Examples**

The following example reenables breakpoints 0, 4, and 8:

```
>BE 0 4 8
```

The following example enables all disabled breakpoints:

```
>BE *
```

The following example enables breakpoints 4, 5, 6, and 7:

```
>BE 4-7
```

---

## BL (Breakpoint List)

**Syntax**

**BL**

**Description**

The Breakpoint List (**BL**) command lists current information about all breakpoints.

For each breakpoint, the command displays the following:

- ◆ The breakpoint number.
- ◆ The breakpoint status, where “E” is for enabled, “D” is for disabled, and “V” is for “virtual.” A virtual breakpoint is a breakpoint set in an overlay or a DLL that is not currently loaded. A virtual breakpoint may be enabled or disabled.
- ◆ The address, function, file, and line number where the breakpoint is set.
- ◆ The expression, pass count, and break commands, if set.

**Mouse and Keyboard**

In addition to typing the **BL** command, you can also list breakpoints from the Data menu by choosing Edit Breakpoints. There is no keyboard shortcut.

---

## BP (Breakpoint Set)

**Syntax**

**BP** *[[address]]* *[[**=**expression **[[/Rrange]]** ]]* *[[**?**expression]]* *[[/Ppasscount]]*  
*[[/C"commands"]]* *[[/Mmsgname/msgclass **[[/D]]** ]]*

**Parameters**

*address*

An expression giving the address at which to set the breakpoint. If omitted, sets a breakpoint on the current line, unless *=expression* is also specified.

*expression*

Breaks program execution when the value of *expression* changes. If *address* is given, the expression is checked for changes only at that address. The expression is usually the name of a variable.

***/R*range**

Watches all addresses in the given range for changes. The range is determined by multiplying *range* with the size of *expression*.

***?expression***

Breaks program execution when *expression* becomes true (nonzero). If *address* is given, the breakpoint *expression* is evaluated only at that address. You cannot specify both *=expression* and *?expression* in the same breakpoint. Also, you cannot have more than one local context in *expression*. If the *expression* contains spaces, it must be enclosed in double quotation marks ("*expression*").

***/P*passcount**

Specifies the first time the breakpoint is to be taken. For example, if *passcount* is 5, the breakpoint will be ignored the first four times it is encountered and taken the fifth time. From that point on, the breakpoint is always taken until the program is restarted.

***/C*"commands"**

A list of command-window commands to be executed when the breakpoint is encountered. The *commands* must be enclosed in double quotation marks ("") and separated by semicolons (;).

***/M*msgname**

(CVW only) Breaks program execution whenever the specified message is received. When */D* is also specified, the message received is displayed, but the breakpoint is not taken.

***/M*msgclass**

(CVW only) Breaks program execution whenever a message belonging to one of the specified classes is received. When */D* is also specified, the message received is displayed but the breakpoint is not taken. Can be one or more of the following:

Message Class	Type of Windows Message
<b>m</b>	Mouse
<b>w</b>	Window management
<b>n</b>	Input
<b>s</b>	System
<b>i</b>	Initialization
<b>c</b>	Clipboard
<b>d</b>	DDE
<b>z</b>	Nonclient

**Description**

The Breakpoint Set (**BP**) command creates a breakpoint at a specified address. Whenever a breakpoint is encountered during program execution, the program halts and waits for a new command.



You can set breakpoints at source lines, functions, explicit addresses, or labels in any module of a program. If no arguments are given, **BP** sets a breakpoint at the current line.

### Windows Breakpoints

In CodeView for Windows (CVW), use of the */M* options requires that *address* be the name or address of a window function (“winproc”).

When the */D* option is specified, CVW displays each message in the Command window as it is sent to the application’s window function. The message is displayed in the following format:

```
HWND:wh wParm:wp lParm:lp msg:msgnum msgname
```

where *wh* is the window handle, *wp* is the message’s word-sized parameter, *lp* is the message’s long-sized parameter, *msgnum* is the message number, and *msgname* is the name of the message. The following is a typical display:

```
HWND:1c00 wParm:0000 lParm:000000 msg:000F WM_PAINT
```

The Windows operating system breakpoints appear in the list of breakpoints and may be enabled, disabled, and cleared with the usual CodeView breakpoint commands.

### Breakpoint Options

For any breakpoint, you can also specify:

- ◆ A pass count to tell CodeView how many times to pass over the breakpoint.
- ◆ Commands to be executed after the program reaches the breakpoint.

Breakpoints are numbered, beginning with the number 0. Each new breakpoint is assigned the next available number. Breakpoints remain in memory until you explicitly delete them. Breakpoints are saved in the CURRENT.STS file when you exit CodeView and are restored the next time you debug the program.

### Types of Breakpoints

You can set breakpoints to break execution when any of the following conditions are true:

- ◆ The program reaches a given source line, function, label, or address.
- ◆ An expression becomes true (nonzero). The CodeView expression evaluator evaluates this type of expression based on the the currently visible function.
- ◆ The value of an expression or memory range changes. CodeView references this type of expression by memory location. As a result, the original value of the expression is checked no matter which function is currently visible.

**Mouse and Keyboard**

In addition to typing the **BP** command, you can also set a breakpoint with the following shortcuts:

- ◆ From the Data menu, choose Set Breakpoint.
- ◆ Double-click a source line.
- ◆ Move the cursor to a source line, and press F9.

**Examples**

Command	Action
<code>BP @47</code>	Set a breakpoint at line 47 of the currently executing module.
<code>BP 0x23f0:3c84</code>	Set a breakpoint at address 23F0:3C84.
<code>BP =curr_sum</code>	Halt execution whenever the value in <code>curr_sum</code> changes.
<code>BP =myint /R8</code>	Halt execution whenever a change occurs in the range of eight integers that begins at <code>myint</code> . If <code>myint</code> is a 2-byte value, the range is 16 bytes in size.
<code>BP @47 =int_array[[0]] /R20</code>	Set a breakpoint at line 47 of the currently executing module. The breakpoint will be taken at that line if any 20 elements of the array <code>int_array</code> changes. Since <code>int_array</code> is a 2-byte value, the range is 40 bytes in size.
<code>BP {,mymod}@47 ?myptr==0</code>	Set a breakpoint at line 47 of the module <code>mymod</code> . The breakpoint is taken only if <code>myptr</code> is zero.
<code>BP stats /P10 /C"?counter+=1"</code>	Set a breakpoint at the address of the function <code>stats</code> but ignore the breakpoint the first nine times the function is executed. On the tenth and later call to <code>stats</code> , stop execution, and use the Display Expression (?) command to increment the value of <code>counter</code> . If <code>counter</code> is set to 0 when the breakpoint is set, <code>counter</code> can be used to count the number of times the breakpoint is taken.

## E (Animate)

**Syntax****E****Description**

The Animate (**E**) command traces through a program one step at a time, with a user-selectable pause between each step, beginning at the current instruction. In the Source mode, CodeView pauses after each line of source text. In the Mixed or Assembly-only mode, CodeView pauses after each instruction. The Animate command allows you to see how execution proceeds in your program.

---

	You can set the time the command pauses with the Trace Speed ( <b>T</b> ) command or by choosing Trace Speed from the Options menu.
<b>Mouse and Keyboard</b>	To begin animating, you can also choose Animate from the Run menu. There is no keyboard shortcut.

---

## G (Go)

**Syntax**            **G** [*address*]

**Parameters**        *address*  
                      Address at which to stop execution.

**Description**        The Go (**G**) command starts execution at the current address. If *address* is given, CodeView executes the program until it reaches that address. If the specified address is never reached, the program executes until it terminates. If no address is given, CodeView executes the program until it terminates, until it reaches a breakpoint, or until you interrupt execution.

When CodeView reaches the end of the program in MS-DOS, it displays a message with the format:

```
Program terminated normally (number)
```

The *number* is the program's return value (also known as the "exit" or "errorlevel" code). This is the value in the AX register at the time your program terminates. For example, the C function call

```
exit (1);
```

places 1 in the AX register and terminates the program.

**Mouse and Keyboard**    In addition to typing the **G** command, you can start execution using the following shortcuts:

- ◆ Click the <F5=Go> button in the status bar.
- ◆ Press F5.

To execute up to a certain location, you can use the following shortcuts:

- ◆ Click the right mouse button on the source line.
- ◆ Move the cursor to the source line and press F7.

**Example** The following example executes up to the label `panic_exit` in the **main** function. Because labels are always local to a procedure, you must specify the context (procedure or function name) if the label is not in the current function.

```
>G {main}panic_exit
```

---

## H (Help)

**Syntax** **H** [*topic*]

**Parameter** *topic*  
Provides help on *topic*, which can be a command-window command. If no *topic* is given, the table of contents is displayed.

**Description** The Help (**H**) command displays help information in a separate window. You can get help on CodeView commands, CodeView error messages, and any other topic within the Microsoft Advisor Help system.

**Mouse and Keyboard** In addition to typing the **H** command, you can get help using the following shortcuts:

- ◆ With the right mouse button, click the keyword to display the corresponding Help topic. This method works in all CodeView windows except the Source, Memory, and 8087 windows.
  - ◆ Move the cursor to a topic and press F1 to display the corresponding Help topic.
  - ◆ Choose one of the commands on the Help menu.
- 

## I (Port Input)

**Syntax** **I** *port*

**Parameter** *port*  
A 16-bit port address.

**Description** The Port Input (**I**) command reads and displays a byte from a specified hardware port. The specified port can be any 16-bit address. CodeView displays the byte read in the Command window.

This command is often used in conjunction with the Port Output (**O**) command. Use this command to write and debug hardware-specific programs in Assembly mode.

---

**Note** This command may affect the status of the hardware using the port.

---

**Example**

The following example reads the input port numbered 2F8 and displays the result, E8. You can enter the port address using any radix, but the result is always displayed in current radix.

```
>I 2F8 ; * hexadecimal radix assumedE8
```

---

## K (Stack Trace)

**Syntax****K****Description**

The Stack Trace (**K**) command displays functions that have been called during program execution, including their arguments in the Command window. It also displays the address of the instruction that will be executed when control returns to each function.

Output from the Stack Trace command gives you the following information:

- ◆ Functions listed in the reverse order in which they were called.
- ◆ Arguments to each function, listed in parentheses.
- ◆ The address or line number of the next instruction to be executed when control returns to that function.

Thus, the current function is listed first, and the address of the next instruction to be executed is the current CS:IP address. At the bottom is the main function of your program and the address of the next instruction to be executed when execution returns to the main function.

For each function, the command shows argument values in the current radix in parentheses after the function name.

You can use the address displayed for each line of the stack trace as an argument to the View Source (**VS**) or Unassemble (**U**) commands to see the code at the point where each function is called.

**Mouse and Keyboard**

In addition to typing the (**K**) command, you can use the Calls menu to see the stack trace.

**Remarks** The term “stack trace” is used because as each function is called, its address and arguments are stored on or pushed onto the program stack. CodeView traces through the program stack to find out which functions were called. With C programs, the function **main** is always at the bottom of the stack.

The Stack Trace (**K**) command does not display anything until the program executes the beginning of the main function. The main function sets up the stack trace through frame pointers (the BP register), which CodeView uses to locate parameters, local variables, and return addresses.

If the main module is written in assembly language, the program must execute at least to the beginning of the first procedure called. In addition, your procedures must follow the standard Microsoft calling conventions.

**Example** The following example shows the functions executed in a program so far, where hexadecimal is the current radix under CodeView:

```
>K
convert(0x3:0x17FC,1,2) address 1:ada
make_header(0x3:0x17FC) address 1:314
main(4,0x3:0x181E) address 1:c98
>
```

Here, `convert` is the currently executing function, at address ADA. It is passed three parameters: a pointer and two integers. When it returns control to `make_header`, the program is executing at address 314. When `make_header` returns, the program is executing at address C98.

---

## L (Restart)

**Syntax** **L** [*arguments*]

**Parameter** *arguments*  
New arguments to the program. No other CodeView commands may be specified after the Restart command. They are interpreted as additional program arguments.

**Description** The Restart (**L**) command resets execution to the beginning of the program and optionally sets a new program command line.

After you issue the Restart command:

- ◆ The program's variables are reinitialized.
- ◆ The program's instructions are reset. Any modifications you may have made to the code with the Assemble (**A**), Memory Enter (**ME**), Memory Fill (**MF**), or View Memory (**VM**) commands are lost.
- ◆ Any existing breakpoints or watch statements are retained. The pass counts for all breakpoints are reset.

Used alone, the Restart command keeps the previous command-line arguments specified for your program. You can change the command-line arguments using the Restart command followed by any new arguments to your program.

You can use Restart any time execution has stopped: at any kind of breakpoint, while single-stepping, or when execution is complete.

#### Mouse and Keyboard

In addition to typing the **L** command, you can also restart from the Run menu by choosing Restart. To set a new command line and restart the program, choose Set Runtime Arguments from the Run menu. There is no keyboard shortcut.

#### Remarks

The Restart command does not reset system resources, such as open files or video mode, and does not free allocated system objects. If the application redefines interrupts, the system may no longer work correctly.

---

## MC (Memory Compare)

#### Syntax

**MC** *range address*

#### Parameters

*range*

Range of first block of memory.

*address*

Starting address of second block of memory.

#### Description

The Memory Compare (**MC**) command compares the bytes in a given range of memory with the corresponding bytes beginning at another address. If one or more pairs of corresponding bytes do not match, the command displays each pair of mismatched bytes.

You can enter arguments to the Memory Compare (**MC**) command in any radix, but the output of the command is always in hexadecimal.

**Examples**

The following example compares the block of memory from 100 to 1FF with the block from 300 to 3FF. CodeView reports that the third and ninth bytes differ in the two ranges.

```
>MC 100 1FF 300 ;* hexadecimal radix assumed
004E:0102 0A 00 004E:0302
004E:0108 0A 01 004E:0308
>
```

The following example compares the 100 bytes starting at the address of `arr1[[0]]` with the 100 bytes starting at the address of `arr2[[0]]`.

```
>MC arr1[[0]] L 100 arr2[[0]] ;* decimal radix assumed
>
```

Because CodeView produced no output, the first 100 bytes of each array are identical.

---

## MD (Memory Dump)

**Syntax** MD[[*format*]] [[*address|range*]]

**Parameters**

*format*

Specifies the format to dump data. The format can be one of the following:

Specifier	Format
<b>A</b>	ASCII characters
<b>B</b>	Byte (hexadecimal)
<b>C</b>	Code (instructions)
<b>I</b>	Integer (2-byte decimal)
<b>IU</b>	Integer unsigned (2-byte decimal)
<b>IX</b>	Integer hex (2-byte hexadecimal)
<b>L</b>	Long (4-byte decimal)
<b>LU</b>	Long unsigned (4-byte decimal)
<b>LX</b>	Long hex (4-byte hexadecimal)
<b>R</b>	Real (4-byte float)
<b>RL</b>	Real long (8-byte float)
<b>RT</b>	Real ten-byte (10-byte float)

If *format* is not given, the Memory Dump command defaults to the format last used. If never used before, it defaults to an 8-bit dump.



*address*

Starting address of memory to be dumped. This can be any expression that evaluates to an address. The amount of memory dumped depends on the format specified. If *address* is omitted, the Memory Dump command defaults to the byte immediately following the last byte in the previous dump command. If the Memory Dump command was never used before, it defaults to DS:0000.

*range*

Range of memory to be dumped. Maximum range is 32K.

**Description**

The Memory Dump (**MD**) command displays the contents of memory in the command window, using the format you specify. This command can be used with the Redirection commands to send the contents of memory to another device. Use the View Memory (**VM**) command to display the contents of memory in a separate window.

The Memory Dump Code (**MDC**) command is like the Unassemble (**U**) command, except that **MDC** displays instructions in the Command window instead of the active Source window. Although you normally specify a range with the L character, you can also use the I character with **MDC** to specify a range of instructions rather than bytes.

**Examples**

The following example displays 12 instructions starting from the address at line number 32 in the source code:

```
>mdc .32 I 12
```

The following example displays the byte values in the range between DS:0 and DS:1B. The data segment is assumed when no segment is given. ASCII characters are shown on the right.

```
>mdb 0x0 0x1b
0087:0000 00 00 00 00 00 00 00 00 00 4D 53 20 52 75 6E  ....MS Run
0087:000E 2D 54 69 6D 65 20 4C 69 62 72 61 72 79 20  -Time Library
>
```

The following example displays seven elements of `float_array` as 4-byte real values:

```
>mdr float_array[[0]]
0087:0D56 DC 0F 49 40 +3.141593E+000
0087:0D5A A0 17 CE 3F +1.610096E+000
0087:0D5E 66 66 5B C2 -5.485000E+001
0087:0D62 00 00 C0 3F +1.500000E+000
0087:0D66 FF FF 1F 41 +9.999999E+000
0087:0D6A 00 00 00 00 +0.000000E+000
0087:0D6E 00 00 00 00 +0.000000E+000
>
```

## ME (Memory Enter)

**Syntax** `ME`*type* *address* [*list*]

**Parameters**

*type*

Specifies the type of the data to be entered into memory.

Specifier	Type
<b>A</b>	ASCII characters
<b>B</b>	Byte (hexadecimal)
<b>I</b>	Integer (2-byte decimal)
<b>IU</b>	Integer unsigned (2-byte decimal)
<b>IX</b>	Integer hex (2-byte hexadecimal)
<b>L</b>	Long (4-byte decimal)
<b>LU</b>	Long unsigned (4-byte decimal)
<b>LX</b>	Long hex (4-byte hexadecimal)
<b>R</b>	Real (4-byte float)
<b>RL</b>	Real long (8-byte float)
<b>RT</b>	Real ten-byte (10-byte float)

If no *type* is given, the command defaults to the last type used by a Memory Enter (**ME**), a Memory Dump (**MD**), or a View Memory (**VM**) command. If no such commands were used, it defaults to byte-sized data.

*address*

Indicates where the data will be entered. If no segment is given in the address, the data segment (**DS**) is assumed.

*list*

List of data to enter into memory at *address*. These expressions must evaluate to data of the size specified by *type*. If *list* is not given, CodeView prompts for new values.

**Description**

The Memory Enter (**ME**) command enters one or more byte values into memory at a given address.

The command may include a list of expressions separated by spaces. The expressions are evaluated and entered in the current radix. If an invalid value appears in the list, CodeView refuses to enter the invalid value and ignores remaining values. If no list is given, CodeView prompts for new values.

Because it can modify any part of your program's memory, the Memory Enter command can change your program's instructions. The Assemble (**A**) command, however, is better suited to that purpose.

**Mouse and Keyboard**

There is no keyboard shortcut to enter items into memory. You can use the Memory window, however, to alter items in memory.

**Entering Values**

If you do not give a list of expressions in a Memory Enter (**ME**) command, CodeView prompts for a new value at the address you specify by displaying the address and its current value. At this point, you can do one of the following:

- ◆ Replace the value by typing a new value.
- ◆ Skip to the next value by pressing the SPACEBAR. Once you have skipped to the next value, you can change its value or skip again. CodeView will automatically prompt with new addresses as necessary.
- ◆ Return to the preceding value by typing a backslash (\). When you return to the preceding value, CodeView starts a new display line and prompts with the address and current value.
- ◆ Stop entering values and return to the command prompt by pressing ENTER.

**Example** The following example replaces the byte at DS:256 (DS:0100 hexadecimal) with 66 (42 hexadecimal).

```
>MEB 256
3DA5:0100 41 A. 66
>
```

---

## MF (Memory Fill)

**Syntax** MF *range list*

**Parameters**

*range*  
Specifies the range of memory to be filled.

*list*  
List of byte values used to fill *range*.

**Description** The Memory Fill (**MF**) command fills the addresses in the specified range with the byte values specified in the argument list. You can enter byte values using any radix.

The values in the list are repeated until the whole range is filled. Thus, if you specify only one value, the entire range is filled with that same value. If the list has more values than the number of bytes in the range, the command ignores any extra values.

The Memory Fill command provides an efficient way to fill up a block of memory with any values you specify. You can use it to initialize large data areas, such as arrays or structures. Because it can modify any part of your program's memory, the Memory Fill command can change your program's instructions. However, the Assemble (**A**) command is better suited to that purpose.

**Examples** The following example fills 255 (100 hexadecimal) bytes of memory starting at DS:0100 with the value 0; hexadecimal radix is assumed. This command could be used to reinitialize the program's data without having to restart the program.

```
>MF 100 L 100 0
>
```

This next example fills the 100 (64 hexadecimal) bytes starting at `table` with the following hexadecimal byte values: 42, 79, 74. These three values are repeated (42, 79, 74, 42, 79, 74, ) until all 100 bytes are filled; hexadecimal radix is assumed.

```
>MF table L 64 42 79 74
>
```

---

## MM (Memory Move)

**Syntax**            *MM range address*

**Parameters**        *range*  
                      Specifies the range of memory to copy.  
*address*  
                      Destination address to copy the *range*.

**Description**        The Memory Move (**MM**) command copies all the values in one block of memory directly to another block of memory of the same size. All data in the source block is guaranteed to be copied completely over the destination block, even if the two blocks overlap.

When the source is at a higher address than the destination, the Move Memory command copies data starting at the source block's lowest address. When the source is at a lower address, the Memory Move command copies data beginning at the source block's highest address.

You use the Memory Move command to program in Assembly mode (to copy function fragments, for example) or to copy large amounts of data.

**Examples**            In the following example, the block of memory to copy begins with the first element of `array1` and is `array_size` bytes long. It is copied directly to a block of the same size, beginning at the address of the first element of `array2`.

```
>MM array1[[0]] L array_size array2[[0]]
>
```

---

## MS (Memory Search)

**Syntax**            *MS range list*

**Parameters**        *range*  
                      The range of memory to search.

*list*

A list of byte values separated by spaces or commas or an ASCII string delimited by quotation marks.

**Description**

The Memory Search (**MS**) command scans a range of memory for specific byte values. Use this command to test for the presence of certain values within a range of data.

You can specify any number of byte values to the Memory Search command. Unless the list is an ASCII string, each byte value must be separated by a space or a comma.

If the list contains more than one byte value, the Memory Search command looks for a series of bytes that precisely match the order and value of bytes in the list. If the command finds such a series of bytes, it displays the beginning address of that series.

**Examples**

The following example displays the address of each memory location containing the string `error`. The command searched the first 1,500 bytes at the address specified by the variable `buffer`. CodeView found the string at three addresses.

```
>MS buffer L 1500 "error"  
2BBA:0404  
2BBA:05E3  
2BBA:0604  
>
```

The following example displays the address of each memory location that contains the byte value 0A in the range DS:0100 to DS:0200; hexadecimal is assumed to be the default radix. CodeView found the value at two addresses.

```
>MS DS:100 200 A ;* hexadecimal radix assumed  
3CBA:0132  
3CBA:01C2  
>
```

---

## N (Radix)

**Syntax**

**N** [*radix*]

**Parameter**

*radix*

New radix while running CodeView. Can be 8 (octal), 10 (decimal), or 16 (hexadecimal). If omitted, the command displays the current radix.

**Description**

The Radix (**N**) command changes the current radix for entering arguments and displaying the values of expressions. The new radix number can be 8 (octal), 10 (decimal), or 16 (hexadecimal). Binary and other radices are not allowed. With no arguments, the command displays the current operating radix.

---

**Note** Changing the radix does not convert the l-value of displayed expressions, only the r-value.

---

When you start up CodeView, the default radix is 10 (decimal), unless your main program is written with the Microsoft Macro Assembler (MASM). In this case, the default radix is 16 (hexadecimal).

**Remarks**

The following conditions are not affected by the Radix command:

- ◆ The radix for entering a new radix is always decimal.
- ◆ Format specifiers given with the Display Expression (?) command override the current radix.
- ◆ Addresses are always shown in hexadecimal.
- ◆ In Assembly mode, all values are shown in hexadecimal.
- ◆ The display radix for the Memory Dump (**MD**) and Breakpoint Set (**BP**) commands is always hexadecimal if the size is bytes, words, or doublewords; it is always decimal if the size is integers, unsigned integers, short reals, long reals, or 10-byte reals.
- ◆ The input radix for the Memory Enter (**ME**) command's prompt is always hexadecimal if the size is bytes, words, or doublewords; it is always decimal if the size is integers, unsigned integers, short reals, long reals, or 10-byte reals.
- ◆ The current radix is used for all values given as part of a list, except real numbers, which must be entered in decimal.
- ◆ The register display is always in hexadecimal.

**Example**

The following example shows the decimal equivalents of the number 14 in octal and in hexadecimal.

```
>N8
>? 14, i
12
>N16
>? 14, i
20
>
```

Here, the Display Expression (?) command uses the **i** format specifier, which prints a number in decimal regardless of the current radix.

## O (Options)

**Syntax**            **O**[[*option*[[+|-]] ]]  
**OL**[[*scope*]]

**Parameters**      *option*  
 Character indicating the option to be turned on or off.

Specifier	Option
A	Show Status Bar
B	Bytes Coded
C	Case Sense
F	Flip/Swap
H	Horizontal Scroll Bar
L	Show Address
N	Native Mode
S	Symbols
3	386
V	Vertical Scroll Bar

*scope*  
 For the **OL** command, you can specify a scope of variables to display in Local window using one or more of the following:

Specifier	Scope
L	Lexical
F	Function
M	Module
E	Executable
G	Global
*	All of the above

+  
 Turns option(s) on.

-  
 Turns option(s) off.



**Description**

The Options (**O**) command allows you to view or set the state of the following CodeView options:

Letter	Option	Display
A	Show Status Bar	If on, the status bar appears at the bottom of the screen. If off, the bottommost line becomes part of the window area.
B	Bytes Coded	If on, instruction addresses and machine code are displayed for assembly instructions.
C	Case Sense	If on, symbols are case-sensitive; if off, they are not.
F	Flip/Swap	If on, CodeView flips the program and output screens as the program executes. If off, no screen flipping is performed.
H	Horizontal Scroll Bar	If on, windows have a horizontal scroll bar.
L	Show Address	If on, addresses relative to BP for all local variables are displayed in the Local window.
N	Native Mode	If on, instructions are displayed in the native processor format. If off, p-code instructions are displayed.
S	Symbols	If on, symbols in assembly instructions appear in symbolic form. If off, they appear as addresses.
3	386	If on, registers appear in wide 80386 format, and you can assemble and execute instructions that reference 32-bit registers and memory.
V	Vertical Scroll Bar	If on, windows have a vertical scroll bar.

The Local window always displays variables local to the current routine. You can specify a scope of additional variables to display in the Local window with **OL** form of the Options command. Using **OL** with no options displays the current scope setting for the Local window.

The **O** form of the command (all options) takes no arguments; it displays the state of all options. The other forms of the command (**OF**, **OB**, **OC**, **OS**, **OL**, **O3**, **OA**, **ON**, **OH**, and **OV**) can be used as follows:

- ◆ With no arguments. The state of the option is displayed.
- ◆ With the + or – argument. The + argument turns the option on; the – argument turns the option off.

**Mouse and Keyboard**

As an alternative to typing the **O** command, you can view and set options on the Options menu.

**Remarks** Use the Options (**O**) command to set options when you first start CodeView. You can set these options in the following ways:

- ◆ Give one or more **O** commands with the **/C** option on the CodeView command line or include a similar command line in the CodeView response file.
- ◆ Give one or more **O** commands as the **Autostart** entry in the TOOLS.INI file.

**Example** In the following example, the **O** command is used to display current option settings. Then, the **O3** and **OF** commands are used to display and set options for 386 mode and for screen flip/swap mode. Finally, the **OL** command turns on symbol addresses in the Local window and displays not only local variables but global variables as well.

```
>O
Flip/Swap On
Bytes Coded On
Case Sense On
Show Symbol Address On
Symbols Off
Vertical scroll bar On
Horizontal scroll bar On
Status bar On
>O3
386 Off
>O3+
386 On
>OF
Flip/Swap On
>OF-
Flip/Swap Off
>OLG+
```

---

## O (Port Output)

**Syntax** **O** *port byte*

**Parameters** *port*  
A 16-bit port address.  
*byte*  
Byte to send to *port*.

**Description** The Port Output (**O**) command sends a byte value to a hardware port. You use this command to debug a program that interacts directly with hardware.

The Port Output command is often used with the Port Input (**I**) command.

**Example** In the following example, the byte value 4F hexadecimal is sent to output port 2F8.

```
>O 2F8 4F ;* hexadecimal radix assumed
>
```

---

## P (Program Step)

**Syntax** P [*count*]

**Parameters** *count*  
Repeat stepping *count* times.

**Description** The Program Step (**P**) command executes the current line (in Source mode) or instruction (in Mixed or Assembly mode), stepping over functions. To trace into functions, use the Trace (**T**) command. If a value for *count* is specified, CodeView steps through *count* lines or instructions. If not, only the current line or instruction is executed.

In Source mode, if the current source line contains a function call, CodeView executes the entire function and is ready to execute the line after the call.

In Mixed or Assembly Mode, if the current instruction is CALL, INT, or REP, CodeView executes the entire procedure, interrupt, or repeated string sequence.

**Mouse and Keyboard** In addition to typing the **P** command, you can step through a program using the following shortcuts:

- ◆ Click the <F10=Step> button in the status bar to step once.
- ◆ Press F10 to step once.

---

## Q (Quit)

**Syntax** Q

**Description** The Quit (**Q**) command terminates CodeView and returns control to the environment from which CodeView was invoked: Programmer's WorkBench (PWB), Windows, or the operating system.

CodeView always saves state information on exit.

**Mouse and Keyboard** As an alternative to typing the **Q** command, choose Exit from the File menu. There is no keyboard shortcut.

## R (Register)

**Syntax**            **R** [*register* [[**[[=]]***expression*]] ]

**Parameters**        *register*

Change the contents of the given register. If omitted, displays the values of all registers and flags and the current machine instruction.

**[[=]]***expression*

Assign the value of the expression to the specified register. The equal sign (=) is optional; a space has the same effect.

**Description**

The Register (**R**) command displays and changes the values in the CPU registers. To display register contents without changing them, type the Register (**R**) command without any arguments. This form of the command shows the current values of all registers and flags. Flags are shown symbolically. It also shows the current instruction at the address given by CS:IP.

If an operand of the instruction contains memory expressions or immediate data, CodeView evaluates the operand and indicates the value to the right of the instruction. This value is referred to as the “effective address” and is also displayed at the bottom of the Register window.

**Changing Registers**

You can use the **R** command to change the values in CPU registers. Also, you can change the bits in the flag register symbolically without having to compute a value of the register.

### Changing Register Values

To change the value in a register:

1. Type the command letter **R** followed by the name of a register. The register name can be any of the following: AX, BX, CX, DX, CS, DS, SS, ES, SP, BP, SI, DI, IP, or FL (for flags). If you have an 80386/486-based machine and the 386 option is turned on, the register name can be one of the 32-bit register names: EAX, EBX, ECX, EDX, ESP, EBP, ESI, or EDI.

---

**Note** CodeView allows you to load different execution models which may specify a certain set of registers. For example, the valid registers in the p-code model are DS, SS, CS, IP, SP, BP, PQ, TH, and TL.

---

2. CodeView displays the current value of the register and prompts for a new value with a colon (:).
  - ◆ If you only want to examine the value, press ENTER.
  - ◆ If you want to change the value, type an expression (in the current radix) for the value and press ENTER.

- ◆ As an alternative, you can use the Display Expression (?) command to change the value in a register:

*?register=expression*

### Changing Flag Values

To change a flag value:

1. Type the command letter **R** followed by the letters FL.
2. The command displays the value of each flag as a two-letter name. At the end of the list of values, the command prompts for new flags with a dash (-).
3. Type the new values after the dash for the flags you wish to change, then press ENTER.
  - ◆ You can enter flag values in any order. If you do not enter a new value for a flag, it remains unchanged.
  - ◆ If you do not want to change any flags, press ENTER.

---

**Note** If you enter an illegal flag name, CodeView displays an error message. The flags preceding the error are changed; flags at and following the error are not changed.

---

The flag values are:

Flag	Set Symbol	Clear Symbol
Overflow	OV	NV
Direction	DN	UP
Interrupt	EI	DI
Sign	NG	PL
Zero	ZR	NZ
Auxiliary carry	AC	NA
Parity	PE	PO
Carry	CY	NC

### Mouse and Keyboard

As an alternative to typing the **R** command, you can use the Register window to display CPU values. To change CPU values with the Register window, type over the old values.

**Example**

In the following example, the **R** command displays the current registers and CPU flags. Then the **R** command changes the value in the AX register.

```
>R
AX=0005 BX=299E CX=0000 DX=0000 SP=3800 BP=380E SI=0070 DI=40D1
DS=5067 ES=5067 SS=5067 CS=4684 IP=014F
NV UP EI PL NZ NA PO NC
0047:014F 8B5E06      lea    di, [[BP+06]] ss:ff38=299E
>R AX
AX 0005
:3
>
```

## T (Trace)

**Syntax**

**T** [*count*]

**Parameters**

*count*

Repeat tracing *count* times. If omitted, trace once.

**Description**

The Trace (**T**) command executes the current line (in Source mode) or instruction (in Assembly or Mixed mode), tracing into functions or assembly-language CALL instructions. Use the Program Step (**P**) command to execute function calls without tracing into them.

In Source mode, the Trace command traces into functions whose source code is available and executes through those functions whose source is unavailable.

In Assembly or Mixed mode, CodeView always traces into functions. If the current instruction is CALL or INT, CodeView executes the first instruction of the procedure or interrupt. If the current instruction is REP, CodeView executes one iteration of the repeated string sequence.

CodeView executes MS-DOS function calls without tracing into them. CodeView can trace through BIOS calls in Assembly or Mixed mode.

Since the Trace command uses the hardware trace mode of the 8086 family of processors, you can also trace instructions stored in read-only memory (ROM). However, the Program Step command does not work in ROM; in this case, it has the same effect as the Go (**G**) command.

**Mouse and Keyboard**

In addition to typing the **T** command, you can trace once with the following shortcuts:

- ◆ Click the <F8=Trace> button in the status bar.
- ◆ Press F8.

## T (Trace Speed)

<b>Syntax</b>	<b>T</b> {S M F}								
<b>Parameter</b>	{S M F} Specifies the trace speed for the Animate ( <b>E</b> ) command. You can specify the following speeds:								
	<table> <thead> <tr> <th><b>Specifier</b></th> <th><b>Speed</b></th> </tr> </thead> <tbody> <tr> <td><b>S</b></td> <td>Slow (1/2 second between steps)</td> </tr> <tr> <td><b>M</b></td> <td>Medium (1/4 second between steps; default)</td> </tr> <tr> <td><b>F</b></td> <td>Fast (no wait between steps)</td> </tr> </tbody> </table>	<b>Specifier</b>	<b>Speed</b>	<b>S</b>	Slow (1/2 second between steps)	<b>M</b>	Medium (1/4 second between steps; default)	<b>F</b>	Fast (no wait between steps)
<b>Specifier</b>	<b>Speed</b>								
<b>S</b>	Slow (1/2 second between steps)								
<b>M</b>	Medium (1/4 second between steps; default)								
<b>F</b>	Fast (no wait between steps)								
<b>Description</b>	The Trace Speed command controls the speed at which CodeView executes a program with the Animate ( <b>E</b> ) command.								
<b>Mouse and Keyboard</b>	In addition to typing the <b>TS</b> , <b>TM</b> , or <b>TF</b> commands, you can also set the trace speed from the Options menu. There is no keyboard shortcut.								

## U (Unassemble)

<b>Syntax</b>	<b>U</b> [ <i>context</i> ][ <i>address</i> ]
<b>Parameters</b>	<p><i>context</i> Any legal context operator.</p> <p><i>address</i> Shows unassembled instructions starting at this address. If omitted, unassemble at the current CS:IP address.</p>
<b>Description</b>	<p>The Unassemble (<b>U</b>) command displays assembly-language code beginning at the specified address in the active Source window. If you omit an address, the command uses the current CS:IP address. The command changes the Source window to Assembly mode.</p> <p>Setting the Source window display mode to Assembly and giving the Unassemble command with no arguments causes the code to scroll to the next page of assembly-language instructions.</p> <hr/> <p><b>Note</b> If you specify an address that is within an instruction or within program data, CodeView will still attempt to disassemble and display instructions. Instructions that CodeView cannot disassemble are shown as ???.</p>

**Mouse and Keyboard**

As an alternative to typing the **U** command, you can display assembly-language instructions using the following shortcuts:

- ◆ Click the <F3=Src1 Fmt> or <F3=Src2 Fmt> buttons until the active Source window is in Assembly mode.
- ◆ Press F3 until the Source window is in Assembly mode.
- ◆ From the Options menu, choose Source Window. Then set the display mode to Assembly.

Note that with these shortcuts, you cannot specify an address to start showing unassembled instructions.

**Example**

The following example sets the mode of the Source window to Assembly and displays assembly-language instructions beginning at address 0x7:0x11.

```
>U 0x7:0x11  
>
```

---

## USE (Use Language)

**Syntax**

**USE** *evaluator*

**Parameter**

*evaluator*

Selects the specified expression evaluator. If omitted, the command displays the currently selected expression evaluator. You can specify **AUTO** for the evaluator. With this setting, CodeView selects the appropriate expression evaluator based on the extension of the source file.

**Description**

The **USE** command specifies which expression evaluator CodeView is to use while debugging.

**Mouse and Keyboard**

As an alternative to typing the **USE** command, choose the Language command from the Options menu. There is no keyboard shortcut.

**Remarks**

When you switch expression evaluators, CodeView displays expressions in the Local and Watch windows with the nearest equivalent type in the new language. If the new language does not have an equivalent type, the results are unpredictable.



## VM (View Memory)

**Syntax** VM[[*window*]] [[*type*]] [[*address*]] [[*options*]]

**Parameters**

*window*

Specifies the memory window to display or change (1 or 2). If a value for *window* is omitted, the command defaults to the active Memory window or Memory window 1 if no Memory windows are open.

*type*

Specifies the data-type format of the window's display.

Value	Format
<b>A</b>	ASCII characters
<b>B</b>	Byte (hexadecimal)
<b>I</b>	Integer (2-byte decimal)
<b>IU</b>	Integer unsigned (2-byte decimal)
<b>IX</b>	Integer hex (2-byte hexadecimal)
<b>L</b>	Long (4-byte decimal)
<b>LU</b>	Long unsigned (4-byte decimal)
<b>LX</b>	Long hex (4-byte hexadecimal)
<b>R</b>	Real (4-byte float)
<b>RL</b>	Real long (8-byte float)
<b>RT</b>	Real ten-byte (10-byte float)

If *format* is omitted, the command defaults to the last type used by a View Memory (VM) command or to byte-display format if the VM command was never used.

*address*

Starting address of memory to display or any expression that evaluates to an address. If *address* is omitted, the command defaults to the current address in the active Memory window or DS:00 if no Memory windows are open.

*options*

Specifies how to display and update the Memory window's contents.

**/R**[[+|-]]

Raw data display

Option	Description
+	CodeView displays formatted data along with the corresponding bytes in hexadecimal format.
- (default)	CodeView displays only formatted data.

**/L[[+|-]]**

Live expression

Option	Description
--------	-------------

+	Dynamic: CodeView evaluates <i>address</i> at each step and adjusts the Memory window accordingly.
- (default)	Static: CodeView evaluates <i>address</i> only when the command is entered.

**/F[[\*| *length*]]**

Fixed-width data display

Option	Description
--------	-------------

* (default)	CodeView displays as many items as will fit in the window.
<i>length</i>	CodeView displays a fixed number of items on each line. Must be in the range 1–125.

**Description**

The View Memory (**VM**) command displays the contents of memory in a Memory window using the type and format you specify. The Memory window is updated whenever you execute a command. You can modify memory in the window directly by typing over the displayed memory.

If you enter the **VM** command with no arguments and no Memory windows are open, CodeView opens Memory window 1 in the default display format (variable-width byte display at a static address). If you enter the **VM** command with no arguments and at least one Memory window is open, CodeView displays the current settings for the Memory windows in the Command window.

You can directly modify memory using the Memory window. Type over the values displayed in the active Memory window.

To display the contents of memory in the Command window, use the Memory Dump (**MD**) command.

**Mouse and Keyboard**

In addition to typing the **VM** command, you can open and manipulate Memory windows with the following shortcuts:

- ◆ To open a Memory window from the Windows menu, choose Memory 1 or Memory 2.
- ◆ To set display format and enter expressions for a Memory window, choose Memory Window from the Options menu.

You can cycle through the display formats with the following shortcuts:

- ◆ Click the <SH+F3=Mem1 Fmt> or <SH+F3=Mem2 Fmt> buttons in the status bar.
- ◆ Press SHIFT+F3 to cycle forward.

- ◆ Press CTRL+SHIFT+F3 to cycle backward.
- ◆ When the cursor is in the Memory window, press CTRL+O to display the Memory Window Options dialog box.

### Examples

The following example opens Memory window 2 and displays memory in integer format plus the raw bytes that make up the integers, beginning at the address of the variable `myint`.

```
>VM2I /R myint
```

The following example specifies ASCII format for the current Memory window. The memory displayed begins at the string referred to by element `i` of the array `argv`. The expression is live, so the display is updated as `i` changes.

```
>VMA /L *argv[[i]]
```

---

## VS (View Source)

**Syntax** VS[[*window*]] [[*format*]] [[*address*]] [[*option*[[+|-]] ]]...

### Parameters

*window*

Specifies the Source window (1 or 2) to open or make active.

*format*

Specifies the way to display source code as one of the following:

Specifier	Format
+	Display source lines from the source file
-	Display assembly-language instructions
&	Display both source lines and assembly-language instructions

*address*

Address or line number at which to start displaying source code. The address must fall within the executable portion of your program.

[/option[+|-] ]...

Zero or more source display options. The option can be any of the following specifiers:

Specifier	Option
a	Address When turned on (/a[+]), displays the address of each instruction. When turned off (/a-), does not display addresses.
b	Bytes coded When turned on (/b[+]), displays the hexadecimal form of the instructions. When turned off (/b-), does not display the encoded bytes.
c	Case of disassembly When turned on (/c[+]), displays instruction mnemonics and registers in uppercase. When turned off (/c-), displays instruction mnemonics and registers in lowercase.
l	Line-oriented display When turned on (/l[+]), displays mixed source and assembly in source-line order. When turned off (/l-), displays mixed source and assembly in instruction-code order.
s	Symbols in disassembly When turned on (/s[+]), symbols in instructions appear in symbolic form. If turned off (/s-), they appear as addresses.
t	Track current location (CS:IP) When turned on (/t[+]), the Source window follows the thread of execution (CS:IP). When turned off (/t-), the Source window does not automatically scroll to follow the current location.

## Description

CodeView can display two Source windows at the same time. At least one source window must always be open. You can type the **VS 1** or **VS 2** command to make Source window 1 or 2 active. If the Source window you request is not open, CodeView opens it and makes it active.

The Source windows can show code in a number of display modes:

### Source

CodeView displays the lines from your program's source files.

### Assembly

CodeView displays the assembly instructions that make up your program.

### Mixed

CodeView displays each line of your program's source file, followed by the assembly instructions for that line. This ordering can be reversed by turning the Line-Oriented Display option off (/l-).

Source and Mixed modes are available only if the executable file contains debugging information.

---

**Note** Programs that do not contain debugging information are always displayed in Assembly mode.

---

In the Source and Mixed modes, tracing into a function for which no source lines are available, such as a library function, switches the Source window to Assembly mode. Once program execution returns to an area where source lines are available again, CodeView automatically switches back to Source or Mixed mode.

If you specify a line number or an address with the **VS** command, CodeView draws the Source window so that the source line corresponding to the given address appears in the middle of the Source window. If the address is in another file, CodeView loads that file into the Source window. If you specify an address for which there is no corresponding source text (in your program's data, for example), CodeView will respond with an error message.

You can scroll the contents of the active Source window down a page by typing the **VS** command with no arguments. You can also use the Source window scroll bars.

## Mouse and Keyboard

To make a Source window active or to open a Source window:

- ◆ Click anywhere in an open Source window to make it active.
- ◆ Press ALT+3 or ALT+4 to activate or open Source window 1 or 2.
- ◆ From the Windows menu, choose Source 1 or Source 2.

To change the source display mode:

- ◆ Click the <F3=Src1 Fmt> or <F3=Src2 Fmt> buttons in the status bar to cycle through the three modes.
- ◆ Press F3 to cycle forward.
- ◆ Press CTRL+F3 to cycle backward.
- ◆ From the Options menu, choose Source Window to open the Source Window Options dialog box. Under Display Mode, select one of the option buttons.
- ◆ When the cursor is in the Source window, press CTRL+O to display the Source Window Options dialog box.

## Examples

The following example opens Source window 2 in the mixed mode. The display will start at the function `toss_token`.

```
>VS 2 & toss_token
```

The next example changes the display format in Source window 2 to source lines only.

```
>VS 2 +
```

## W? (Add Watch Expression)

**Syntax** `W? expression [, format]`

**Parameters** *expression*  
Expression to add to the Watch window.

*format*  
A CodeView format specifier that indicates the format in which *expression* is displayed.

**Description** The Add Watch Expression (**W?**) command displays one or more specified values in the Watch window. Watch expressions allow you to watch how a variable changes as your program executes. CodeView updates the Watch window each time the value of the watch expression changes during program execution.

The Watch window shows variables in the default format for their types. To display a watch expression in a different format, type a comma after the expression, followed by a CodeView format specifier. You can also cast the expression to the format you want to use.

CodeView always evaluates watch expressions according to the current radix and reevaluates watch expressions if the radix changes.

For relational expressions, the Watch window shows 0 if the expression is false and 1 if the expression is true.

**Mouse and Keyboard** As an alternative to typing the **W?** command, choose the Add Watch command from the Data menu. There is no keyboard shortcut.

Examples	Command	Action
	<code>W? n</code>	Display the value of the variable <code>n</code> in the Watch window.
	<code>W? high * 100</code>	Display the value of 100 times the variable <code>high</code> in the Watch window.
	<code>W? (char *) 0</code>	Display the byte at DS:0. Because 0 is explicitly cast to a pointer type, CodeView treats it as an offset rather than a constant.

## WC (Delete Watch Expression)

<b>Syntax</b>	<i>WC number</i> !
<b>Parameters</b>	<p><i>number</i> Deletes the watch expression with this number.</p> <p>*</p> <p>Deletes all watch expressions.</p>
<b>Description</b>	<p>The Delete Watch Expression (<b>WC</b>) command removes a watch expression from the Watch window.</p> <p>When you set a watch expression, CodeView automatically assigns it a number, starting with 0 for the first watch expression in the window. Use the List Watch (<b>WL</b>) command to view the numbers of current watch statements.</p>
<b>Mouse and Keyboard</b>	<p>In addition to typing the <b>WC</b> command, you can use the following shortcuts to delete watch expressions:</p> <ul style="list-style-type: none"> <li>◆ From the Data menu, choose Delete Watch.</li> <li>◆ Select the Watch window, move the cursor to the watch expression, and press CTRL+Y.</li> </ul>
<b>Examples</b>	<p>The following example deletes watch expression 2 from the Watch window:</p> <pre>&gt;WC 2</pre> <p>The following example deletes all watch expressions from the Watch window:</p> <pre>&gt;WC *</pre>

## WDG (Windows Display Global Heap)

<b>Syntax</b>	<b>WDG</b> [ <i>ghandle</i> ]
<b>Parameter</b>	<p><i>ghandle</i> A handle to a global memory object. The <b>WDG</b> command displays the five memory objects in the global heap, starting at the specified object. The <i>ghandle</i> must be a valid handle to an object allocated on the global heap. If <i>ghandle</i> is not specified, <b>WDG</b> displays the entire global heap.</p>

**Description** Global memory objects are displayed in the order in which Windows manages them, which is typically not in ascending handle order. The output from the **WDG** command has the following format:

**Format** *handle address size PDB locks type owner*

Any field may not be present if that field is not defined for the block.

<b>Field</b>	<b>Description</b>
<i>handle</i>	Value of the global memory block handle.
<i>address</i>	Address of the global memory block.
<i>size</i>	Size of the block in bytes.
<b>PDB</b>	Block owner. If present, indicates that that task's Process Descriptor Block is the owner of the block.
<i>locks</i>	Count of locks on the block.
<i>type</i>	The memory-block type.
<i>owner</i>	The block owner's module name.

---

## WDL (Windows Display Local Heap)

**Syntax** **WDL**

The output from the **WDL** command has the following format:

**Format** *handle address size flags locks type heapttype blocktype*

Any field may not be present if that field is not defined for the block.

<b>Field</b>	<b>Description</b>
<i>handle</i>	Value of the global memory block handle
<i>address</i>	Address of the block
<i>size</i>	Size of the block in bytes
<i>flags</i>	The block's flags
<i>locks</i>	Count of locks on the block
<i>type</i>	The type of the handle
<i>heapttype</i>	The type of heap the block resides in
<i>blocktype</i>	The block's type



## WDM (Windows Display Modules)

**Syntax**                    **WDM**

**Description**              The **WDM** command displays a list of all DLL and application modules loaded by Windows. Each line of the display has the following format:

**Format**                    *handle refcount module path*

Field	Description
<i>handle</i>	The module handle
<i>refcount</i>	The number of times the module has been loaded
<i>module</i>	The name of the module
<i>path</i>	The path of the module's executable file

## WGH (Windows Dereference Global Handle)

**Syntax**                    **WGH** *handle*

**Parameter**                *handle*  
Global memory handle of memory object to convert.

**Description**              To convert a global memory handle to a pointer, use the **WGH** command. **WGH** converts a global memory handle into a near or a far pointer. Use **WLH** to convert local memory handles.

The **WDG** and **WDL** commands convert the handle into a pointer and display the value of the pointer in *segment:offset* format. You can then use that value to access the memory.

In a Windows-based program, the **GlobalLock** function is used to convert memory handles into near or far pointers. You may know the handle of the memory object, but you might not know what near or far address it refers to unless you are debugging in an area where the program has just called **GlobalLock**.

You use the **WGH** command at any time to find out what the pointer addresses are for global memory handles.

**Example**

The following example is used to display a string in Window's global heap. First, the following code sets up the string:

```
HANDLE hGlobalMem;  
LPSTR lpstr;  
  
hGlobalMem = GlobalAlloc( GMEM_MOVEABLE, 10L )  
lpstr = GlobalLock( hGlobalMem );  
lstrcpy( lpstr, "ABCDEF" );  
GlobalUnlock( hGlobalMem );
```

You can display the contents of the string with the following sequence of commands:

```
>wgh hGlobalMem  
0192:6E30  
>? *(char far*) 0x0192:0x6E30,s
```

---

## WKA (Windows Kill Application)

**Syntax****WKA****Description**

The Windows Kill Application (**WKA**) command terminates the current task by simulating a fatal error.

There may be times when you want to halt your program immediately. You can force an immediate interrupt of a CVW session by pressing CTRL+ALT+SYSREQ. You then have the opportunity to change debugging options, such as setting breakpoints and modifying variables. To resume continuous execution, press F5; to single-step, press F10.

You should take care when you interrupt the CVW session. For example, if you interrupt the session while Windows-based code or other system code is executing, using the Step or Trace functions produces unpredictable results. When you interrupt the CVW session, it is usually safest to set breakpoints in your code and then resume continuous execution rather than using Step or Trace.

If the current code is in your application, you can safely use the **WKA** command without affecting other tasks. However, the **WKA** command does not perform all the cleanup tasks associated with the normal termination of a Windows-based application.

For example, global objects created during the execution of the program but not destroyed before you terminated the program remain allocated in the global heap. This reduces the amount of memory available during the rest of the Windows

operating system session. For this reason, you should use the **WKA** command to terminate the application only if you cannot terminate it normally.

For more information on using the Windows Kill Application (**WKA**) command, see Chapter 10.

---

## WL (List Watch Expressions)

<b>Syntax</b>	<b>WL</b>
<b>Description</b>	The List Watch Expressions ( <b>WL</b> ) command lists all currently set watch expressions along with their numbers and values.
<b>Mouse and Keyboard</b>	As an alternative to typing the <b>WL</b> command, you can use the Watch window to view the current watch expressions.
<b>Example</b>	The following example displays watch expressions and their values:

```
>WL
0) code : 17
1) (float) letters/words : 4.777778
2) lines==11 : 0
>
```

In the example, three watch expressions are set:

1. The variable `code`, which is 17.
2. The arithmetic expression `letters` divided by `words` as a floating point number, currently 4.777778
3. The conditional expression `lines==11`, currently false (zero).

---

## WLH (Windows Dereference Local Handle)

<b>Syntax</b>	<b>WLH</b> <i>handle</i>
<b>Parameter</b>	<i>handle</i> Local memory handle of memory object to convert.
<b>Description</b>	To convert a local memory handle to a pointer, use the Dereference Local Handle ( <b>WLH</b> ) command. <b>WLH</b> converts a local memory handle into a near or a far pointer. Use <b>WGH</b> to convert global memory handles.

The **WDG** and **WDL** commands convert the handle into a pointer and display the value of the pointer in *segment:offset* format. You can then use that value to access the memory.

In a Windows-based program, the **LocalLock** function is used to convert memory handles into near or far pointers. You may know the handle of the memory object, but you might not know what near or far address it refers to unless you are debugging in an area where the program has just called **LocalLock**.

You use the **WLH** command to find out at any time what the pointer addresses are for local memory handles.

### Example

The following example uses **WLH** to refer to an array during a debugging session. First, the following code sets up the array:

```
{
HANDLE      hLocalMem;
int near *  pnArray;
hLocalMem = LocalAlloc( LMEM_MOVEABLE, 100 );
pnArray = LocalLock( hLocalMem );

/* load values into the array */

LocalUnlock( hLocalMem );
. . .
```

Now, after setting a breakpoint immediately after the call to **LocalLock**, the following command displays the array location:

```
>mdw pnArray
```

Outside of this fragment, though, you cannot rely on the value of the `pnArray` variable since the actual data in the memory object may move. Therefore, use the following sequence to display the correct array location:

```
>wlh hLocalMem
0192:100A
>mdw 0192:100A
```

---

## X (Examine Symbols)

**Syntax**            **Xscope** *[[context]][[regex]]*

**Parameters***scope*

Specifies the scope in which to search for symbols. Can be one or more of the following:

Specifier	Scope
L	Lexical
F	Function
M	Module
E	Executable
P	Public
G	Global
*	All of the above

*context*

Specifies context under which to search with the context operator.

*regex*

Specifies a CodeView regular expression.

**Description**

The Examine Symbols (**X**) command displays the names and addresses of symbols and the names of modules defined within a program. You can specify the scope in which to search and a regular expression against which to match symbols. You can further specify a context using the context operator.

For more information on regular expressions, see Appendix B.

**Examples**

The following example shows all the symbols and their addresses in the current lexical scope. The command uses the regular expression `. *` to match any symbol.

```
>XL .*
```

The following example displays all symbols and their addresses in the program that start with `s_`:

```
>XE s_.*
```

## ! (Shell Escape)

**Syntax**

```
![[ [!]command]
```

**Parameter***command*

Executes the given program or operating-system command without leaving CodeView. Use the second exclamation point to return to CodeView immediately after completing *command*.

**Description** The Shell Escape (!) command (CV only) allows you to exit from the CodeView debugger to an MS-DOS shell. You can execute MS-DOS commands or programs from within the debugger, or you can exit from CodeView to MS-DOS while retaining your current debugging context.

If you want to exit to MS-DOS and execute several commands or programs, enter the Shell Escape command with no arguments (!). After the MS-DOS screen appears, you can run internal system commands or programs. When you are ready to return to CodeView, type the command **exit** (in any combination of uppercase and lowercase letters). The debugging screen appears with the same status it had when you left it.

If you want to execute a program or an internal system command from within CodeView, enter the Shell Escape command followed by the name of the command or program you want to execute, as in:

*!command*

The output screen appears, and CodeView executes the command or program. When the output from the command or program is finished, the message

`Press any key to continue...`

appears at the bottom of the screen. Press a key to make the debugging screen reappear with the same status it had when you left it. To suppress this prompt and return directly to CodeView after the command is executed, use two exclamation points (!!)

 for the Shell Escape command.

The Shell Escape command works by executing a second copy of COMMAND.COM.

**Mouse and Keyboard** In addition to typing the ! command, you can also invoke a command shell from the File menu.

**Remarks** Opening a shell requires a significant amount of free memory since the following are all resident in memory:

- ◆ CodeView
- ◆ The debugging information
- ◆ The system's command processor
- ◆ The program being debugged

If your machine does not have enough memory, an error message appears. Even if there is enough memory to start a new shell, there may not be enough memory left to execute large programs from the shell.

In order for you to use the Shell Escape commands, the executable file being debugged must release unneeded memory. Programs created with Microsoft compilers release memory during startup.

Side effects of commands executed while in a shell, such as a change in the working directory, may not be seen when you return to CodeView.

**Example**

In the following example, the shell command **DIR** is executed with the argument `A:*.OBJ`. The directory listing will be followed by the prompt that asks you to press any key:

```
!DIR A:*.OBJ
```

In the following example, the **COPY** command is executed and control returns to CodeView. No prompt appears.

```
!!copy output.txt d:\backup
```

## " (Pause)

**Syntax**           "

**Description**       The Pause (") command interrupts the execution of commands from a redirected file and waits for the user to press a key. Execution of the redirected commands begins as soon as a key is pressed.

**Example**           The following example is from a text file redirected to the CodeView debugger. A Comment (\*) command is used to prompt the user to press a key. The Pause (") command is then used to halt execution until the user responds.

```
* Press any key to continue
'
```

## # (Tab Set)

**Syntax**           *#number*

**Parameter**       *number*  
Number of characters for new tab stops. The valid range for *number* is 1–19.

**Description**       The Tab Set (#) command sets the width in spaces that the CodeView debugger fills for each tab character. The default tab is eight spaces. You can specify values in the range 1–19.

You may want to set a smaller tab size if your source code has so many levels of indentation that source lines extend beyond the edge of the screen.

This command has no effect if your source code contains no tab characters.

---

## \* (Comment)

**Syntax**                *\*comment*

**Description**        The Comment command is an asterisk (\*) followed by text. The CodeView debugger echoes the text of the comment to the screen or other output device. Use this command in combination with the redirection commands when you are:

- ◆ Saving a commented session.
- ◆ Writing a commented session that will be redirected to the debugger.

**Example**                In the following example, the user is sending a copy of a CodeView session to the file OUTPUT.TXT. Comments are added to explain the purpose of the command. The text file will contain commands, comments, and command output.

```
> T>OUTPUT.TXT
> * Dump first 20 bytes of screen buffer
> MDB 0xB800:0 L 20
B800:0000 54 17 6F 17 20 17 72 17 65 17 74 17 75 17 72 17
B800:0010 6E 17 20 17
> >CON
```

---

## . (Current Location)

**Syntax**                .

**Description**        The Current Location (.) command displays the source line or assembly-language instruction corresponding to the current program location. It puts the current program location in the center of the active Source window.

Use this command if you have scrolled the current source line or assembly instruction out of the active Source window.



The Current Location (.) command is equivalent to the command:

```
vs .
```

---

## / (Search)

**Syntax**            / *[[regex]]*

**Parameter**        *regex*  
Searches for the first line containing this regular expression. If omitted, the command searches for the next occurrence of the last regular expression given.

**Description**      The Search (/) command searches for a regular expression in a source file.  
“Regular expressions” are patterns of characters that may match one or many different strings. The use of patterns to match more than one string is similar to the MS-DOS method of using wild card characters in filenames.  
CodeView’s regular expressions use a subset of the UNIX syntax supported by the Programmer’s WorkBench (PWB). For complete information on regular expressions in PWB and CodeView, see Appendix B.

When you enter the Search command with a regular expression, CodeView searches the source file for the first line containing the expression. If you do not give a regular expression, CodeView searches for the next occurrence of the last regular expression specified.

Even if you do not understand regular expressions, you can still use the Search command with plain text strings, since text strings are the simplest form of regular expressions. For example, you can enter

```
>/ COUNT
```

to search for the word COUNT in the source file.

To find strings containing a special regular expression character (. \ ^ \$ \* [ [ ] ), you must precede the character with a backslash (\); this cancels their special meanings. For example, use the command:

```
>/ x\*y
```

to find the string x\*y.

In Source windows, CodeView starts searching at the current cursor position and places the cursor at the line containing the regular expression. The search wraps to the beginning of the file if necessary.

**Mouse and Keyboard**

In addition to typing the / command, you can also search for regular expressions by choosing Find from the Search menu.

**Remarks**

When you search for the next occurrence of a regular expression, CodeView searches to the end of the file, then wraps around and begins again at the start of the file. This search can have unexpected results if the expression occurs only once. For example, when you give the command repeatedly, there is no activity on the screen. Actually, CodeView is repeatedly wrapping around and finding the same expression each time.

The Case Sensitivity command on the Options menu and the Options Case Sense (OC) command affect regular expression searches.

If you want to find a label in your source code, you can also use the View Source (VS) command.

## 7 (8087)

**Syntax**

7

**Description**

The 8087 (7) command dumps the contents of the math processor registers. If you do not have an 8087 or equivalent math processor chip, this command dumps the contents of the software-emulated registers.

**Example**

The following example shows and describes the output from the 7 command:

```
cControl 037F (Closure=Projective Round=nearest, Precision=64-bit )
                    IEM=0 PM=1 UM=1 OM=1 ZM=1 DM=1 IM=1
cStatus 6004 cond=1000 top=4 PE=0 UE=0 OE=0 ZE=1 DE=0 IE=0
Tag      A1FF instruction=59380 operand=59360 op-code=D9EE
Stack    Exp Mantissa      Value
cST(3) special 7FFF 8000000000000000 = + Infinity
cST(2) special 7FFF 0101010101010101 = + Not A Number
cST(1) valid 4000 C90FDAA22168C235 = +3.141592265110390E+000
cST(0) zero 0000 0000000000000000 = +0.000000000000000E+000
```

Here, the lowercase c that precedes several lines of the output indicates that the coprocessor is in use. If this command had been used with an emulated coprocessor, an e would precede the lines. The following is a line-by-line description of the output from the 7 command:

**Line 1**

This line shows the value in the control register, 037F. The rest of the line interprets the bits represented by the number in the control register:

- ◆ The closure method, which can be projective or affine.

- ◆ The rounding method, which can be `nearest (even)`, `down`, `up`, or `chop` (truncate to zero).
- ◆ The precision, which can be 64, 53, or 24 bits.

**Line 2** This line lists the status of the exception-mask bits, described in the following table:

Name	Description
IEM	Interrupt enable
PM	Precision
UM	Underflow
OM	Overflow
ZM	Zero divide
DM	Denormalized operand
IM	Invalid operation

**Line 3** This line lists the value in the status register (6004 hexadecimal), the condition code (1000 binary), and the top of stack register (4 decimal). It then lists the exception flags, described in the following table:

Flag	Meaning
PE	Precision
UE	Underflow
OE	Overflow
ZE	Zero divide
DE	Denormalized operand
IE	Invalid operation

**Line 4** This line lists the 20-bit address of the tag register, the offset of the instruction, the offset of the operand, and the offset of the op-code, all in hexadecimal. When using software-emulated coprocessor routines, this line does not appear.

**Lines 5–9** The rest of the output from the 8087 command lists the contents of the stack register. In this example, `ST(3)` contains the value infinity, `ST(2)` contains a value that cannot be interpreted as any number, `ST(1)` contains a real number, and `ST(0)` contains zero.

## : (Delay)

**Syntax** :

**Description** The Delay (:) command interrupts execution of commands from a redirected file and waits about half a second before continuing. You can put multiple Delay commands on a single line to increase the length of delay. The delay is the same length regardless of the processing speed of the computer.

**Example** In the following example, the Delay (:) command is used to slow execution of the redirected file into CodeView.

```
: ;* That was a short delay...  
::::: ;* That was a longer delay...
```

---

## < (Redirect CodeView Input)

**Syntax** <device

**Parameter** device  
Device or file from which to read commands.

**Description** The Redirect Input (<) command causes CodeView to read all subsequent command input from a file or device.

**Example** The following example redirects command input from the file INFILE.TXT to CodeView. Use this method to run “scripts” of CodeView commands that you have prepared in advance.

```
> <INFILE.TXT
```

You can also start up CodeView with redirected input by typing the following at the operating-system prompt:

```
CV /C"<infile.txt"
```

---

## > (Redirect CodeView Output)

**Syntax** [[T]]>[[>]] device

**Parameter** device  
Device or file to which to write output.

**Description**

The Redirect Output (>) command causes CodeView to write all subsequent command output to a device, such as another terminal, a printer, or a file. The term “output” includes not only output from commands but also the command characters that are echoed as you type them.

The optional **T** indicates that the output should be echoed to the CodeView screen. If you do not give a **T**, CodeView echoes only commands that you enter. Use the **T** option if you are redirecting output to a file to see output from the commands that you are typing.

---

**Note** If you are redirecting output to another terminal, you may not want to see the output on the CodeView terminal.

---

If you specify an existing file, CodeView truncates the file and then starts writing output. To preserve the contents of the file, use a second greater-than symbol (>>), which appends output to the file.

**Example**

In the following example, output is redirected to the device designated as COM1 (for example, a remote terminal). Enter this command when you are debugging a graphics program and you want CodeView commands to be displayed on a remote terminal while the program display appears on the originating terminal.

```
> >COM1
```

In the following example, output is redirected to the file OUTFILE.TXT. Use this command to keep a permanent record of a CodeView session.

```
> T>OUTFILE.TXT
. . .
> >CON
. . .
```

---

**Note** The optional **T** is used so that the session is echoed to the CodeView screen as well as to the file. After redirecting some commands to a file, use the command >CON to return output to the terminal.

---

## = (Redirect CodeView Input and Output)

**Syntax**                *=device*

**Parameter**            *=device*  
Device to which to redirect input and output. Specify >CON for the CodeView Command window.

**Description**            The Redirect Input and Output (=) command causes the CodeView debugger to read all subsequent command input from the device and write all subsequent output to the device. You cannot redirect both input and output to a file.

To reset the input and output for CodeView after you have entered one of the other redirection commands, use the command:

```
>= con
```

---

## ? (Display Expression)

**Syntax**                *? expression[[ ,format]]*

**Parameters**            *expression*  
The expression to display. This can be any valid CodeView expression.  
*,format*  
A CodeView format specifier that indicates the format in which to display *expression*.

**Description**            The Display Expression (?) command displays the value of a CodeView expression. The simplest form of expression is a symbol representing a single variable or function. An expression may also call functions that are part of the executable file.

The Display Expression command can also set values. For example, with the C or C++ expression evaluator, you can increment the variable *n* by using an assignment expression:

```
? n=n+1
```

The command displays the value after incrementing *n*.

You can specify the format in which the values of expressions are displayed by the Display Expression command. After the expression, type a comma, followed by a CodeView format specifier.

**Example**

The following example displays the value stored in the variable `amount`, an integer. This value is first displayed in the system radix (in this case, decimal), then in hexadecimal, then in 4-byte hexadecimal, and then in octal.

```
>? amount
500
>? amount,x
01f4
>? amount,lx
000001f4
>? amount,o
764
>
```

## ?? (Quick Watch)

**Syntax**            *?? symbol*

**Parameter**        *symbol*  
 Displays the given variable, array, or structure in the Quick Watch dialog box.

**Description**      The Quick Watch (??) command displays the value of any selected expression in the Quick Watch dialog box. You can use Quick Watch to quickly check the value of a variable or structure and expand or contract items in a structure.

### Expanding/Contracting Items

The Quick Watch dialog box allows you to:

- ◆ Expand or contract nested structures and arrays.
- ◆ View variables, structures, or arrays addressed by pointers.
- ◆ Add any structure or array to the Watch window.

Expandable items appear with a plus sign (+) in the Quick Watch dialog box. Once expanded, an item appears with a minus sign (-).

Expanding an item has the following effects:

Item	Action
Nested structure	Expands the structure so that the dialog box displays each member of the nested structure.
Pointer	Dereferences the pointer; that is, displays the data that the pointer addresses.
Array	Expands the array so that the dialog box displays each element of the array.

Contracting an item reverses the effects of expanding described above.

---

**Note** You can add any expression in the Quick Watch dialog box to the Watch window by choosing the Add Watch button.

---

### Mouse and Keyboard

After opening the Quick Watch dialog, you can expand or contract an item using the following methods:

- ◆ Double-click the left mouse button on the item.
- ◆ Select the item, then choose the Expand/Contract button at the bottom of the dialog box.
- ◆ Use the arrow keys to select the item, and press ENTER.

---

## @ (Redraw)

**Syntax** @

**Description** The Redraw (@) command redraws the CodeView screen. Use this command if the output of the program being debugged disturbs the CodeView display.

---

## \ (Screen Exchange)

**Syntax** \

**Description** The Screen Exchange (\) command allows you to switch temporarily from the debugging screen to the output screen. The CodeView debugger uses either screen flipping or screen swapping to store the output and debugging screens.

To return to the CodeView screen, press any key.



P A R T 3

# Compiling and Linking

Chapter 13	Linking Object Files with LINK .....	457
Chapter 14	Creating Module-Definition Files .....	491
Chapter 15	Using EXEHDR .....	513



## CHAPTER 13

# Linking Object Files with LINK

This chapter describes the Microsoft Segmented-Executable Linker (LINK) version 5.31. LINK combines compiled or assembled object files into an executable file. This chapter explains LINK's input syntax and fields and tells how to use options to control LINK.

LINK is distributed in the form of LINK.EXE for MS-DOS. LINK is DOS-extended and uses extended memory if available.

When you link for debugging using the /CO option, LINK calls the CVPACK utility. CVPACK version 4.00 must be available on the path. For more information, see "CVPACK" on page 631.

This version of LINK does not support the Microsoft Incremental Linker (ILINK). The LINK options for incremental linking are no longer supported. If /INCR, /PADC, or /PADD is specified, LINK issues a warning and ignores the option.

## New Features

This version of LINK has several new or changed features. This section summarizes changes in options. Changes in module-definition statements are discussed in Chapter 14.

The following options are new or changed in LINK versions 5.30 and later. For more information about each option, see "LINK Options," page 471.

### **/DOSS[[EG]]**

The minimum unique abbreviation for /DOSSEG option has changed from /DO to /DOSS.

### **/DY[[NAMIC]][[:*number*]]**

The new /DYNAMIC option lets you change the limit of interoverlay calls in an overlaid MS-DOS program.

### **/INC[[REMENTAL]]**

The /INCR option is no longer supported.

**/INF[[ORMATION]]**

The /INFO option gives more detailed output. One new use is to get the number of interoverlay calls needed to specify with the /DYNAMIC option.

**/M[[AP]][:*matype*]]**

The /MAP option has been enhanced. You can get more or less detail in the map file by specifying an optional qualifier.

**/NOPACKC[[ODE]]**

The minimum unique abbreviation for /NOPACKC has changed from /NOP to /NOPACKC to distinguish it from the new /NOPACKF option.

**/NOPACKF[[UNCTIONS]]**

The new /NOPACKF option keeps unreferenced packaged functions.

**/OL[[DOVERLAY]]**

The new /OLDOVERLAY option links an overlaid MS-DOS program using the Static Overlay Manager instead of the MOVE library. This option may not be supported in future versions of LINK.

**/ON[[ERROR]]:N[[OEXE]]**

The /ONERROR:NOEXE option prevents LINK from creating the program output if an error occurs.

**/OV[[ERLAYINTERRUPT]]**

The minimum unique abbreviation for this option has changed from /O to /OV, to distinguish it from the new /OLDOVERLAY option.

**/PACKF[[UNCTIONS]]**

The new /PACKF option removes unreferenced packaged functions.

**/PADC[[ODE]]**

The /PADC option is no longer supported.

**/PADD[[ATA]]**

The /PADD option is no longer supported.

**/PC[[ODE]]**

The new /PCODE option tells LINK to call MPC after linking.

**/PM[[TYPE]]**

The default for the /PM option has changed from **NOVIO** to **PM**.

**/r**

The new /r option tells the linker not to use extended memory.

## Overview

LINK combines 80x86 object files into either an executable file or a dynamic-link library (DLL). The object-file format is the Microsoft Relocatable Object-Module Format (OMF), which is based on the Intel 8086 OMF. LINK uses library files in Microsoft library format.

LINK creates “relocatable” executable files and DLLs. The operating system can load and execute relocatable files in any unused section of memory. LINK can create MS-DOS executable files with up to 1 megabyte of code and data (or up to 16 megabytes when using overlays). It can create segmented-executable files with up to 16 megabytes.

For more information on the OMF, the executable-file format, and the linking process, see the *MS-DOS Encyclopedia*.

When the file (either executable or DLL) is created, you can examine the information that LINK puts in the file’s header by using the Microsoft EXE File Header Utility (EXEHDR). For more information on EXEHDR, see Chapter 15.

The Microsoft Programmer’s WorkBench (PWB) invokes LINK to create the final executable file or DLL. Therefore, if you develop your software with PWB, you might not need to read this chapter. However, the detailed explanations of LINK options might be helpful when you use the LINK Options dialog box in PWB. This information is also available in Help.

The compiler or assembler supplied with your language (CL with C, FL with FORTRAN, ML with MASM) also invokes LINK. You can use most of the LINK options described in this chapter with the compiler or assembler. The Microsoft Advisor has more information about the compilers and assembler; select Help for the appropriate language from the Command Line box of the Help Contents screen.

---

**Note** Unless otherwise noted, all references to “library” in this chapter refer to a static library. This can be either a standard library created by the Microsoft Library Manager (LIB) or an import library created by the Microsoft Import Library Manager (IMPLIB), but not a DLL.

---

## LINK Output Files

LINK can create executable files for MS-DOS or the Windows operating system. The kind of file produced is determined by the way the source code is compiled and the information supplied to LINK. LINK’s output is either an executable file or a DLL. For simplicity, this chapter sometimes refers to this output as the “program” or “main output.” LINK creates the appropriate file according to the following rules:

- ◆ If a .DEF file is specified, LINK creates a segmented-executable file. The type is determined by the EXETYPE and LIBRARY statements.
- ◆ If a .DEF file is not specified, LINK creates an MS-DOS program.

- ◆ If an overlay number is specified in a **SEGMENTS** or **FUNCTIONS** statement, LINK creates an overlaid MS-DOS program. This overrides a conflicting .DEF file specification.
- ◆ If /DYNAMIC or /OLDOVERLAY is specified, or if parentheses are used in the *objects* field, LINK creates an overlaid MS-DOS program. This overrides a conflicting .DEF file specification.
- ◆ If an object file or library module contains an export definition (an EXPDEF record), LINK creates a segmented-executable file. This overrides an overlay specification. The **\_\_export** keyword creates an EXPDEF record in a C program. Microsoft C libraries for protect mode contain EXPDEF records, so linking with a protect-mode default library creates a segmented-executable file.
- ◆ If an import library is specified, LINK creates a segmented-executable file.

LINK can also create a “map” file, which lists the segments in the executable file and can list additional information. The /LINE and /MAP options control the content of the map file.

Other options tell LINK to create other kinds of output files. LINK produces a .COM file instead of an .EXE file when the /TINY option is specified. The combination of /CO and /TINY puts debugging information into a .DBG file. A Quick library results when the /Q option is specified. For more information on these and other options, see “LINK Options” on page 471.

## LINK Syntax and Input

The LINK command has the following syntax:

```
LINK objfiles[[, [exefile]] [[, [mapfile]][[, [libraries]][[, [deffile]] ] ] ] ] [;]
```

The LINK fields perform the following functions:

- ◆ The *objfiles* field is a list of the object files that are to be linked into an executable file or DLL. It is the only required field.
- ◆ The *exefile* field lets you change the name of the output file from its default.
- ◆ The *mapfile* field creates a map file or gives the map file a name other than its default name.
- ◆ The *libraries* field specifies additional (or replacement) libraries to search for unresolved references.
- ◆ The *deffile* field gives the name of a module-definition (.DEF) file.

Fields are separated by commas. You can specify all the fields, or you can leave one or more fields (including *objfiles*) blank; LINK then prompts you for the

missing input. (For information on LINK prompts, see “Running LINK” on page 468.) To leave a field blank, enter only the field’s trailing comma.

Options can be specified in any field. For descriptions of each of LINK’s options, see “LINK Options” on page 471.

The fields must be entered in the order shown, whether they contain input or are left blank. Use a space or plus sign (+) to separate multiple filenames in the *objfiles* and *libraries* fields. A semicolon (;) at the end of the LINK command line terminates the command and suppresses prompting for any missing fields. LINK then assumes the default values for the missing fields.

If your file appears in or is to be created in another directory or device, you must supply the full path. Filenames are not case sensitive. If the filename contains a space (supported on some installable file systems), enclose the name in single or double quotation marks ( ' or " ).

To interrupt LINK and return to the operating-system prompt, press CTRL+C at any time. Under certain circumstances you may need to press ENTER after CTRL+C.

The next five sections explain how to use each of the LINK fields.

## The objfiles Field

The *objfiles* field specifies one or more object files to be linked. At least one filename must be entered. If you do not supply an extension, LINK assumes a default .OBJ extension. If the filename has no extension, add a period (.) to the end of its name.

If you name more than one object file, separate the names with a plus sign (+) or a space. To extend *objfiles* to the following line, type a plus sign (+) as the last character on the current line, then press ENTER, and continue. Do not split a name across lines.

---

**Note** Using a special syntax for the *objfiles* field, you can assign the contents of object files to specific overlays in an MS-DOS program. This syntax, described in documentation for earlier versions of LINK, uses parentheses to place one or more object files in an overlay. This syntax may not be supported in future versions of LINK. For more information about overlays, see your high-level language reference documentation.

---

## How LINK Searches for Object Files

When it searches for object files, LINK looks in the following locations in the order specified:

1. The directory specified for the file (if a path is included). If the file is not in that directory, the search ends.
2. The current directory.
3. Any directories specified in the LIB environment variable.

If LINK cannot find an object file, and a floppy drive is associated with that object file, LINK pauses and prompts you to insert a disk that contains the object file.

## Load Libraries

If you specify a library in the *objfiles* field, it becomes a “load library.” LINK treats a load library like any other object file. It does not search for load libraries in directories named in the *libraries* field. You must specify the library’s filename extension; otherwise, LINK assumes an .OBJ extension.

LINK puts every object module from a load library into the executable file, regardless of whether a module resolves an external reference. The effect is the same as if you had specified all the library’s object-module names in the *objfiles* field.

Specifying a load library can create an executable file or DLL that is larger than it needs to be. (A library named in the *libraries* field adds only those modules required to resolve external references.) However, loading an entire library can be useful when:

- ◆ Repeatedly specifying the same group of object files.
- ◆ Debugging so you can call library routines that would not be included in the release version of the program.

## The exefile Field

The *exefile* field is used to specify a name for the main output file. If you do not supply an extension, LINK assumes a default extension, either .EXE, .COM (when using the /TINY option), .DLL (when using a module-definition file containing a **LIBRARY** statement), or .QLB (when using the /Q option).

If you do not specify an *exefile*, LINK assigns a default name to the main output. This name is the base name of the first file listed in the *objfiles* field (whether it is an object file or a load library), plus the extension appropriate for the type of executable file being created.

LINK creates the main file in the current directory unless you specify an explicit path with the filename.



## The mapfile Field

The *mapfile* field is used to specify a filename for the map file or to suppress the creation of a map file. A map file lists the segments in the executable file or DLL.

You can specify a path with the filename. The default extension is .MAP. Specify NUL to suppress the creation of a map file. The default for the *mapfile* field is one of the following:

- ◆ If this field is left blank on the command line or in a response file, LINK creates a map file with the base name of the *exefile* (or the first object file if no *exefile* is specified) and the extension .MAP. If the field contains a dot (.), the map file is given the base name without an extension.
- ◆ When using LINK prompts, LINK assumes either the default described previously (if an empty *mapfile* field is specified) or NUL .MAP, which suppresses creation of a map file.

To add line numbers to the map file, use the /LINE option. To add public symbols and other information, use the /MAP option. Both /LINE and /MAP force a map file to be created unless NUL is explicitly specified in *mapfile*.

## The libraries Field

You can specify one or more standard or import libraries (not DLLs) in the *libraries* field. If you name more than one library, separate the names with a plus sign (+) or a space. To extend *libraries* to the following line, type a plus sign (+) as the last character on the current line, press ENTER, and continue. Do not split a name across lines. If you specify the base name of a library without an extension, LINK assumes a default .LIB extension.

If no library is specified, LINK searches only the default libraries named in the object files to resolve unresolved references. If one or more libraries are specified, LINK searches them in the order named before searching the default libraries.

You can tell LINK to search additional directories for specified or default libraries by giving a drive name or path specification in the *libraries* field; end the specification with a backslash (\). (If you don't include the backslash, LINK assumes that the specification is for a library file instead of a directory.) LINK looks for files ending in .LIB in these directories.

You can specify a total of 32 paths or libraries in the field. If you give more than 32 paths or libraries, LINK ignores the additional specifications without warning you.

---

**Warning** Library names must be unique. If multiple libraries are specified with the same name but different paths, LINK searches only the first library and ignores references in the other libraries.

---

You might need to specify library names to:

- ◆ Use a default library that has been renamed.
- ◆ Specify a library other than the default named in the object file (for example, a library that handles floating-point arithmetic differently from the default library).
- ◆ Search additional libraries.
- ◆ Find a library that is not in the current directory and not in a directory specified by the LIB environment variable.

## Default Libraries

Most high-level language compilers insert the names of the required language libraries in the object files. (The Microsoft Macro Assembler does not support a default library.) LINK searches for these default libraries automatically; you do not need to specify them in the *libraries* field. The libraries must already exist with the name specified in the object file. Default-library names usually refer to combined libraries built and named during setup; consult your compiler documentation for more information about default libraries.

To make LINK ignore the default libraries, use the /NOD option. This leaves unresolved references in the object files. Therefore, you must use the *libraries* field to specify the alternative libraries that LINK is to search.

## Import Libraries

You can specify import libraries created by the IMPLIB utility anywhere you can specify standard libraries. You can also use the LIB utility to combine import libraries and standard libraries. These combined libraries can then be specified in the *libraries* field. For more information on LIB, see Chapter 17. For information on IMPLIB, see Chapter 20.

## How LINK Resolves References

LINK searches static libraries to resolve external references. A static library is either a standard library created by the LIB utility or an import library created by the IMPLIB utility.

LINK searches object files and libraries for a definition of each external reference. When LINK finds a needed definition in a module in a library, LINK adds the entire module (but not necessarily all modules in the library) to the program.

You provide a library to LINK in the following ways:

- ◆ Specify the name of a library in the *libraries* field.
- ◆ Specify the name of a library as a load library in the *objects* field. A load library adds all its modules to the program. For more information, see “Load Libraries” on page 462.
- ◆ Compile a program that uses the INCLUDELIB directive to specify the libraries you want linked. For more information, see “Associating Libraries with Modules” in Chapter 8 of the *Programmer’s Guide*.
- ◆ Compile a program that uses definitions provided in a default library for that compiler. The compiler places a library comment record in the object file. LINK uses the library named in this record.
- ◆ Embed a library comment record in the object file by using the comment pragma in a C program. This record precedes a record for a default library placed in the object file by the compiler; therefore, LINK looks in this library before it searches a default library named in the same object file.

LINK first looks for a definition in files specified in the *objects* field, then it looks in libraries specified in the *libraries* field. The search order is the order in which the files are specified in the fields. LINK then looks in libraries specified in comment records in the object files, again in the specified order.

If LINK cannot find a needed definition, it issues an error message:

```
unresolved external
```

If a reference is defined in more than one library, LINK uses the first definition it finds as it searches the libraries in order. A duplicate definition may not be a problem if the later definition is in a module that is not linked into the program. However, if the duplicate definition is in a module that contains another needed definition, that module is linked into the program, and the duplicate definition causes an error:

```
symbol defined more than once
```

Multiple definitions can also cause a problem if LINK is using extended dictionaries in libraries. An extended dictionary is a summary of the definitions contained in all modules of a library. LINK uses this summary to speed the process of searching libraries. If LINK finds a previously resolved reference listed in an extended dictionary, it assumes that a duplicate definition exists and issues an error message:

```
symbol multiply defined, use /NOE
```

If this error occurs, link your program using the /NOE option.

## How LINK Searches for Library Files

When searching for a library, LINK looks in the following locations in this order:

1. The directory specified for the file, if a path is included. (The default libraries named in object files by Microsoft compilers do not include path specifications.)
2. The current directory.
3. Any directories specified in the *libraries* field.
4. Any directories specified in the LIB environment variable.

If LINK cannot locate a library file, it prompts you to enter the location. The /BATCH option disables this prompting.

### Example

The following is a specification in the *libraries* field:

```
C:\TESTLIB\ NEWLIBV3 C:\MYLIBS\SPECIAL
```

LINK searches NEWLIBV3.LIB first for unresolved references. Since no directory is specified for NEWLIBV3.LIB, LINK looks in the following locations in this order:

1. The current directory
2. The C:\TESTLIB\ directory
3. The directories in the LIB environment variable

If LINK still cannot find NEWLIBV3.LIB, it prompts you with the message:

```
Enter new file spec:
```

Enter either a path to the library or a path and filename for another library.

If unresolved references remain after LINK searches NEWLIBV3.LIB, it then searches the library C:\MYLIBS\SPECIAL.LIB. If LINK cannot find this library, it prompts you as described previously for NEWLIBV3.LIB. If there are still unresolved references, LINK searches the default libraries.

## The deffile Field

Use the *deffile* field to specify a module-definition file. A module-definition file is required for an overlaid MS-DOS program or a DLL. It is optional for a Windows-based application. If you specify a base name with no extension, LINK assumes a .DEF extension. If the filename has no extension, put a period (.) at the end of the name.

By default, LINK assumes that a *deffile* needs to be specified. If you are linking without a .DEF file, use a semicolon to terminate the command line before the *deffile* field (or accept the default NUL.DEF at the Definitions File prompt).

## How LINK Searches for Module-Definition Files

LINK searches for the module-definition file in the following order:

1. The directory specified for the file (if a path is included). If the file is not in that directory, the search terminates.
2. The current directory.

For information on module-definition files, see Chapter 14.

## Examples

The following examples illustrate various uses of the LINK command line.

### Example 1

```
LINK FUN+TEXT+TABLE+CARE, , FUNLIST, FUNPROG.LIB;
```

This command line links the object files FUN.OBJ, TEXT.OBJ, TABLE.OBJ, and CARE.OBJ. By default, the executable file is named FUN.EXE because the base name of the first object file is FUN and no name is specified for the executable file. The map file is named FUNLIST.MAP. LINK searches for unresolved external references in the library FUNPROG.LIB before searching in the default libraries. LINK does not prompt for a .DEF file because a semicolon appears before the *deffile* field.

### Example 2

```
LINK FUN, , ;
```

This command produces a map file named FUN.MAP because a comma appears as a placeholder for the *mapfile* field on the command line.

### Example 3

```
LINK FUN, ;  
LINK FUN;
```

Neither of these commands produces a map file because commas do not appear as placeholders for the *mapfile* field. The semicolon (;) ends the command line and accepts all remaining defaults without prompting; the prompting default for the map file is not to create one.

### Example 4

```
LINK MAIN+GETDATA+PRINTIT, , GETPRINT.LST;
```

This command links the files MAIN.OBJ, GETDATA.OBJ, and PRINTIT.OBJ.

No module-definition file is specified, so if the files are assembled Macro Assembler files, LINK creates an MS-DOS real-mode application. If the files are compiled high-level language files, LINK creates an MS-DOS file if the real-mode default combined libraries are provided or a segmented-executable file if the protect-mode libraries are provided. The map file GETPRINT.LST is created.

### Example 5

```
LINK GETDATA+PRINTIT, , , GETPRINT.DEF
```

This command links GETDATA.OBJ and PRINTIT.OBJ, using the information in GETPRINT.DEF. LINK creates a map file named GETDATA.MAP.

## Running LINK

The simplest use of LINK is to combine one or more object files with a run-time library to create an executable file. You type `LINK` at the command-line prompt, followed by the names of the object files and a semicolon (;). LINK combines the object files with any language libraries specified in the object files to create an executable file. By default, the executable file takes the name of the first object file in the list.

To interrupt LINK and return to the operating-system prompt, press `CTRL+C` at any time. Under certain circumstances you may need to press `ENTER` after `CTRL+C`.

LINK has five input fields, all optional except one (the *objfiles* field). There are several ways to supply the input fields LINK expects:

- ◆ Enter all the required input directly on the command line.
- ◆ Omit one or more of the input fields and respond when LINK prompts for the missing fields.
- ◆ Put the input in a response file and enter the response-file name (preceded by @) in place of the expected input.

These methods can be used in combination. The LINK command line is covered on page 460. The following sections explain the other two methods.

## Specifying Input with LINK Prompts

If any field is missing from the LINK command line and the line does not end with a semicolon, or if any of the supplied fields are invalid, LINK prompts you for the missing or incorrect information. LINK displays one prompt at a time and waits until you respond:

```
Object Modules [.OBJ]:  
Run File [basename.EXE]:  
List File [NUL.MAP]:  
Libraries [.LIB]:  
Definitions File [NUL.DEF]:
```

The LINK prompts correspond to the command-line fields described earlier in this chapter. If you want LINK to prompt you for every input field, including *objfiles*, type the command LINK by itself.

Options can be entered anywhere in any field, before the semicolon if it is specified.

### Defaults

The default values for each field are shown in brackets. Press ENTER to accept the default, or type in the filename(s) you want. The *basename* is the base name of the first object file you specified. To select the default responses for all the remaining prompts and terminate prompting, type a semicolon (;) and press ENTER.

If you specify a filename without giving an extension, LINK adds the appropriate default extension. To specify a filename that does not have an extension, type a period (.) after the name.

Use a space or plus sign (+) to separate multiple filenames in the *objfiles* and *libraries* fields. To extend a long *objfiles* or *libraries* response to a new line, type a plus sign (+) as the last character on the current line and press ENTER. You can continue entering your response when the same prompt appears on a new line. Do not split a filename or a path across lines.

## Specifying Input in a Response File

You can supply input to LINK in a response file. A response file is a text file containing the input LINK expects on the command line or in response to prompts. You can use response files to hold frequently used options or responses or to overcome the 128-character limit on the length of an MS-DOS command line.

## Usage

Specify the name of the response file in place of the expected command-line input or in response to a prompt. Precede the name with an at sign (@), as in:

*@responsefile*

You must specify an extension if the response file has one; there is no default extension. You can specify a path with the filename.

You can specify a response file in any field (either on the command line or after a prompt) to supply input for one or more consecutive fields or all remaining fields. Note that LINK assumes nothing about the contents of the response file; LINK simply reads the fields from the file and applies them in order to the fields for which it has no input. LINK ignores any fields in the response file or on the command line after the five expected fields are satisfied or a semicolon (;) appears.

## Example

The following command invokes LINK and supplies all input in a response file, except the last input field:

```
LINK @input.txt, mydefs
```

## Contents of the Response File

Each input field must appear on a separate line, or separated from other fields on the same line by a comma. You can extend a field to the following line by adding a plus sign (+) at the end of the current line. A blank field can be represented by either a blank line or a comma.

Options can be entered anywhere in any field, before the semicolon if it is specified.

If a response file does not specify all the fields, LINK prompts you for the rest. Use a semicolon (;) to suppress prompting and accept the default responses for all remaining fields.

## Example

```
FUN TEXT TABLE+  
CARE  
/MAP  
FUNLIST  
GRAF.LIB ;
```

If the preceding response file is named FUN.LNK, the command

```
LINK @FUN.LNK
```



causes LINK to:

- ◆ Link the four object files FUN.OBJ, TEXT.OBJ, TABLE.OBJ, and CARE.OBJ into an executable file named FUN.EXE. (Since options can be entered anywhere in any field, /MAP is in the field that would otherwise be blank to accept the .EXE executable-file extension.)
- ◆ Include public symbols and addresses in the map file.
- ◆ Make the name of the map file FUNLIST.MAP.
- ◆ Link any needed routines from the library file GRAF.LIB.
- ◆ Assume no module-definition file.

## LINK Options

This section explains how to use options to control LINK's behavior and modify LINK's output. It contains a brief introduction on how to specify options followed by a description of each option.

## Specifying Options

The following paragraphs discuss rules for using options.

### Syntax

All options begin with a slash (/). (A dash, -, is not a valid option specifier for LINK.) You can specify an option with its full name or an abbreviation, up to the shortest sequence of characters that uniquely identifies the option (except for /DOSSEG). The description for each option shows the minimum legal abbreviation with the optional part enclosed in double brackets. No gaps or transpositions of letters are allowed. For example,

`/B[[ATCH]]`

indicates that either /B or /BATCH can be used, as can /BA, /BAT, or /BATC. Option names are not case sensitive (except for /r), so you can also specify /batch or /Batch. This chapter uses meaningful yet legal forms of the option names. If an option is followed by a colon (:) and an argument, no spaces can appear before or after the colon.

### Usage

LINK options can appear on the command line, in response to a prompt, or as part of a field in a response file. They can also be specified in the LINK environment variable. (For more information, see "Setting Options with the LINK Environment Variable" on page 488.) Options can appear in any field before the last input, except as noted in the descriptions.

If an option appears more than once (for example, on the command line and in the LINK variable), the effect is the same as if the option was given only once. If two options conflict, the most recently specified option takes effect. This means that a command-line option or one given in response to a prompt overrides one specified in the LINK environment variable. For example, the command-line option /SEG:512 cancels the effect of the environment-variable option /SEG:256.

## Numeric Arguments

Some LINK options take numeric arguments. You can enter numbers either in decimal format or in standard C-language notation.

## The /ALIGN Option

**Option**            /A[[LIGNMENT]]:*size*

The /ALIGN option aligns segments in a segmented-executable file at the boundaries specified by *size*. LINK ignores /ALIGN for MS-DOS programs.

The alignment size is in bytes and must be an integer power of two. LINK rounds up to the next power of two if another value is specified. The default alignment is 512 bytes.

This option reduces the size of the file as it is stored on disk by reducing the size of gaps between segments. It has no effect on the size of the file when loaded in memory. The size of an executable file is limited to 64K times the alignment.

## The /BATCH Option

**Option**            /B[[ATCH]]

The /BATCH option suppresses prompting for libraries or object files that LINK cannot find. By default, the linker prompts for a new path whenever it cannot find a library it has been directed to use. It also prompts you if it cannot find an object file that it expects to find on a floppy disk. When /BATCH is used, the linker generates an error or warning message (if appropriate). The /BATCH option also suppresses the LINK copyright message and echoed input from response files.

Using this option can cause unresolved external references. It is intended primarily for users who use batch files or makefiles for linking many executable files with a single command and who wish to prevent linker operation from halting.

---

**Note** This option does not suppress prompts for input fields. Use a semicolon (;) at the end of the LINK input to suppress input prompting.

---

## The /CO Option

**Option** /CO[[DEVIEW]]

The /CO option adds Microsoft Symbolic Debugging Information to the executable file. Debugging information can be used with the Microsoft CodeView debugger. If the object files do not contain debugging information (that is, if they were not compiled or assembled using either /Zi or /Zd), this option places only public symbols in the executable file.

You can run the resulting executable file outside CodeView; the debugging data in the file is ignored. However, it increases file size. You should link a separate release version without the /CO option after the program has been debugged.

When /CO is used with the /TINY option, debugging information is put in a separate file with the same base name as the .COM file and with the .DBG extension.

The /CO option is not compatible with the /EXEPACK option for MS-DOS executable files.

## The /CPARM Option

**Option** /CP[[ARMAXALLOC]]:*number*

The /CPARM option sets the maximum number of 16-byte paragraphs needed by the program when it is loaded into memory. MS-DOS uses this value to allocate space for the program before loading it. This option is useful when you want to execute another program from within your program and you need to reserve memory for the program. The /CPARM option is valid only for MS-DOS programs.

LINK normally requests MS-DOS to set the maximum number of paragraphs to 65,535. Since this is more memory than MS-DOS can supply, MS-DOS always denies the request and allocates the largest contiguous block of memory it can find. If the /CPARM option is used, MS-DOS allocates no more space than the option specified. Any memory in excess of that required for the program loaded is free for other programs.

The *number* can be any integer value in the range 1 to 65,535. If *number* is less than the minimum number of paragraphs needed by the program, LINK ignores your request and sets the maximum value equal to the minimum value. This minimum is never less than the number of paragraphs of code and data in the program. To free more memory for programs compiled in the medium and large models, link with /CPARM:1. This leaves no space for the near heap.

---

**Note** You can change the maximum allocation after linking by using the EXEHDR utility, which modifies the executable-file header. For more information on EXEHDR, see Chapter 15.

---

## The /DOSSEG Option

**Option** /DOSS[[EG]]

The /DOSSEG option forces segments to be ordered as follows:

1. All segments with a class name ending in CODE
2. All other segments outside DGROUP
3. DGROUP segments in the following order:
  - a. Any segments of class BEGDATA. (This class name is reserved for Microsoft use.)
  - b. Any segments not of class BEGDATA, BSS, or STACK.
  - c. Segments of class BSS.
  - d. Segments of class STACK.

In addition, the /DOSSEG option defines the following two labels:

```
__edata = DGROUP : BSS
__end   = DGROUP : STACK
```

The variables `__edata` and `__end` have special meanings for Microsoft compilers. It is recommended that you do not define program variables with these names. Assembly-language programs can reference these variables but should not change them.

The /DOSSEG option also inserts 16 null bytes at the beginning of the `_TEXT` segment (if this segment is defined); unassigned pointers point to this area. This behavior of the option is overridden by the /NONULLS option when both are used; use /NONULLS to override the DOSSEG comment record commonly found in standard Microsoft libraries.

This option is principally for use with assembly-language programs. When you link high-level-language programs, a special object-module record in the Microsoft language libraries automatically enables the /DOSSEG option. This option is also enabled by assembly modules that use Microsoft Macro Assembler (MASM) directive **.DOSSEG**.

---

**Note** The minimum abbreviation allowed for this option is /DOSS.

---

## The /DSALLOC Option

**Option** /DS[[ALLOCATE]]

The /DSALLOC option tells LINK to load all data starting at the high end of the data segment. At run time, the data segment (DS) register is set to the lowest data-segment address that contains program data.

By default, LINK loads all data starting at the low end of the data segment. At run time, the DS register is set to the lowest possible address to allow the entire data segment to be used.

The /DSALLOC option is most often used with the /HIGH option to take advantage of unused memory within the data segment. These options are valid only for assembly-language programs that create MS-DOS .EXE files.

## The /DYNAMIC Option

**Option** /DY[[NOMIC]]:*number*

The /DYNAMIC option changes the limit on the number of interoverlay calls in an overlaid MS-DOS program. (For more information on overlays, see your high-level language documentation.) The default limit is 256. The *number* is a decimal integer from 1 to 10,922. Specify a higher *number* to raise the limit if LINK issues the error `too many interoverlay calls`. Lower the limit to create a smaller table of interoverlay calls, saving space in your program.

To determine the most efficient *number*, run LINK using the /INFO option. The displayed information contains the line

```
NUMBER OF INTEROVERLAY CALLS: requested number; generated calls
```

The *number* of interoverlay calls requested is the *number* set by /DYNAMIC or the default of 256. The *calls* number reports the number of interoverlay calls actually generated. For maximum efficiency, run LINK using /INFO, then relink using /DYNAMIC:*calls*.

The /EXEPACK option is ignored for overlaid programs.

## The /EXEPACK Option

**Option** /E[[XEPACK]]

The /EXEPACK option directs LINK to remove sequences of repeated bytes (usually null characters) and to optimize the load-time relocation table before creating the executable file. (The load-time relocation table is a table of references relative to the start of the program, each of which changes when the executable image is loaded into memory and an actual address for the entry point is assigned.)

The `/EXEPACK` option does not always produce a significant saving in disk space and may sometimes actually increase file size. Programs that have a large number of load-time relocations (about 500 or more) and long streams of repeated characters are usually shorter if packed. LINK issues a warning if the packed file is larger than the unpacked file. The time required to expand a packed file may cause it to load more slowly than a file linked without this option.

You cannot debug packed MS-DOS files with CodeView because the unpacker that `/EXEPACK` appends to an MS-DOS program is incompatible with CodeView. In a Windows-based program, the unpacker is in the loader, and there is no conflict with CodeView.

The `/EXEPACK` option is not compatible with the `/HIGH` or `/Q` option. LINK ignores the `/EXEPACK` option for overlaid programs.

## The `/FARCALL` Option

**Option** `/F[[ARCALLTRANSLATION]]`

The `/FARCALL` option directs the linker to optimize far calls to procedures that lie in the same segment as the caller. This can result in slightly faster code; the gain in speed is most apparent on 80286-based machines and later.

The `/FARCALL` option is on by default for overlaid MS-DOS programs and programs created with the `/TINY` option. It is off by default for other programs. If an environment variable (such as `LINK` or `CL`) includes `/FARCALL`, you can use the `/NOFARCALL` option to override it.

A program that has multiple code segments may make a far call to a procedure in the same segment. Since the segment address is the same (for both the code and the procedure it calls), only a near call is necessary. Far calls appear in the relocation table; a near call does not require a table entry. By converting far calls to near calls in the same segment, the `/FARCALL` option both reduces the size of the relocation table and increases execution speed because only the offset needs to be loaded, not a new segment. The `/FARCALL` option has no effect on programs that make only near calls since there are no far calls to convert.

When `/FARCALL` is specified, the linker optimizes code by removing the instruction `call FAR label` and substituting the following sequence:

```
    nop
    push    cs
    call    NEAR label
```

During execution, the called procedure still returns with a far-return instruction. However, because both the code segment and the near address are on the stack, the

far return is executed correctly. The `nop` (no-op) instruction is added so that exactly 5 bytes replace the 5-byte far-call instruction.

There is a small risk with the `/FARCALL` option. If LINK sees the far-call opcode (9A hexadecimal) followed by a far pointer to the current segment, and that segment has a class name ending in `CODE`, it interprets that as a far call. This problem can occur when using `__based (__segname ("_CODE"))` in a C program. If a program linked with `/FARCALL` fails for no apparent reason, try using `/NOFARCALL`.

Assembly-language programs are generally safe for use with the `/FARCALL` option if they do not involve advanced system-level code, such as might be found in operating systems or interrupt handlers. Object modules produced by Microsoft high-level languages are safe from this problem because little immediate data is stored in code segments.

## The /HELP Option

**Option**            `/HE[[LP]]`

The `/HELP` option calls the QuickHelp utility. If LINK cannot find the Help file or QuickHelp, it displays a brief summary of LINK command-line syntax and options. Do not give a filename when using the `/HELP` option.

## The /HIGH Option

**Option**            `/HI[[GH]]`

At load time, the executable file can be placed either as low or as high in memory as possible. The `/HIGH` option causes MS-DOS to place the executable file as high as possible in memory. Without the `/HIGH` option, MS-DOS places the executable file as low as possible. This option is usually used with the `/DSALLOC` option. These options are valid only for assembly-language programs that create MS-DOS .EXE files.

## The /INFO Option

**Option**            `/I[[NFORMATION]]`

The `/INFO` option displays to the standard output information about the linking process, including the phase of linking, the object files being linked, and the library modules used. This option is useful for determining the locations of the object files and modules, the number of segments, and the order in which they are linked.

An important use of `/INFO` is to get the number of interoverlay calls generated. You can then specify this number with the `/DYNAMIC` option.

## The /LINE Option

**Option**                    `/L[[INENUMBERS]]`

The /LINE option adds the line numbers and associated addresses from source files to the map file. The object file must contain line-number information for it to appear in the map file. If the object file has no line-number information, the /LINE option has no effect. (Use the /Zd or /Zi option with Microsoft compilers such as ML, FL, and CL to add line numbers to the object file.) If you also want to add public symbols or other information to the map file, use the /MAP option. For more information on the map file, see the description of /MAP.

The /LINE option causes a map file to be created even if you did not explicitly tell the linker to do so. LINK creates a map file when a filename is specified in the *mapfile* field or when the default map-file name is accepted. (The /MAP option also forces creation of a map file.) For more information, see the description of *mapfile* on page 463.

By default, the map file is given the same base name as the executable file with the extension .MAP. You can override the default name by specifying a new map-file name in the *mapfile* field or in response to the `List File` prompt.

## The /MAP Option

**Option**                    `/M[[AP]][[:{maptype}]]`

The /MAP option controls the information contained in the map file. The /MAP option causes a map file to be created even if you did not explicitly tell the linker to do so.

LINK creates a map file when a filename is specified in the *mapfile* field or when the default map-file name is accepted. (The /LINE option also forces creation of a map file.) For more information, see the description of *mapfile* on page 463.

A map file by default contains only a list of segments. A map file created with /MAP contains public symbols sorted by name and by address, in addition to the segments list. Symbols in C++ appear in the form of decorated names. To add or omit information, specify /MAP followed by a colon (: ) and a *maptype* qualifier:

`A[[DDRESS]]`

Omits the list of public symbols sorted by name.

`F[[ULL]]`

Adds information about each object file's contribution to a segment. Adds undecorated names following the decorated names for C++ symbols in the listings by name and by address.

If you also want to add line numbers to the map file, use the /LINE option.



By default, the map file is given the same base name as the executable file with the extension `.MAP`. You can override the default name by specifying a new map filename in the *mapfile* field or in response to the `List File` prompt.

Under some circumstances, adding symbols slows the linking process. If this is a problem, do not use `/MAP`.

## The /NOD Option

**Option** `/NOD[[EFAULTLIBRARYSEARCH]][[:libraryname]]`

The `/NOD` option tells LINK not to search default libraries named in object files. Specify *libraryname* to tell LINK to exclude only *libraryname* from the search. If you want LINK to ignore more than one library, specify `/NOD` once for each library. To tell LINK to ignore all default libraries, specify `/NOD` without a *libraryname*. For more information, see “Default Libraries” on page 464.

High-level-language object files usually must be linked with a run-time library to produce an executable file. Therefore, if you use the `/NOD` option, you must also use the *libraries* field to specify an alternate library that resolves the external references in the object files. If you compile a program using Microsoft C 7.0 or later and you specify `/NOD`, you must also specify `OLDNAMES.LIB`.

## The /NOE Option

**Option** `/NOE[[XTDICTIONARY]]`

The `/NOE` option prevents the linker from searching extended dictionaries when resolving references. An extended dictionary is a list of symbol locations in a library created with `LIB`. The linker consults extended dictionaries to speed up library searches. Using `/NOE` slows the linker.

When LINK uses extended dictionaries, it gives an error if a duplicate definition is found. Use this option when you redefine a symbol and an error occurs. For more information, see “How LINK Resolves References” on page 464.

## The /NOFARCALL Option

**Option** `/NOF[[ARCALLTRANSLATION]]`

The `/NOFARCALL` option turns off far-call optimization (translation). Far-call optimization is off by default. However, if an environment variable (such as `LINK` or `FL`) includes the `/FARCALL` option, you can use `/NOFARCALL` to override `/FARCALL`.

## The /NOGROUP Option

**Option**                    /NOG[[ROUPASSOCIATION]]

The /NOGROUP option ignores group associations when assigning addresses to data and code items. It is provided primarily for compatibility with early versions of LINK and Microsoft compilers. This option is valid only for assembly-language programs that create MS-DOS programs.

## The /NOI Option

**Option**                    /NOI[[GNORECASE]]

This option preserves case in identifiers. By default, LINK treats uppercase and lowercase letters as equivalent. Thus ABC, Abc, and abc are considered the same name. When you use the /NOI option, the linker distinguishes between uppercase and lowercase and considers these identifiers to be three different names.

In most high-level languages, identifiers are not case sensitive, so this option has no effect. However, case is significant in C. It's a good idea to use this option with C programs to catch misnamed identifiers.

## The /NOLOGO Option

**Option**                    /NOL[[OGO]]

The /NOLOGO option suppresses the copyright message displayed when LINK starts. This option has no effect if not specified first on the command line or in the LINK environment variable.

## The /NONULLS Option

**Option**                    /NON[[ULLSDOSSEG]]

The /NONULLS option arranges segments in the same order they are arranged by the /DOSSEG option. The only difference is that the /DOSSEG option inserts 16 null bytes at the beginning of the \_TEXT segment (if it is defined), but /NONULLS does not insert the extra bytes.

If both the /DOSSEG and /NONULLS options are given, the /NONULLS option takes precedence. Therefore, you can use /NONULLS to override the DOSSEG comment record found in run-time libraries. This option is for segmented-executable files.

## The /NOPACKC Option

**Option** /NOPACKC[[ODE]]

This option turns off code-segment packing. Code-segment packing is on by default for segmented-executable files and for MS-DOS programs created with overlays or with the /TINY option. It is off by default for other MS-DOS programs. If an environment variable (such as LINK or CL) includes the /PACKC option to turn on code-segment packing, you can use /NOPACKC to override /PACKC. For more information on packing, see “The /PACKC Option” on page 482.

---

**Note** The minimum unique abbreviation for /NOPACKC has changed from /NOP to /NOPACKC.

---

## The /NOPACKF Option

**Option** /NOPACKF[[UNCTIONS]]

This option prevents the removal of unreferenced packaged functions. Removal of such definitions (the /PACKF option) is usually on by default. Use /NOPACKF to preserve these definitions. For example, you may want to keep unreferenced code in a debugging version of your program. For more information on /PACKF and packaged functions, see page 484.

## The /OLDOVERLAY Option

**Option** /OL[[DOVERLAY]]

This option links an overlaid MS-DOS program using the Static Overlay Manager instead of the MOVE library. This option may not be supported in future versions of LINK. For information about overlays, see your high-level language documentation.

## The /ONERROR Option

**Option** /ON[[ERROR]]:N[[OEXE]]

The /ONERROR option tells LINK what to do if an error occurs. By default, if certain errors occur, LINK writes an executable file to disk and overwrites any existing file having the same name. The resulting executable file has the error bit set in its header. Specify /ONERROR:NOEXE to prevent such a file from being written to disk and preserve any existing file having the same name. The /ONERROR option can be useful in makefiles.

## The /OV Option

**Option**                    /OV[[ERLAYINTERRUPT]]:*number*

This option sets an interrupt number for passing control to overlays. By default, the interrupt number used for passing control to overlays is 63 (3F hexadecimal). The /OV option allows you to select a different interrupt number. This option is valid only when linking overlaid MS-DOS programs.

The *number* can be any number from 0 to 255, specified in decimal format or in C-language notation. Numbers that conflict with MS-DOS interrupts can be used; however, their use is not advised. You should use this option only when you want to use overlays with a program that reserves interrupt 63 for some other purpose.

---

**Note** The minimum unique abbreviation for /OV has changed from /O to /OV.

---

## The /PACKC Option

**Option**                    /PACKC[[ODE]][[:*number*]]

The /PACKC option turns on code-segment packing. Code-segment packing is on by default for segmented executable files and for MS-DOS programs created with overlays or with the /TINY option. It is off by default for other MS-DOS programs. You can use the /NOPACKC option to override /PACKC.

The linker packs physical code segments by grouping neighboring logical code segments that have the same attributes. Segments in the same group are assigned the same segment address; offset addresses are adjusted accordingly. All items have the same physical address whether or not the /PACKC option is used. However, /PACKC changes the segment and offset addresses so that all items in a group share the same segment.

The *number* specifies the maximum size of groups formed by /PACKC. The linker stops adding segments to a group when it cannot add another segment without exceeding *number*. It then starts a new group. The default segment size without /PACKC (or when /PACKC is specified without *number*) is 65,500 bytes (64K – 36 bytes).

The /PACKC option produces slightly faster and more compact code. It affects only programs with multiple code segments.

Code-segment packing provides more opportunities for far-call optimization (which is enabled with the /FARCALL option). The /FARCALL and /PACKC options together produce faster and more compact code.

Object code created by Microsoft compilers can safely be linked with the /PACKC option. This option is unsafe only when used with assembly-language programs that

make assumptions about the relative order of code segments. For example, the following assembly code attempts to calculate the distance between CSEG1 and CSEG2. This code produces incorrect results when used with /PACKC because /PACKC causes the two segments to share the same segment address. Therefore, the procedure would always return zero.

```
CSEG1      SEGMENT PUBLIC 'CODE'
.
.
.
CSEG1      ENDS

CSEG2      SEGMENT PARA PUBLIC 'CODE'
            ASSUME  cs:CSEG2

; Return the length of CSEG1 in AX

codesize   PROC  NEAR
            mov   ax, CSEG2 ; Load para address of CSEG1
            sub   ax, CSEG1 ; Load para address of CSEG2
            mov   cx, 4     ; Load count
            shl  ax, cl    ; Convert distance from paragraphs
                                ; to bytes
codesize   ENDP

CSEG2      ENDS
```

## The /PACKD Option

**Option**            /PACKD[[ATA]][[:*number*]]

The /PACKD option turns on data-segment packing. The linker considers any segment definition with a class name that does not end in CODE as a data segment. Adjacent data-segment definitions are combined into the same physical segment. The linker stops adding segments to a group when it cannot add another segment without exceeding *number* bytes. It then starts a new group. The default segment size without /PACKD (or when /PACKD is specified without *number*) is 65,536 bytes (64K).

The /PACKD option produces slightly faster and more compact code. It affects only programs with multiple data segments and is valid only for segmented-executable files. It might be necessary to use the /PACKD option to get around the limit of 254 physical data segments per executable file imposed by an operating system. Try using /PACKD if you get the following LINK error:

```
L1073 file-segment limit exceeded
```

This option may not be safe with other compilers that do not generate fixup records for all far data references.

## The /PACKF Option

**Option**            /PACKF[[UNCTIONS]]

The /PACKF option removes unreferenced “packaged functions.” This behavior is the default. However, if an environment variable (such as LINK or CL) includes the /NOPACKF option, you can use /PACKF to override /NOPACKF.

A packaged function is visible to the linker in the form of a COMDAT record. Packaged functions are created when you use the /Gy option on the CL command line (or, in PWB, when you choose Enable Function Level Linking in the Additional Global Options dialog box, which is available from the C or C++ Compiler Options dialog boxes). Member functions in a C++ program are automatically packaged.

If a packaged function is defined but not called, this option removes the function definition from the executable file. /PACKF is not recursive; LINK does not remove any external definitions brought in by the unused packaged function. For more information about packaged functions, see your C or C++ language documentation.

## The /PAUSE Option

**Option**            /PAU[[SE]]

The /PAUSE option pauses the session before LINK writes the executable file or DLL to disk. This option is supplied for compatibility with machines that have two floppy drives but no hard disk. It allows you to swap floppy disks before LINK writes the executable file.

If you specify the /PAUSE option, LINK displays the following message before it creates the main output:

```
About to generate .EXE file
Change diskette in drive letter and press <ENTER>
```

The *letter* is the current drive. LINK resumes processing when you press ENTER.

Do not remove a disk that contains either the map file or the temporary file. If LINK creates a temporary file on the disk you plan to remove, end the LINK session and rearrange your files so that the temporary file is on a disk that does not

need to be removed. For more information on how LINK determines where to put the temporary file, see “LINK Temporary Files” on page 489.

## The /PCODE Option

Option            /PC[[ODE]]

This option tells LINK to call the Make P-Code (MPC) utility after linking. MPC is included with Microsoft C/C++ versions 7.0 and later. If you link a p-code program using LINK instead of CL, you must use /PCODE to generate a valid executable file. The /PCODE option is not compatible with overlays.

## The /PM Option

Option            /PM[[TYPE]]:*type*

This option specifies the type of Windows-based application being generated. The /PM option is equivalent to including a type specification in the **NAME** statement in a module-definition file.

The *type* field can take one of the following values:

### **PM**

The default. Windows-based application. The application uses the API provided by the Windows operating system and must be executed within the Windows operating system. This is equivalent to **NAME WINDOWAPI**.

### **VIO**

Character-mode application to run in a text window in the Windows operating system session. This is equivalent to **NAME WINDOWCOMPAT**.

### **NOVIO**

Character-mode application that must run full screen within the Windows operating system. This is equivalent to **NAME NOTWINDOWCOMPAT**.

## The /Q Option

Option            /Q[[UICKLIBRARY]]

The /Q option directs the linker to produce a “Quick library” instead of an executable file. A Quick library is similar to a standard library because both contain routines that can be called by a program. However, a standard library is linked with a program at link time; in contrast, a Quick library is linked with a program at run time.

When /Q is specified, the *exefile* field refers to a Quick library instead of an application. The default extension for this field is then .QLB instead of .EXE.

Quick libraries can be used only with programs created with Microsoft QuickBasic or early versions of Microsoft QuickC. These programs have the special code that loads a Quick library at run time.

## The /r Option

**Option**                    /r

Prevents LINK from using extended memory with MS-DOS. The /r option must appear first in the options field on the command line and cannot appear in a response file or the LINK environment variable. LINK.EXE is extender-ready and uses extended memory if it exists. This option forces LINK to use only conventional memory. The option name is case sensitive.

For LINK to run in DOS-extended mode, sufficient extended memory must be available. The memory must be provided by one of the following:

- ◆ An MS-DOS Protected-Mode Interface (DPMI) server, such as that provided in an MS-DOS session within the Windows operating system operating in enhanced mode
- ◆ A Virtual Control Program Interface (VCPI) server, such as Microsoft's EMM386.EXE
- ◆ An XMS driver, such as Microsoft's HIMEM.SYS

## The /SEG Option

**Option**                    /SE[[GMENTS]][[:*number*]]

The /SEG option sets the maximum number of program segments. The default without /SEG or *number* is 128. You can specify *number* as any value from 1 to 16,384 in decimal format or C-language notation. However, the number of segment definitions is constrained by available memory.

LINK must allocate some memory to keep track of information for each segment; the larger the *number* you specify, the less free memory LINK has to run in. A relatively low segment limit (such as the 128 default) reduces the chance that LINK will run out of memory. For programs with fewer than 128 segments, you can minimize LINK's memory requirements by setting *number* to reflect the actual number of segments in the program. If a program has more than 128 segments, however, you must set a higher value.

If the number of segments allocated is too high for the amount of memory available while linking, LINK displays the error message:

```
L1054 requested segment limit too high
```

When this happens, try linking again after setting /SEG to a smaller number.



## The /STACK Option

**Option**            `/ST[[ACK]]:number`

The /STACK option lets you change the stack size from its default value of 2048 bytes. The *number* is any positive even value in decimal or C-language notation up to 64K – 2 bytes. If an odd number is specified, LINK rounds up to the next even value. Do not specify /STACK for a DLL.

Programs that pass large arrays or structures by value or with deeply nested subroutines may need additional stack space. In contrast, if your program uses the stack very little, you might be able to save space by decreasing the stack size. If a program fails with a stack-overflow message, try increasing the size of the stack.

---

**Note** You can also use the EXEHDR utility to change the default stack size by modifying the executable-file header. For more information on EXEHDR, see Chapter 15.

---

## The /TINY Option

**Option**            `/T[[INY]]`

The /TINY option produces a .COM file instead of an .EXE file. The default extension of the output file is .COM. When the /CO option is used with /TINY, debug information is put in a separate file with the same base name as the .COM file and with the .DBG extension. LINK uses /FARCALL and /PACKC when /TINY is specified.

Not every program can be linked in the .COM format. The following restrictions apply:

- ◆ The program must consist of only one physical segment. You can declare more than one segment in assembly-language programs; however, the segments must be in the same group.
- ◆ The code must not use far references.
- ◆ Segment addresses cannot be used as immediate data for instructions. For example, you cannot use the following instruction:  

```
mov     ax, CODESEG
```
- ◆ Windows-based programs cannot be converted to a .COM format.

## The /W Option

Option            /W[[ARNFIXUP]]

The /W option issues the L4000 warning when LINK uses a displacement from the beginning of a group in determining a fixup value. This option is provided because early versions of the Windows-based linker (LINK4) performed fixups without this displacement. This option is for linking segmented-executable files.

## The /? Option

Option            /?

The /? option displays a brief summary of LINK command-line syntax and options.

## Setting Options with the LINK Environment Variable

You can use the LINK environment variable to set options that will be in effect each time you link. (Microsoft compilers such as ML, FL, and CL also use the options in the LINK environment variable.)

## Setting the LINK Environment Variable

You set the LINK environment variable with the following operating-system command:

```
SET LINK=options
```

LINK expects to find *options* listed in the variable exactly as you would type them in fields on the command line, in response to a prompt, or in a response file. It does not accept values for LINK's input fields; filenames in the LINK variable cause an error.

### Example

```
SET LINK=/NOI /SEG:256 /CO  
LINK TEST;  
LINK /NOD PROG;
```

In the preceding example, the commands are specified at the system prompt. The file TEST.OBJ is linked using the options /NOI, /SEG:256, and /CO. The file PROG.OBJ is then linked with the option /NOD, in addition to /NOI, /SEG:256, and /CO.

## Behavior of the LINK Environment Variable

You can specify options in the LINK input fields and in the LINK environment variable. LINK reads the options set in the LINK environment variable before it reads options specified in LINK input fields. This priority has the following effects:

- ◆ The option LINK considers to be first is the first one in the LINK environment variable, if set. The /NOLOGO option behaves differently depending on whether or not it is first. However, the /r option cannot be specified in the LINK variable and must be specified first on the command line.
- ◆ An option specified multiple times with different values will get the last value read by LINK. For example, if /SEG:512 is set in an input field, it overrides a setting of /SEG:256 in the LINK variable.
- ◆ For some options, if an option appears in the LINK variable and a conflicting option appears in an input field, the input-field option overrides the environment-variable option. For example, the input-field option /NOPACKC overrides the environment-variable option /PACKC.

## Clearing the LINK Environment Variable

You must reset the LINK environment variable to prevent LINK from using its options. To clear the LINK variable, use the operating-system command:

```
SET LINK=
```

To see the current setting of the LINK variable, type `SET` at the operating-system prompt.

## LINK Temporary Files

LINK uses available memory during the linking session. If LINK runs out of memory, it creates a disk file to hold intermediate files. LINK deletes this file when it finishes.

When the linker creates a temporary disk file, you see the following message:

```
Temporary file tempfile has been created.  
Do not change diskette in drive, letter.
```

In the preceding message, *tempfile* is the name of the temporary file, and *letter* is the drive containing the temporary file. (The second line appears only for a floppy drive.)

After this message appears, do not remove the disk from the drive specified by *letter* until the link session ends. If the disk is removed, the operation of LINK is unpredictable, and you might see the following message:

```
Unexpected end-of-file on scratch file
```

If this happens, run LINK again.

## Location of the Temporary File

If the TMP environment variable defines a temporary directory, LINK creates temporary files there. If the TMP environment variable is undefined or the temporary directory doesn't exist, LINK creates temporary files in the current directory.

## Name of the Temporary File

When running with MS-DOS version 3.0 or later, LINK asks the operating system to create a temporary file with a unique name in the temporary-file directory.

With MS-DOS versions earlier than 3.0, LINK creates a temporary file named VM.TMP. Do not use this name for your files. LINK generates an error message if it encounters an existing file with this name.

# LINK Exit Codes

LINK returns an exit code (also called return code or error code) that you can use to control the operation of batch files or makefiles.

Code	Meaning
0	No error.
2	Program error. Commands or files given as input to the linker produced the error.
4	System error. The linker: <ul style="list-style-type: none"><li>◆ Ran out of space on output files.</li><li>◆ Was unable to reopen the temporary file.</li><li>◆ Experienced an internal error.</li><li>◆ Was interrupted by the user.</li></ul>

## CHAPTER 14

## Creating Module-Definition Files

This chapter describes the contents of a module-definition (.DEF) file. It begins with a brief overview of the purpose of .DEF files. The rest of the chapter discusses each statement in a module-definition file and describes syntax rules, arguments, fields, attributes, and keywords for each statement.

The statements in this chapter are supported by the following utilities:

- ◆ Microsoft Segmented-Executable Linker (LINK) version 5.31
- ◆ Microsoft Import Library Manager (IMPLIB) version 1.40

### New Features

The latest version of the linker and other utilities support the statements and keywords described in this chapter. The following sections introduce features that are new with these versions.

### MS-DOS Programs

You can now use a module-definition file when you link an MS-DOS application. LINK creates an MS-DOS executable file instead of a segmented-executable file if the .DEF file contains any of the following:

- ◆ An **EXETYPE** statement that specifies the type **DOS**
- ◆ A **SEGMENTS** statement that specifies an overlay number
- ◆ A **FUNCTIONS** statement that specifies an overlay number

Other conditions also determine the type of executable file that LINK creates; for details, see “LINK Output Files” on page 459. The only valid statements in a .DEF file for an MS-DOS program are **EXETYPE**, **SEGMENTS**, **FUNCTIONS**, and **INCLUDE**. All other statements are ignored.

## Statements

Following are the new statements and changes to existing statements described in this chapter. For details on each statement, see the reference section of this chapter.

- ◆ The **NAME** statement's default *apptype* is now **WINDOWAPI** (formerly **NOTWINDOWCOMPAT**).
- ◆ The **EXETYPE** statement's default is now **WINDOWS**.
- ◆ **EXETYPE WINDOWS** now assumes **PROTMODE** by default.
- ◆ The **EXETYPE** statement has a new type argument, **DOS**.
- ◆ The new **SECTIONS** and **OBJECTS** keywords are synonyms for the **SEGMENTS** statement.
- ◆ The new **INCLUDE** statement inserts module statements from a separate text file.
- ◆ The new **FUNCTIONS** statement specifies the order in which functions appear in the executable file. It can also assign functions to a specific segment. In an overlaid MS-DOS program, **FUNCTIONS** can specify the overlay in which functions belong.
- ◆ The **SEGMENTS** statement accepts a new argument, **OVL:number**. This argument specifies the overlay in which the segment belongs in an overlaid MS-DOS program.

## Overlays

A new overlay manager, the Microsoft Overlay Virtual Environment (MOVE), replaces the Microsoft Static Overlay Manager. MOVE is supported by high-level programming languages, such as Microsoft C/C++. For information on creating overlaid MS-DOS programs using MOVE, refer to your high-level language reference documentation.

## Overview

A module-definition (.DEF) file is a text file that describes the name, attributes, exports, imports, system requirements, and other characteristics of an application or dynamic-link library (DLL). This file should be used for DLLs and overlaid DOS programs. It is optional (but desirable) for other segmented executable files, such as Windows-based applications, and is usually not necessary for other MS-DOS programs.

You use module-definition files in the following two situations:

- ◆ You can specify a module-definition file in LINK's *deffile* field. The module-definition file gives the LINK utility the information that is necessary for linking the program. For specific information on using a .DEF file when linking, see page 466.
- ◆ You can use the Microsoft Import Library Manager utility (IMPLIB) to create an import library from a module-definition file for a DLL (or from the DLL created by a module-definition file). You then specify the import library in LINK's *libraries* field when linking an application that uses functions and data in the DLL. For information on IMPLIB, see page 652.

---

**Note** The term “function” as used in this chapter refers to any routine for the programming language being used: function, procedure, or subroutine.

---

## Module Statements

A module-definition file contains one or more “module statements.” Each module statement defines an attribute of the executable file, such as its name, the attributes of program segments, and the number and names of exported and imported functions and data. Table 14.1 summarizes the purpose of the module statements and shows the order in which they are discussed in this chapter.

**Table 14.1 Module Statements**

Statement	Purpose
<b>NAME</b>	Names the application (no library created)
<b>LIBRARY</b>	Names the DLL (no application created)
<b>DESCRIPTION</b>	Embeds text in the application or DLL
<b>STUB</b>	Adds an MS-DOS executable file to the beginning of the file
<b>APPLOADER</b>	Replaces the default Windows operating system loader with a custom loader
<b>EXETYPE</b>	Identifies the target operating system
<b>PROTMODE</b>	Specifies a protected-mode Windows-based program
<b>REALMODE</b>	Specifies a real-mode Windows-based program
<b>STACKSIZE</b>	Sets stack size in bytes
<b>HEAPSIZE</b>	Sets local heap size in bytes
<b>CODE</b>	Sets default attributes for all code segments
<b>DATA</b>	Sets default attributes for all data segments
<b>SEGMENTS</b>	Sets attributes for specific segments

**Table 14.1** Module Statements (*continued*)

Statement	Purpose
<b>OLD</b>	Preserves ordinals from a previous DLL
<b>EXPORTS</b>	Defines exported functions
<b>IMPORTS</b>	Defines imported functions
<b>FUNCTIONS</b>	Specifies function order and location
<b>INCLUDE</b>	Inserts a file containing module statements

## Syntax Rules

The syntax rules in this section apply to all statements in a module-definition file. Other rules specific to each statement are described in the sections that follow.

- ◆ Statement and attribute keywords are not case sensitive. User-specified identifiers are case insensitive by default; however, they can be made case sensitive by using **LINK's** (or **IMPLIB's**) **/NOI** option.
- ◆ Use one or more spaces, tabs, or newline characters to separate a statement keyword from its arguments and to separate statements from each other. A colon (**:**) or equal sign (**=**) that designates an argument is surrounded by zero or more spaces, tabs, or newline characters.
- ◆ A **NAME** or **LIBRARY** statement, if used, must precede all other statements.
- ◆ Most statements appear at most once in a file and accept one specification of parameters and attributes. The specification follows the statement keyword on the same or subsequent line(s). If the statement is repeated with a different specification later in the file, the later statement overrides the earlier one.
- ◆ The **INCLUDE** statement can appear more than once in the file. Each statement takes one filename specification.
- ◆ The **SEGMENTS**, **EXPORTS**, **IMPORTS**, and **FUNCTIONS** statements can appear more than once in the file. Each statement can take multiple specifications, which must be separated by one or more spaces, tabs, or newline characters. The statement keyword must appear once before the first specification and can be repeated before each additional specification.
- ◆ Comments in the file are designated by a semicolon (**;**) at the beginning of each comment line. A comment cannot share a line with part or all of a statement, but it can appear between lines of a multiline statement.
- ◆ Numeric arguments can be specified in decimal or in C-language notation.
- ◆ If a string argument matches a reserved word it must be enclosed in double quotation marks (**"**). Reserved words are listed at the end of this chapter.



**Example** The following module-definition file gives a description for a DLL. This sample file includes one comment and five statements.

```
; Sample module-definition file
LIBRARY FIRSTLIB WINDOWAPI
EXETYPE WINDOWS 3.0
CODE PRELOAD MOVABLE DISCARDABLE
DATA PRELOAD SINGLE
HEAPSIZE 1024
```

## The NAME Statement

The **NAME** statement identifies the executable file as an application (rather than a DLL). It can also specify the name and application type. If **NAME** is specified, the **LIBRARY** statement cannot be used. If neither is used, the default is **NAME**, and **LINK** creates an application. The **NAME** or **LIBRARY** statement must precede all other statements.

**Syntax** **NAME** [*appname*] [*apptype*] [**NEWFILES**]

**Remarks** The arguments can appear in any order.

If *appname* is specified, it becomes the name of the application as it is known by the operating system. This name can be any valid filename. If *appname* contains a space (allowed under some installable file systems), begins with a nonalphabetic character, or is a reserved word, enclose *appname* in double quotation marks. The name cannot exceed 255 characters (not including the surrounding quotation marks). If *appname* is not specified, the base name of the executable file becomes the name of the application.

If *apptype* is specified, it defines the type of application. This information is kept in the executable-file header. The *apptype* is one of the following keywords:

### **WINDOWAPI**

The default. Creates a Windows-based application. The application uses the API provided by the Windows operating system and must be executed within the the Windows operating system. This is equivalent to the **LINK** option **/PM:PM**.

### **WINDOWCOMPAT**

Creates a character-mode application to run in a text window within a Windows operating system session. This is equivalent to the **LINK** option **/PM:VIO**.

### **NOTWINDOWCOMPAT**

Creates a character-mode application that must run full screen and cannot run in a text window within the Windows operating system. This is equivalent to the **LINK** option **/PM:NOVIO**.

The **NEWFILES** keyword sets a bit in the file header to notify the loader that the application may be using an installable file system. The synonym **LONGNAMES** is supported for compatibility.

**Example**

The following example assigns the name `calendar` to an application that can run in a text window within the Windows operating system:

```
NAME calendar WINDOWCOMPAT
```

## The LIBRARY Statement

The **LIBRARY** statement identifies the executable file as a DLL. It can also specify the .DLL filename. The **LIBRARY** or **NAME** statement must precede all other statements. If **LIBRARY** is specified, the **NAME** statement cannot be used. If neither is used, the default is **NAME**.

**Syntax**

**LIBRARY** [*libraryname*] [**PRIVATELIB**]

**Remarks**

The arguments can appear in any order.

If *libraryname* is specified, it becomes the base name of the .DLL file. This name can be any valid filename. LINK assumes a .DLL extension whether or not an extension is specified. If *libraryname* contains a space (allowed under some installable file systems), begins with a nonalphabetic character, or is a reserved word, enclose it in double quotation marks (""). The name cannot exceed 255 characters.

The *libraryname* filename overrides a name specified in LINK's *exefile* field.

Specify **PRIVATELIB** to tell the Windows operating system that only one application may use the DLL.

**Example**

The following example assigns the name `calendar` to the DLL being defined.

```
LIBRARY calendar
```

## The DESCRIPTION Statement

The **DESCRIPTION** statement inserts specified text into the application or DLL. This statement is useful for embedding source-control or copyright information into a file.

**Syntax**

**DESCRIPTION** '*text*'

**Remarks**

The *text* is a string of up to 255 characters enclosed in single or double quotation marks (' or "). To include a literal quotation mark in the text, either specify two consecutive quotation marks of the same type or enclose the text with the alternate

type of quotation mark. If a **DESCRIPTION** statement is not specified, the default text is the name of the main output file as specified in LINK's *exefile* field.

You can view this string by using the EXEHDR utility. The string appears in the `Description:` field. For more information, see Chapter 15.

The **DESCRIPTION** statement is different from a comment. A comment is a line that begins with a semicolon (;). LINK does not place comments into the program.

### Example

The following example inserts the text `Tester's Version, Test "A"`, which contains a literal single quotation mark and a pair of literal double quotation marks, into the application or DLL:

```
DESCRIPTION "Tester's Version, Test "A""
```

## The STUB Statement

The **STUB** statement adds an MS-DOS executable file to the beginning of a segmented executable file. The stub is invoked whenever the file is executed under MS-DOS. Usually, the stub displays a message and terminates execution. However, the program can be of any size and may perform other actions. The **STUB** statement is optional; by default, LINK adds a standard stub that is appropriate for the program's **EXETYPE**.

### Syntax

```
STUB {'filename' | NONE}
```

### Remarks

The *filename* specifies the MS-DOS executable file to be added. LINK searches for *filename* first in the current directory and then in directories specified with the `PATH` environment variable. If you specify a path with *filename*, LINK looks only in that location. The *filename* must be enclosed in single or double quotation marks (' or ").

The alternate specification **NONE** prevents LINK from adding a default stub. This saves space in the application or DLL. However, the resulting file will hang the system if loaded under MS-DOS.

### Example

The following example inserts the MS-DOS executable file `STOPIT.EXE` at the beginning of the application or DLL:

```
STUB 'STOPIT.EXE'
```

The file `STOPIT.EXE` is executed when you attempt to run the application or DLL under MS-DOS.

## The APPLOADER Statement

The **APPLOADER** statement tells the linker to replace the default Windows operating system loader with a custom loader. Use **APPLOADER** when you want your Windows-based program to be loaded by a different loader from the one the Windows operating system calls automatically at load time. This statement applies only to Windows-based programs.

**Syntax**

**APPLOADER** [['*loadername*']]

**Remarks**

The *loadername* is an identifier for an externally defined loader. The name is optionally enclosed in single or double quotation marks (' or "). The identifier is an external reference that must be resolved at link time in an object file or static library. It is not case sensitive unless the /NOI option is used with the linker.

When **APPLOADER** appears in a module-definition file, LINK sets a bit in the header of the executable file to tell the Windows operating system that a custom loader is present. At load time, the Windows operating system loads only the first segment of the program and transfers control to that segment.

At link time, LINK creates a new logical segment called **LOADER\_***loadername* and makes it the first physical segment of the program. LINK places the *loadername* function in this segment. Nothing else is contained in **LOADER\_***loadername*; the /PACKC option does not affect this segment.

**Example**

The following statement replaces the default loader with a loader called `__MSLANGLOAD`, which is defined in the Microsoft FORTRAN run-time libraries:

```
APPLOADER __MSLANGLOAD
```

Windows-based programs that use huge arrays will fail unless loaded by the custom loader provided in the default FORTRAN libraries. This statement appears in the default .DEF file used for FORTRAN QuickWin programs.

## The EXETYPE Statement

The **EXETYPE** statement specifies under which operating system the program is to run. This statement provides an additional degree of protection against the program's being run under an incorrect operating system.

**Syntax**

**EXETYPE** [*descriptor*]

---

**Note** For an overlaid MS-DOS program, LINK assumes **EXETYPE DOS**; in that case, this statement is not required. For information on creating an overlaid program, see your high-level language reference documentation.

---

**Remarks**

The *descriptor* sets the target operating system. **EXETYPE** sets bits in the header that can be checked by operating systems. The *descriptor* argument is one of the following keywords:

**WINDOWS** [*version*]

The default. Creates a Windows-based program. If a **STUB** statement is not specified, **WINDOWS** changes the default message to one that is the same as is provided in WINSTUB.EXE. The *version* is optional; for a description, see the next section, “Windows-Based Programming.”

**DOS**

Creates a nonsegmented executable file. For information on how LINK determines the type of executable file, see “LINK Output Files” on page 459.

**UNKNOWN**

Creates a segmented executable file but sets no bits in the header.

**Windows-Based Programming**

The **WINDOWS** descriptor takes an optional version number. The Windows operating system reads this number to determine the minimum version of the Windows operating system needed to load the application or DLL. For example, if 3.0 is specified, the resulting application or DLL can run under the Windows operating system versions 3.0 and later. If *version* is not specified, the default is 3.0. The syntax for *version* is:

```
number[.[number] ]
```

where each *number* is a decimal integer.

In Windows-based programming, use the **EXETYPE** statement with a **REALMODE** statement to specify a Windows-based application or DLL that runs under either real- or protected-mode.

**Example**

The following statement combination defines an application that runs under the Windows operating system version 3.0 in any mode:

```
EXETYPE WINDOWS 3.0
REALMODE
```

## The PROTMODE Statement

The **PROTMODE** statement specifies that the application or DLL runs only under the Windows operating system in protected mode (either standard mode or 386 enhanced mode). **PROTMODE** lets LINK optimize to reduce both the size of the file on disk and its loading time. **PROTMODE** is assumed by **EXETYPE WINDOWS**. To define a program that runs under any Windows operating system

mode, specify **REALMODE**. Note that **PROTMODE** and **REALMODE** are not legal statements if you have set **EXETYPE** to **DOS**.

**Syntax**            **PROTMODE**

## The REALMODE Statement

The **REALMODE** statement specifies that the application runs under the Windows operating system in either real mode or protected mode. By default, **EXETYPE WINDOWS** assumes **PROTMODE**. **PROTMODE** and **REALMODE** are not legal statements if you have set **EXETYPE** to **DOS**.

**Syntax**            **REALMODE**

## The STACKSIZE Statement

The **STACKSIZE** statement specifies the size of the stack in bytes. It performs the same function as **LINK**'s **/STACK** option. If both of these are specified, the **STACKSIZE** statement overrides the **/STACK** option. Do not specify the **STACKSIZE** statement for a DLL.

**Syntax**            **STACKSIZE** *number*

**Remarks**        The *number* must be a positive integer, in decimal or C-language notation, up to 64K (minus 2 bytes). If an odd number is specified, **LINK** rounds up to the next even value.

**Example**         The following example allocates 4096 bytes of stack space:

```
STACKSIZE 4096
```

## The HEAPSIZE Statement

The **HEAPSIZE** statement defines the size of the application or DLL's local heap in bytes. This value affects the size of the default data segment (**DGROUP**). The default without **HEAPSIZE** is that no local heap is created.

**Syntax**            **HEAPSIZE** {*bytes* | **MAXVAL**}

**Remarks**        The *bytes* argument is a positive integer in decimal or C-language notation. The limit is **MAXVAL**; if *bytes* exceeds **MAXVAL**, the excess is not allocated.

**MAXVAL** is a keyword that sets the heap size to 64K minus the size of **DGROUP**.

**Example** The following example sets the local heap to 4000 bytes:

```
HEAPSIZE 4000
```

## The CODE Statement

The **CODE** statement defines the default attributes for all code segments within the application or DLL. The **SEGMENTS** statement can override this default for one or more specific segments.

**Syntax** **CODE** [[*attributes*]]

**Remarks** The *attributes* are one or more optional attributes: *discard*, *executeonly*, *load*, *movable*, and *shared*. Each can appear once, in any order. These attributes are described in “CODE, DATA, and SEGMENTS Attributes” on page 503.

**Example** The following example sets defaults for the program’s code segments:

```
CODE PRELOAD MOVABLE DISCARDABLE
```

## The DATA Statement

The **DATA** statement defines the default attributes for all data segments within the application or DLL. The **SEGMENTS** statement can override this default for one or more specific segments.

**Syntax** **DATA** [[*attribute...*]]

**Remarks** The *attributes* are one or more optional attributes: *instance*, *load*, *movable*, *readonly*, and *shared*. Each can appear once, in any order. These attributes are described in “CODE, DATA, and SEGMENTS Attributes” on page 503. By default, all data segments have the following attributes:

```
SHARED LOADONCALL READWRITE FIXED
```

**Example** The following example defines the application’s data segment so that it cannot be shared by multiple copies of the program and it cannot be written to. By default, the data segment can be read and written to, and a new DGROUP is created for each instance of the application.

```
DATA NONSHARED READONLY
```

## The SEGMENTS Statement

The **SEGMENTS** statement defines the attributes of one or more individual segments in the application or DLL. The attributes specified for a specific segment override the defaults set in the **CODE** and **DATA** statements (except as noted). The total number of segment definitions cannot exceed the number set using LINK's /SEG option. (The default without /SEG is 128.)

The **SEGMENTS** keyword marks the beginning of a section of segment definitions. Multiple definitions must be separated by one or more spaces, tabs, or newline characters. The **SEGMENTS** statement must appear once before the first definition (on the same or preceding line) and can be repeated before each additional definition. **SEGMENTS** statements can appear more than once in the file.

### Syntax

#### **SEGMENTS**

```
[[segmentname[']] [[CLASS 'classname']] [[attributes]]
```

or

```
[[segmentname[']] [[CLASS 'classname']] [[OVL:overlaynumber]]
```

### Remarks

Each segment definition begins with *segmentname* and is optionally enclosed in single or double quotation marks (' or "). The quotation marks are required if *segmentname* is a reserved word.

The **CLASS** keyword optionally specifies the class of the segment. Single or double quotation marks (' or ") are required around *classname*. If you do not use the **CLASS** argument, the linker assumes that the class is **CODE**.

The *attributes* field applies to segmented executable files. This field accepts one or more optional attributes: *discard*, *executeonly*, *load*, *movable*, *readonly*, and *shared*. Each can appear once, in any order. These attributes are described in the next section, "CODE, DATA, and SEGMENTS Attributes." LINK ignores *attributes* if **OVL** is specified.

The **OVL** keyword tells LINK to create an MS-DOS program that contains overlays. If **OVL** is used, LINK assumes **EXETYPE DOS**. An alternate keyword is **OVERLAY**. The *overlaynumber* specifies the overlay in which the segment is to be placed. The value 0 represents the root, and positive decimal numbers through 65,535 represent overlays. By default, a segment is assigned to the root. For more information on overlays, see your high-level language reference documentation.

### Example

The following example specifies segments named *cseg1*, *cseg2*, and *dseg*. The first segment is assigned the class *mycode*; the second is assigned **CODE** by default. Each segment is given different attributes.



```

SEGMENTS
  cseg1 CLASS 'mycode'
  cseg2                               EXECUTEONLY PRELOAD
  dseg  CLASS 'data'   LOADONCALL READONLY

```

## CODE, DATA, and SEGMENTS Attributes

The following attributes apply to the **CODE**, **DATA**, and **SEGMENTS** statements described previously. Refer to “Remarks” in each of the previous sections for the attributes used by each statement. Most attributes are used by all three statements; others are used as noted. Attributes can appear in any order.

Listed with each attribute are keywords that are legal values for that attribute. The attributes and keywords are described, and the defaults are noted. If two segments with different attributes are combined into the same group, **LINK** makes decisions to resolve any conflicts and assumes a set of attributes.

### *discard*

{**DISCARDABLE** | **NONDISCARDABLE**}

Used for **CODE** and **SEGMENTS** statements only. Determines whether a code segment can be discarded from memory to fill a different memory request. If the discarded segment is accessed later, it is reloaded from disk. The default is **NONDISCARDABLE**.

### *executeonly*

{**EXECUTEONLY** | **EXECUTEREAD**}

Used for **CODE** and **SEGMENTS** statements only. Determines whether a code segment can be read as well as executed.

**EXECUTEONLY** specifies that the segment can only be executed. The keyword **EXECUTE-ONLY** is an alternate spelling.

**EXECUTEREAD** (the default) specifies that the segment is both executable and readable. This attribute is necessary for a program to run under the Microsoft CodeView debugger.

### *instance*

{**NONE** | **SINGLE** | **MULTIPLE**}

Used for the **DATA** statement only. Affects the sharing attributes of the default data segment (**DGROUP**). This attribute interacts with the *shared* attribute.

**NONE** tells the loader not to allocate **DGROUP**. Use **NONE** when a DLL has no data and uses an application’s **DGROUP**.

**SINGLE** (the default for DLLs) specifies that one **DGROUP** is shared by all instances of the DLL or application.

**MULTIPLE** (the default for applications) specifies that DGROUP is copied for each instance of the DLL or application.

This attribute and the *shared* attribute interact for data segments. The *shared* attribute has the keywords **SHARED** and **NONSHARED**. If `DATA SHARED` is specified, `LINK` assumes **SINGLE**; if `DATA NONSHARED` is specified, `LINK` assumes **MULTIPLE**. Similarly, `DATA SINGLE` forces **SHARED**, and `DATA MULTIPLE` forces **NONSHARED**.

#### *load*

{**PRELOAD** | **LOADONCALL**}

Used for **CODE**, **DATA**, and **SEGMENTS** statements. Determines when a segment is loaded.

**PRELOAD** specifies that the segment is loaded when the program starts.

**LOADONCALL** (the default) specifies that the segment is not loaded until accessed and only if not already loaded.

#### *movable*

{**MOVABLE** | **FIXED**}

Used for **CODE**, **DATA**, and **SEGMENTS** statements. Determines whether a segment can be moved in memory. This attribute is valid only for a Windows-based DLL or a real-mode Windows-based application. **FIXED** is the default. An alternative spelling for **MOVABLE** is **MOVEABLE**.

#### *readonly*

{**READONLY** | **READWRITE**}

Used for **DATA** and **SEGMENTS** statements only. Determines access rights to a data segment.

**READONLY** specifies that the segment can only be read.

**READWRITE** (the default) specifies that the segment is both readable and writeable.

#### *shared*

{**SHARED** | **NONSHARED**}

Used for real-mode Windows operating system sessions only. Determines whether all instances of the program can share **EXECUTEREAD** and **READWRITE** segments.

**SHARED** (the default for DLLs) specifies that one copy of the segment is loaded and shared among all processes that access the application or DLL. This attribute saves memory and can be used for code that is not self-modifying. An alternate keyword is **PURE**.

**NONSHARED** (the default for applications) specifies that the segment must be loaded separately for each process. An alternate keyword is **IMPURE**.

This attribute and the *instance* attribute interact for data segments. The *instance* attribute has the keywords **NONE**, **SINGLE**, and **MULTIPLE**. If `DATA SINGLE` is specified, `LINK` assumes **SHARED**; if `DATA MULTIPLE` is specified, `LINK` assumes **NONSHARED**. Similarly, `DATA SHARED` forces **SINGLE**, and `DATA NONSHARED` forces **MULTIPLE**.

## The OLD Statement

The **OLD** statement directs the linker to search another DLL for export ordinals. This statement preserves ordinal values used from older versions of a DLL. For more information on ordinals, see the following sections on the **EXPORTS** and **IMPORTS** statements.

Exported names in the current DLL that match exported names in the old DLL are assigned ordinal values from the earlier DLL unless

- ◆ The name in the old module has no ordinal value assigned, or
- ◆ An ordinal value is explicitly assigned in the current DLL.

Only one DLL can be specified; ordinals can be preserved from only one DLL. If an export in the DLL was specified with the **NONAME** attribute, the exported name is not available and its ordinal cannot be preserved. The **OLD** statement has no effect on applications.

**Syntax**            **OLD** '*filename*'

**Remarks**        The *filename* specifies the DLL to be searched. It must be enclosed in single or double quotation marks (' or ").

## The EXPORTS Statement

The **EXPORTS** statement defines the names and attributes of the functions and data made available to other applications and DLLs. It also defines the names and attributes of the functions that run with I/O privilege. By default, functions and data are hidden from other programs at run time. A definition is required for each function or data item being exported.

The **EXPORTS** keyword marks the beginning of a section of export definitions. Multiple definitions must be separated by one or more spaces, tabs, or newline characters. The **EXPORTS** keyword must appear once before the first definition (on the same or preceding line) and can be repeated before each additional definition. **EXPORTS** statements can appear more than once in the file.

Some languages offer a way to export without using an **EXPORTS** statement. For example, in C the `__export` keyword makes a function available from a DLL.

**Syntax****EXPORTS**

```
entryname[[=internalname]] [[@ord[[ nametable]]]] [[NODATA]] [[PRIVATE]]
```

**Remarks**

The *entryname* defines the function or data-item name as it is known to other programs. If the function or data item is in a C++ module, the *entryname* must be specified as a decorated name. For specific information on decorated names, see your C++ language documentation.

The optional *internalname* defines the actual name of the exported function or data item as it appears within the exporting program; by default, this name is the same as *entryname*.

The optional *ord* field defines a function's ordinal position within the module-definition table as an integer from 1 to 65,535. If *ord* is specified, the function can be called by either *entryname* or *ord*. The use of *ord* is faster and can save space.

The *nametable* is one of two optional keywords that determine what happens to *entryname*. By default, with or without *ord*, the *entryname* is placed in the nonresident names table. If the *ord* number is followed by **RESIDENTNAME**, the name is placed in the resident names table. If **NONAME** is specified after *ord*, the *entryname* is discarded from the DLL being created, and the item is exported only by ordinal.

The optional keyword **NODATA** specifies that there is no static data in the function.

The optional keyword **PRIVATE** tells IMPLIB to ignore the definition. **PRIVATE** prevents *entryname* from being placed in the import library. The keyword has no effect on LINK.

**Example**

The following **EXPORTS** statement defines the three exported functions `SampleRead`, `StringIn`, and `CharTest`. The first two functions can be called either by their exported names or by an ordinal number. In the application or DLL where they are defined, these functions are named `read2bin` and `str1`, respectively.

```
EXPORTS
    SampleRead = read2bin @8
    StringIn   = str1      @4 RESIDENTNAME
    CharTest
```

## The IMPORTS Statement

The **IMPORTS** statement defines the names and locations of functions and data items to be imported (usually from a DLL) for use in the application or DLL. A definition is required for each function or data item being imported. This statement is an alternative to resolving references through an import library created by the

IMPLIB utility; functions and data items listed in an import library do not require an **IMPORTS** definition.

The **IMPORTS** keyword marks the beginning of a section of import definitions. Multiple definitions must be separated by one or more spaces, tabs, or newline characters. The **IMPORTS** keyword must appear once before the first definition on the same or preceding line and can be repeated before each additional definition. **IMPORTS** statements can appear more than once in the file.

**Syntax****IMPORTS**

```
[[internalname=]]modulename.entry
```

**Remarks**

The *internalname* specifies the function or data-item name as it is used in the importing application or DLL. Thus, *internalname* appears in the source code of the importing program, while the function may have a different name in the program where it is defined. By default, *internalname* is the same as the *entry* name. An *internalname* is required if *entry* is an ordinal value.

The *modulename* is the filename of the exporting application or DLL that contains the function or data item.

The *entry* argument specifies the name or ordinal value of the function or data item as defined in the *modulename* application or DLL. If *entry* is an ordinal value, *internalname* must be specified. (Ordinal values are set in an **EXPORTS** statement.) If the function or data item is in a C++ module, *entry* must be specified as a decorated name. For information on decorated names, see your C++ language documentation.

---

**Note** A given symbol (function or data item) has a name for each of three different contexts. The symbol has a name used by the exporting program (application or DLL) where it is defined, a name used as an entry point between programs, and a name used by the importing program where the symbol is used. If neither program uses the optional *internalname* argument, the symbol has the same name in all three contexts. If either of the programs uses the *internalname* argument, the symbol may have more than one distinct name.

---

**Example**

The **IMPORTS** statement that follows defines three functions to be imported: `SampleRead`, `SampleWrite`, and a function that has been assigned an ordinal value of 1. The functions are found in the `Sample`, `SampleA`, and `Read` applications or DLLs, respectively. The function from `Read` is referred to as `ReadChar` in the importing application or DLL. The original name of the function,

as it is defined in `Read`, may or may not be known and is not included in the **IMPORTS** statement.

```
IMPORTS
    Sample.SampleRead
    SampleA.SampleWrite
ReadChar = Read.1
```

## The FUNCTIONS Statement

The **FUNCTIONS** statement places high-level language functions in a specified physical order and also assigns them to segments or overlays. For more information on overlays, see your high-level language reference documentation.

**Syntax**            **FUNCTIONS**[[:*{segmentname | overlaynumber}*]]  
*functionname*

**Remarks**        The **FUNCTIONS** keyword marks the beginning of a section of functions. **FUNCTIONS** statements can appear more than once in the `.DEF` file.

**FUNCTIONS** can be followed by a colon (`:`) and a destination specifier, which is either *segmentname* or *overlaynumber*.

The *segmentname* specifies a defined segment in which a function is to be placed. The *segmentname* does not have to be previously defined in a **SEGMENTS** statement. **LINK** assumes the segment definition, using the class **CODE**; a later **SEGMENTS** statement can redefine the segment.

The *overlaynumber* specifies the overlay in which a function is to be placed. Valid overlay numbers are from 0 through 65,535. The number 0 represents the root.

The *functionname* is the identifier for a “packaged function.” A packaged function is visible to the linker in the form of a **COMDAT** record. To compile a C function as a packaged function, use the `/Gy` option on the **CL** command line (or, in [name of IDE], choose Enable Function-Level Linking). Only packaged functions can be specified in a **FUNCTIONS** statement. You can specify one or more function names, separated by one or more spaces, tabs, or newline characters. If the function is in a C++ module, *functionname* must be specified as a decorated name. For specific information on decorated names, see your C++ language documentation.

### Ordering Functions

You can use **FUNCTIONS** to specify a list of ordered functions. **LINK** places ordered functions into a segment in the physical order that you specify before unordered functions in the same segment. You can let **LINK** choose the segment, or you can specify the segment. If **LINK** makes the decision, it places ordered functions in segments called **COMDAT\_SEG $n$** , where  $n$  is one of a sequence of

numbers beginning with 0. As LINK places ordered functions in these segments, it creates a new segment when the current one reaches 64K (minus 36 bytes). You can specify the destination segment in one of two ways:

- ◆ Specify the segment using “explicit allocation.” In explicit allocation, a function is assigned to a segment at compile time, either in the source code or when compiling. In C source code, you can use the **\_\_based** keyword (or its predecessor, the **alloc\_text** pragma) to specify the segment where an individual function is to reside. When compiling with the CL compiler, you can use the **/NT** option to specify the segment where all functions in an object file are to reside. A function not explicitly allocated to a segment is sometimes referred to as an anonymous function.
- ◆ Specify the segment after the **FUNCTIONS** keyword. The segment must already have been defined, either in a **SEGMENTS** statement or at compile time. An explicitly allocated function cannot be placed in a different segment from the one to which it was allocated.

LINK accumulates multiple specifications and treats them as one list of ordered functions. If segments or overlays are specified, LINK accumulates the functions with other functions that have the same destination.

The following statement places three functions in a specified order within the segment called `MySeg`:

```
FUNCTIONS:MySeg
    Func1
    Func2
    Func3
```

### Creating Overlays

You can use **FUNCTIONS** to place a packaged function in an overlay. By default, a function is assigned to the root.

If a function is explicitly allocated (see the previous section), it can be placed in an overlay only if its segment and any other functions in that segment are not also assigned to an overlay. In this case, the **FUNCTIONS** statement implicitly assigns the entire segment to the specified overlay. An explicitly allocated function cannot be placed in a different overlay from the segment to which it is allocated.

For examples of how to use the **FUNCTIONS** statement to create overlays, see your high-level language reference documentation.

## The INCLUDE Statement

The **INCLUDE** statement inserts the contents of a specified text file where it is specified in the .DEF file. The inserted file must contain module statements as they would appear in the .DEF file in which they are being inserted.

**Syntax**                    **INCLUDE** [[']*filename*[']]

**Remarks**                You can specify a path with the filename. Wildcards are not permitted. If *filename* contains a space (allowed under some installable systems), begins with a nonalphabetic character, or is a reserved word, enclose it in single or double quotation marks (' or ").

Multiple **INCLUDE** statements can appear in a .DEF file; each specifies a single insertion. **INCLUDE** statements can be nested up to 10 levels deep.

## Reserved Words

The following words are reserved by the linker for use in module-definition files. These names can be used as arguments in module-definition statements only if the name is enclosed in double quotation marks ("").

ALIAS	EXPANDDOWN	MIXED1632
APPLoader	EXPORTS	MOVABLE
BASECLASS	FIXED	MOVEABLE
CODE	FUNCTIONS	MULTIPLE
CONFORMING	HEAPSIZE	NAME
CONSTANT	HUGE	NEWFILES
CONTIGUOUS	IMPORTS	NODATA
DATA	IMPURE	NOEXPANDDOWN
DESCRIPTION	INCLUDE	NOIOPL
DEV386	INITGLOBAL	NONAME
DEVICE	INITINSTANCE	NONCONFORMING
DISCARDABLE	INVALID	NONDISCARDABLE
DOS	IOPL	NONE
DYNAMIC	LIBRARY	NONPERMANENT
EXECUTE-ONLY	LOADONCALL	NONSHARED
EXECUTEONLY	LONGNAMES	NOTWINDOWCOMPAT
EXECUTEREAD	MACINTOSH	NT
EXETYPE	MAXVAL	NULL



OBJECTS	READONLY	SWAPPABLE
OLD	READWRITE	TERMINSTANCE
OS2	REALMODE	UNIX
OVERLAY	RESIDENT	UNKNOWN
OVL	RESIDENTNAME	VERSION
PERMANENT	SECTIONS	VIRTUAL
PHYSICAL	SEGMENTS	WINDOWAPI
POSIX	SHARED	WINDOWCOMPAT
PRELOAD	SINGLE	WINDOWS
PRIVATELIB	STACKSIZE	WINDOWSCHAR
PROTMODE	STUB	WINDOWSNT
PURE	SUBSYSTEM	



---

## CHAPTER 15

# Using EXEHDR

The Microsoft EXE File Header Utility (EXEHDR) version 3.00 displays the contents of an executable-file header and can be used to alter some fields in the header. You can display or alter headers of MS-DOS programs and segmented-executable files (applications or DLLs). Some header fields have a different meaning in a Windows-based application file; see your Windows operating system documentation for more information. Examples of EXEHDR usage include:

- ◆ Determining whether a file is an application or a dynamic-link library (DLL).
- ◆ Viewing the attributes set by the module-definition file.
- ◆ Viewing the number and size of code and data segments.
- ◆ Setting a new stack allocation.

Many of the header fields contain information that was set in the module-definition file or as input options when the LINK utility created the file. This chapter assumes you are familiar with LINK and module-definition files. For information about LINK, see Chapter 13. For information about module-definition (.DEF) files, see Chapter 14. Many of the terms and keywords used in this section are explained in these chapters.

## Running EXEHDR

This section describes the EXEHDR command line and the options available for controlling EXEHDR.

## The EXEHDR Command Line

To run EXEHDR, use the following command line:

EXEHDR *[[options]] filenames*

The *options* field specifies options used to modify EXEHDR output or change the file header. Options are described in the next section.

The *filenames* field specifies one or more applications or DLLs. If you do not provide an extension, EXEHDR assumes .EXE. You can specify a path with the filename.

## EXEHDR Options

Option names are not case sensitive and can be abbreviated to the shortest unique name. This section uses meaningful yet legal forms of the option names. Specify number arguments to options in decimal format or C-language notation. EXEHDR has the following options:

*/HEA[[P]]:number*

Sets the heap allocation field to *number* bytes. This option is only for segmented-executable files.

*/HEL[[P]]*

Calls the QuickHelp utility. If EXEHDR cannot locate the Help file or QuickHelp, it displays a brief summary of EXEHDR command-line syntax.

*/MA[[X]]:number*

Sets the maximum memory allocation to *number* 16-byte paragraphs. The memory allocation fields tell MS-DOS the maximum memory needed to load and run the program. The *number* must equal or exceed the minimum allocation. This option is equivalent to LINK's /CPARM option and applies only to MS-DOS programs.

*/MI[[N]]:number*

Sets the minimum memory allocation to *number* 16-byte paragraphs. See the /MAX option for more information.

*/NE[[WFILES]]*

Sets a bit in the header to notify the loader that the program may be using an installable file system.

*/NO[[LOGO]]*

Suppresses the EXEHDR copyright message.

*/P[[MTYPE]]:type*

Sets the type of application. The *type* is one of the keywords for either LINK's /PM option or the NAME statement in a .DEF file. The keywords are **PM** (or **WINDOWAPI**), **VIO** (or **WINDOWCOMPAT**), and **NOVIO** (or **NOTWINDOWCOMPAT**).

**/R[[ESETERROR]]**

Clears the error bit in the header of a segmented-executable file. LINK sets the error bit when it finds an unresolved reference or duplicate symbol definition. The operating system does not load a program if this bit is set. EXEHDR displays the message `Error in image` if it finds the error bit set. This option allows you to run a program that contains LINK errors and is useful during application development.

**/S[[TACK]]:*number***

Sets the stack allocation to *number* bytes. The `/STACK` option is equivalent to LINK's `/STACK` option.

**/V[[ERBOSE]]**

Provides more information about segmented-executable files. The additional information includes the default flags in the segment table, all run-time relocations, and additional fields from the header. For more information, see “EXEHDR Output: Verbose Output” on page 521.

**/?**

Displays a brief summary of EXEHDR command-line syntax.

## Executable-File Format

MS-DOS applications have a simple format, which consists of a single header followed by a relocation table and the load module. Segmented-executable files have two headers. The first header, usually called the MS-DOS header, has a simple format. The second header, sometimes called the new .EXE header, has a more detailed format. Figure 15.1 shows the arrangement of the headers in a segmented-executable file. When the executable file runs with MS-DOS, the operating system uses the old header to load the file. Otherwise, the system ignores the MS-DOS (or “old”) header and uses the new header.

The listing generated by EXEHDR shows the contents of the file header and information about each segment in the file. The type of listing generated reflects the structure of the header for the kind of file being checked. (For more information about the structure of MS-DOS applications and segmented-executable files, see the *MS-DOS Encyclopedia*.)

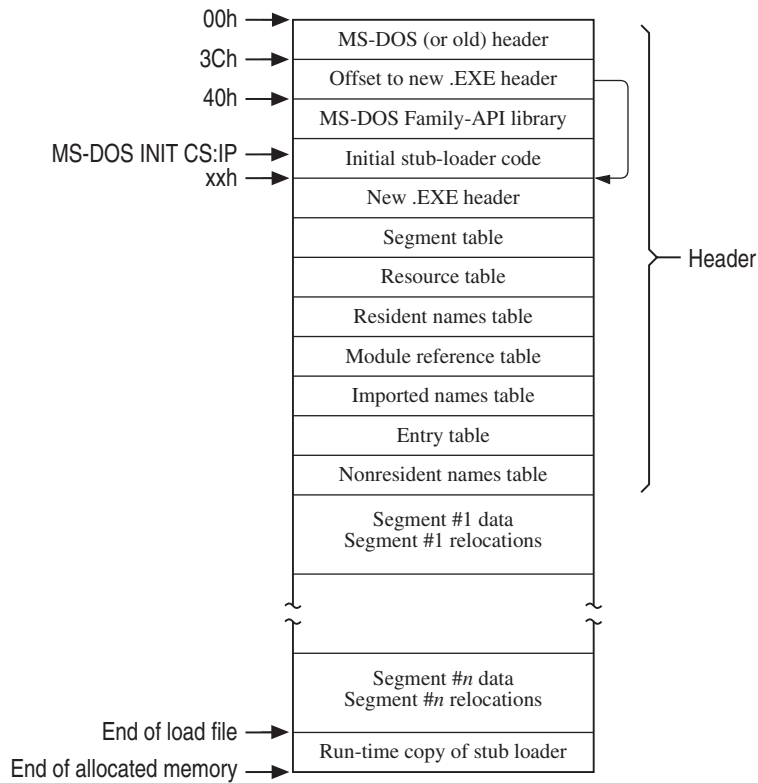

Figure 15.1 Format for a Segmented-Executable File

## EXEHDR Output: MS-DOS Executable File

The EXEHDR output for an MS-DOS executable file appears as follows:

.EXE size (bytes)  
Packed .EXE file  
Magic number:  
Bytes on last page:  
Pages in file:  
Relocations:  
Paragraphs in header:  
Extra paragraphs needed:  
Extra paragraphs wanted:  
Initial stack location:  
Word checksum:  
Entry point:  
Relocation table address:  
Memory needed:

The meaning of each field is described in the following list:

.EXE size (bytes)  
Gives the size of the file on disk.

Packed .EXE file  
Is displayed only if the file is packed.

Magic number:  
Tells the operating-system loader the format of the header.

Bytes on last page:  
Tells the loader how much data exists in the last page on disk.

Pages in file:  
Gives the number of whole 512-byte pages in the file on disk. If the program contains overlays, this field shows the number of pages in the root.

Relocations:  
Tells the loader the number of entries in the relocation table.

Paragraphs in header:  
Gives the size of the header in 16-byte paragraphs. This represents the offset of the load image within the file.

Extra paragraphs needed:  
Tells the loader the required minimum number of paragraphs of memory in addition to the image size. The image size is equal to Bytes on last page + (Pages in file x 512).

Extra paragraphs wanted:  
Tells the loader the number of paragraphs of memory above the size on disk requested for loading the program. This value is set by LINK's /CPARM option.

Initial stack location:  
Gives the address (SS:SP) of the MS-DOS program's stack.

Word checksum:

Confirms for the loader that the file is a valid executable file.

Entry point:

Gives the start address.

Relocation table address:

Gives the location of the table of relocation pointers as an offset from the beginning of the file.

Memory needed:

Tells the loader the total memory needed to load the application. The value in this field is equal to (Extra paragraphs needed x 16) + .EXE size (bytes).

## EXEHDR Output: Segmented-Executable File

The first part of the EXEHDR output for a segmented-executable file appears as follows:

```
Module:  
Description:  
Data:  
Initial CS:IP:  
Initial SS:SP:  
Extra stack allocation:  
DGROUP:
```

The meaning of each field is described in the following list:

Module:

Gives the name of the application as specified in the **NAME** statement of the .DEF file used to create the file or the name assumed by default.

Description:

Gives the text of the **DESCRIPTION** statement of the .DEF file or the description assumed by default.

Data:

Indicates the program's default data segment (DGROUP) type: **SHARED**, **NONSHARED**, or **NONE**. This type can be specified in a .DEF file.

Initial CS:IP:

Gives the application's starting address.

Initial SS:SP:

Gives the value of the initial stack pointer, which gives the location of the initial stack.

Extra stack allocation:

Gives the size in bytes of the stack, specified in hexadecimal.



**DGROUP:**

Gives the segment number of DGROUP in the program's object files. Segment numbers start with the number 1.

At the end of the list of fields, EXEHDR displays any module flags that were set for every segment in the module. For example, `PROTMODE` may appear.

The message `Error in image` may appear at the end of the list of fields. If a `LINK` error (such as "unresolved external") occurs when the file is created, `LINK` sets the error bit in the header. This prevents the file from being loaded. You can clear the error bit with the `/RESET` option, described on page 515.

## DLL Header Differences

For a DLL, the output differs slightly and appears as

```
Library:  
Description:  
Data:  
Initialization:  
Initial CS:IP:  
Initial SS:SP:  
DGROUP:
```

The meaning of each field is described in the following list:

**Library:**

Gives the name of the library as specified in the **LIBRARY** statement in the module-definition file (or the default name).

**Description:****Data:**

Same as for other segmented-executable files.

**Initialization:**

Gives the type of initialization as specified in the **LIBRARY** statement in the module-definition file (or the default initialization).

**Initial CS:IP:**

Gives the address of the initialization routine. If the DLL has no initialization routine, the start address is zero.

**Initial SS:SP:**

May be zero for a DLL.

**DGROUP:**

May not appear for a DLL.

## Segment Table

After the header fields for a segmented-executable file, EXEHDR displays the segment table. All values appear in hexadecimal except for the segment index number. An example of this table is:

```
no. type address file mem flags
  1 CODE 00000400 00efb 00efb
  2 DATA 00001400 00031 0007d
  3 DATA 00001600 0003c 00040 SHARED
```

The following list describes each heading in the segment table:

no.

Segment index number (in decimal), starting with 1.

type

Identification of the segment as a code or data segment.

address

A seek offset for the segment within the file.

file

Size in bytes of the segment in the file on disk.

mem

Size in bytes of the segment in memory. If mem is greater than file, the operating system pads the extra space with zero values at load time.

flags

Segment attributes. If the /V option is not used, only nondefault attributes are listed. Attributes that are meaningful only to the Windows operating system are displayed in lowercase and in parentheses.

## Exports Table

Following the segment table, EXEHDR displays a table of exports if they exist. An example of this table is:

```
Exports:
ord seg offset name
  1  3  0000  HELPWNDPROC exported
 19  3  032e  ICONWNDPROC exported
 21 35  0000  PATHWNDPROC exported
  5 30  0264  ANNOUPDATEDLG exported
  8 33  0000  BOOKMARKDLG exported
```

The following list describes each heading in the Exports table:

`ord`

The ordinal number as specified in the `@ord` field in an **EXPORTS** statement in a module-definition file. If `ord` was not specified, this column entry is blank.

`seg`

The index of the segment where the exported name is defined.

`offset`

The offset in the segment where the exported name is defined.

`name`

The exported name of the routine plus all flags applied to the exported routine, as specified in the **EXPORTS** statement in the module-definition file.

## EXEHDR Output: Verbose Output

The `/V` option provides more extensive information about a segmented-executable file. The verbose output more closely reflects the file's header structure. (For an illustration of this structure, see Figure 15.1 on page 516.)

## MS-DOS Header Information

EXEHDR begins by displaying the MS-DOS fields described on page 517, with the addition of two fields:

`Reserved words:`

Displays the contents of space in an MS-DOS header that is normally unused.

`New .EXE header address:`

Holds the starting location of the part of the header describing the segmented-executable file.

## New .EXE Header Information

EXEHDR then displays the header fields for the segmented-executable file. In addition to the default fields described on page 518, the verbose output includes many other fields.

A field called `Operating system:` follows the `Description:` field. This field tells the system under which the program is to run.

The following fields are then displayed:

Linker version:  
32-bit Checksum:  
Segment Table:  
Resource Table:  
Resident Names Table:  
Module Reference Table:  
Imported Names Table:  
Entry Table:  
Non-resident Names Table:  
Movable entry points:  
Segment sector size:  
Heap allocation:  
Application type:  
Other module flags:

The meaning of each field is described in the following list:

Linker version:

Tells which version of LINK was used to create the segmented-executable file.

32-bit Checksum:

Confirms for the loader that the file is a valid executable file. (See the `word checksum:` field for MS-DOS executable files.)

Segment Table:

Resource Table:

Resident Names Table:

Module Reference Table:

Imported Names Table:

Entry Table:

Non-resident Names Table:

Describe various tables in the segmented-executable file. Each description gives the table name, its address within the file, and its length in hexadecimal and in decimal.

Movable entry points:

Gives the number of entries to segments that have the **MOVABLE** attribute. This field is used only by the Windows operating system.

Segment sector size:

Gives the alignment set by the `/ALIGN` option or the default of 512. This field equals the sector size on disk.

Heap allocation:

Gives the size of the heap. This field is displayed only if a **HEAPSIZE** statement appeared in the module-definition file.

Application type:

Gives the type as specified in the **NAME** statement of the module-definition file used to create the file being examined, or as specified with LINK's /PM option, or assumed by default. For a DLL, a 0 is always displayed.

Other module flags:

Gives other attributes of the file; if none, this field is not displayed.

At the end of the list of fields, EXEHDR displays any module flags that were set for every segment in the module. For example, `PROTMODE` may appear.

## Tables

Following the header fields, EXEHDR displays the segment table with complete attributes, not just the nondefault attributes. Attributes that are meaningful only to the Windows operating system are displayed in lowercase and in parentheses. In addition to the attributes specified in the module-definition file (described in "CODE, DATA, and SEGMENTS Attributes" on page 503) or assumed by default, the verbose output includes the following two attributes:

- ◆ The `relocs` attribute is displayed for each segment that has address relocations. Relocations occur in each segment that references objects in other segments or makes dynamic-link references.
- ◆ The `iterated` attribute is displayed for each segment that has iterated data. Iterated data consist of a special code that packs repeated bytes.

EXEHDR then displays the Exports table if exports exist.

## Relocations

Following the tables, EXEHDR displays descriptions of relocations. Each has a heading in the following form:

```

1 type    offset target
  BASE    eff4  seg   1 offset 0000
  BASE    f204  seg   2 offset 0000
  OFFSET  eff1  seg   1 offset e968
  OFFSET  314e  seg   1 offset 32ea
  BASE    c0f1  seg   3 offset 0000
  OFFSET  d397  seg   1 offset cf70
  PTR     cd3e  imp  DOSCALLS.137
  OFFSET  b1a8  seg   1 offset ae7c
  PTR     f57c  imp  KBDCALLS.13

```

The following list describes each heading:

*number*

The segment number, as given earlier in the segments table.

*type*

Relocation type, which gives the kind of address information requested.

*offset*

The location of the requested address change in the source segment.

*target*

The requested relocation address.

Each relocation table ends by stating the total number of relocations.

P A R T 4

# Utilities

Chapter 16	Managing Projects with NMAKE .....	527
Chapter 17	Managing Libraries with LIB. ....	581
Chapter 18	Creating Help Files with HELPMAKE .....	593
Chapter 19	Browser Utilities .....	615
Chapter 20	Using Other Utilities .....	631





## Managing Projects with NMAKE

This chapter describes the Microsoft Program Maintenance Utility (NMAKE) version 1.20. NMAKE is a sophisticated command processor that saves time and simplifies project management. Once you specify which project files depend on others, NMAKE automatically builds your project without recompiling files that haven't changed since the last build.

If you are using the Programmer's Workbench (PWB) to build your project, PWB automatically creates a makefile and calls NMAKE to run the file. You may want to read this chapter if you intend to build your program outside of PWB, if you want to understand or modify a makefile created by PWB, or if you want to use a foreign makefile in PWB.

NMAKE can swap itself to expanded memory, extended memory, or disk to leave room for the commands it spawns. (For more information, see the description of the /M option on page 531.)

### New Features

NMAKE version 1.20 offers the following new features. For details of each feature, see the reference part of this chapter.

- ◆ New options: /B, /K, /M, /V
- ◆ The **!MESSAGE** directive
- ◆ Two preprocessing operators: **DEFINED**, **EXIST**
- ◆ Three keywords for use with the **!ELSE** directive: **IF**, **IFDEF**, **IFNDEF**
- ◆ New directives: **!ELSEIF**, **!ELSEIFDEF**, **!ELSEIFNDEF**
- ◆ Addition of .CPP and .CXX to the **.SUFFIXES** list
- ◆ Predefined macros for C++ programs: **CPP**, **CXX**, **CPPFLAGS**, **CXXFLAGS**
- ◆ Predefined inference rules for C++ programs

## Overview

NMAKE works by looking at the “time stamp” of a file. A time stamp is the time and date the file was last modified. Time stamps are assigned by most operating systems in 2-second intervals. NMAKE compares the time stamps of a “target” file and its “dependent” files. A target is usually a file you want to create, such as an executable file, though it could be a label for a set of commands you wish to execute. A dependent is usually a file from which a target is created, such as a source file. A target is “out-of-date” if any of its dependents has a later time stamp than the target or if the target does not exist. (For information on how the 2-second interval affects your build, see the description of the /B option on page 530.)

---

**Warning** For NMAKE to work properly, the date and time setting on your system must be consistent relative to previous settings. If you set the date and time each time you start the system, be careful to set it accurately. If your system stores a setting, be certain that the battery is working.

---

When you run NMAKE, it reads a “makefile” that you supply. A makefile (sometimes called a description file) is a text file containing a set of instructions that NMAKE uses to build your project. The instructions consist of description blocks, macros, directives, and inference rules. Each description block typically lists a target (or targets), the target’s dependents, and the commands that build the target. NMAKE compares the time stamp on the target file with the time stamp on the dependent files. If the time stamp of any dependent is the same as or later than the time stamp of the target, NMAKE updates the target by executing the commands listed in the description block.

It is possible to run NMAKE without a makefile. In this case, NMAKE uses predefined macros and inference rules along with instructions given on the command line or in TOOLS.INI. (For information on the TOOLS.INI file, see page 534.)

NMAKE’s main purpose is to help you build programs quickly and easily. However, it is not limited to compiling and linking; NMAKE can run other types of programs and can execute operating system commands. You can use NMAKE to prepare backups, move files, and perform other project-management tasks that you ordinarily do at the operating-system prompt.

This chapter uses the term “build,” as in building a target, to mean evaluating the time stamps of a target and its dependent and, if the target is out of date, executing the commands associated with the target. The term “build” has this meaning whether or not the commands actually create or change the target file.

## Running NMAKE

You invoke NMAKE with the following syntax:

```
NMAKE [[options]] [[macros]] [[targets]]
```

The *options* field lists NMAKE options, which are described in the following section, “Command-Line Options.”

The *macros* field lists macro definitions, which allow you to change text in the makefile. The syntax for macros is described in “User-Defined Macros” on page 551.

The *targets* field lists targets to build. NMAKE builds only the targets listed on the command line. If you don’t specify a target, NMAKE builds only the first target in the first dependency in the makefile. (You can use a pseudotarget to tell NMAKE to build more than one target. See “Pseudotargets” on page 540.)

NMAKE uses the following priorities to determine how to conduct the build:

1. If the /F option is used, NMAKE searches the current or specified directory for the specified makefile. NMAKE halts and displays an error message if the file does not exist.
2. If you do not use the /F option, NMAKE searches the current directory for a file named MAKEFILE.
3. If MAKEFILE does not exist, NMAKE checks the command line for target files and tries to build them using inference rules (either defined in TOOLS.INI or predefined). This feature lets you use NMAKE without a makefile as long as NMAKE has an inference rule for the target.
4. If a makefile is not used and the command line does not specify a target, NMAKE halts and displays an error message.

### Example

The following command specifies an option (/S) and a macro definition ("program=sample") and tells NMAKE to build two targets (sort.exe and search.exe). The command does not specify a makefile, so NMAKE looks for MAKEFILE or uses inference rules.

```
NMAKE /S "program=sample" sort.exe search.exe
```

For information on NMAKE macros, see page 550.

## Command-Line Options

NMAKE accepts options for controlling the NMAKE session. Options are not case sensitive and can be preceded by either a slash (/) or a dash (-).

You can specify some options in the makefile or in TOOLS.INI.

**/A**

Forces NMAKE to build all evaluated targets, even if the targets are not out-of-date with respect to their dependents. This option does not force NMAKE to build unrelated targets.

**/B**

Tells NMAKE to execute a dependency even if time stamps are equal. Most operating systems assign time stamps with a resolution of 2 seconds. If your commands execute quickly, NMAKE may conclude that a file is up to date when in fact it is not. This option may result in some unnecessary build steps but is recommended when running NMAKE on very fast systems.

**/C**

Suppresses default NMAKE output, including nonfatal NMAKE error or warning messages, time stamps, and the NMAKE copyright message. If both /C and /K are specified, /C suppresses the warnings issued by /K.

**/D**

Displays information during the NMAKE session. The information is interspersed in NMAKE's default output to the screen. NMAKE displays the time stamp of each target and dependent evaluated in the build and issues a message when a target does not exist. Dependents for a target precede the target and are indented. The /D and /P options are useful for debugging a makefile.

To set or clear /D for part of a makefile, use the **!CMDSWITCHES** directive; see "Preprocessing Directives" on page 572.

**/E**

Causes environment variables to override macro definitions in the makefile. See "Macros" on page 550.

**/F *filename***

Specifies *filename* as the name of the makefile. Zero or more spaces or tabs precede *filename*. If you supply a dash (-) instead of a filename, NMAKE gets makefile input from the standard input device. (End keyboard input with either F6 or CTRL+Z.) NMAKE accepts more than one makefile; use a separate /F specification for each makefile input.

If you omit /F, NMAKE searches the current directory for a file called MAKEFILE (with no extension) and uses it as the makefile. If MAKEFILE doesn't exist, NMAKE uses inference rules for the command-line targets.

**/HELP**

Calls the QuickHelp utility. If NMAKE cannot locate the Help file or QuickHelp, it displays a brief summary of NMAKE command-line syntax.

**/I**

Ignores exit codes from all commands listed in the makefile. NMAKE processes the whole makefile even if errors occur. To ignore exit codes for part of a makefile, use the dash (-) command modifier or the **.IGNORE** directive; see “Command Modifiers” on page 544 and “Dot Directives” on page 570. To set or clear /I for part of a makefile, use the **!CMDSWITCHES** directive; see “Preprocessing Directives” on page 572. To ignore errors for unrelated parts of the build, use the /K option; /I overrides /K if both are specified.

**/K**

Continues the build for unrelated parts of the dependency tree if a command terminates with an error. By default, NMAKE halts if any command returns a nonzero exit code. If this option is specified and a command returns a nonzero exit code, NMAKE ceases to execute the block containing the command. It does not attempt to build the targets that depend on the results of that command; instead, it issues a warning and builds other targets. When /K is specified and the build is not complete, NMAKE returns an exit code of 1. This differs from the /I option, which ignores exit codes entirely; /I overrides /K if both are specified. The /C option suppresses the warnings issued by /K.

**/M**

Swaps NMAKE to disk to conserve extended or expanded memory under MS-DOS. By default, NMAKE leaves room for commands to be executed in low memory by swapping itself to extended memory (if enough space exists there) or to expanded memory (if there is not sufficient extended memory but there is enough expanded memory) or to disk. The /M option tells NMAKE to ignore any extended or expanded memory and to swap only to disk.

**/N**

Displays but does not execute the commands that would be executed by the build. Preprocessing commands are executed. This option is useful for debugging makefiles and checking which targets are out-of-date. To set or clear /N for part of a makefile, use the **!CMDSWITCHES** directive; see “Preprocessing Directives” on page 572.

**/NOLOGO**

Suppresses the NMAKE copyright message.

**/P**

Displays NMAKE information to the standard output device, including all macro definitions, inference rules, target descriptions, and the **.SUFFIXES** list, before running the NMAKE session. If /P is specified without a makefile or command-line target, NMAKE displays the information and does not issue an error. The /P and /D options are useful for debugging a makefile.

**/Q**

Checks time stamps of targets that would be updated by the build but does not run the build. NMAKE returns a zero exit code if the targets are up-to-date and a nonzero exit code if any target is out-of-date. Only preprocessing commands in the makefile are executed. This option is useful when running NMAKE from a batch file.

**/R**

Clears the **.SUFFIXES** list and ignores inference rules and macros that are defined in the TOOLS.INI file or that are predefined.

**/S**

Suppresses the display of all executed commands. To suppress the display of commands in part of a makefile, use the @ command modifier or the **.SILENT** directive; see “Command Modifiers” on page 544 and “Dot Directives” on page 570. To set or clear /S for part of a makefile, use the **!CMDSWITCHES** directive; see “Preprocessing Directives” on page 572.

**/T**

Changes time stamps of command-line targets (or first target in the makefile if no command-line targets are specified) to the current time and executes preprocessing commands but does not run the build. Contents of target files are not modified.

**/V**

Causes all macros to be inherited when recursing. By default, only macros defined on the command line and environment-variable macros are inherited when NMAKE is called recursively. This option makes all macros available to the recursively called NMAKE session. See “Inherited Macros” on page 563.

**/X filename**

Sends all NMAKE error output to *filename*, which can be a file or a device. Zero or more spaces or tabs can precede *filename*. If you supply a dash (–) instead of a filename, NMAKE sends its error output to standard output. By default, NMAKE sends errors to standard error. This option does not affect output that is sent to standard error by commands in the makefile.

**/?**

Displays a brief summary of NMAKE command-line syntax and exits to the operating system.

## Example

The following command line specifies two NMAKE options:

```
NMAKE /F sample.mak /C targ1 targ2
```

The /F option tells NMAKE to read the makefile SAMPLE.MAK. The /C option tells NMAKE not to display nonfatal error messages and warnings. The command specifies two targets (*targ1* and *targ2*) to update.

## NMAKE Command File

You can place a sequence of command-line arguments in a text file and pass the file's name as a command-line argument to NMAKE. NMAKE opens the command file and reads the arguments. You can use a command file to overcome the limit on the length of a command line in the operating system (128 characters in MS-DOS).

To provide input to NMAKE with a command file, type

```
NMAKE @commandfile
```

The *commandfile* is the name of a text file containing the information NMAKE expects on the command line. Precede the name of the command file with an at sign (@). You can specify a path with the filename.

NMAKE treats the file as if it were a single set of arguments. It replaces each line break with a space. Macro definitions that contain spaces must be enclosed in quotation marks; see "Where to Define Macros" on page 552.

You can split input between the command line and a command file. Specify @*commandfile* on the command line at the place where the file's information is expected. Command-line input can precede and/or follow the command file. You can specify more than one command file.

### Example 1

If a file named UPDATE contains the line

```
/S "program = sample" sort.exe search.exe
```

you can start NMAKE with the command

```
NMAKE @update
```

The effect is the same as if you entered the following command line:

```
NMAKE /S "program = sample" sort.exe search.exe
```

### Example 2

The following is another version of the UPDATE file:

```
/S "program \  
= sample" sort.exe search.exe
```

The backslash (\) allows the macro definition to span two lines.

### Example 3

If the command file called UPDATE contains the line

```
/S "program = sample" sort.exe
```

you can start NMAKE with the command

```
NMAKE @update search.exe
```

## The TOOLS.INI File

You can customize NMAKE by placing commonly used information in the TOOLS.INI initialization file. Settings for NMAKE must follow a line that begins with the tag [NMAKE]. The tag is not case sensitive. This section of the initialization file can contain any makefile information. NMAKE uses this information in every session, unless you run NMAKE with the /R option. NMAKE looks for TOOLS.INI first in the current directory and then in the directory specified by the INIT environment variable.

You can use the **!CMDSWITCHES** directive to specify command-line options in TOOLS.INI. An option specified this way is in effect for every NMAKE session. This serves the same purpose as does an environment variable, which is a feature available in other utilities. For more information on **!CMDSWITCHES**, see page 572.

Macros and inference rules appearing in TOOLS.INI can be overridden. See “Precedence Among Macro Definitions” on page 563 and “Precedence Among Inference Rules” on page 570.

NMAKE reads information in TOOLS.INI before it reads makefile information. Thus, for example, a description block appearing in TOOLS.INI acts as the first description block in the makefile; this is true for every NMAKE session, unless /R is specified.

To place a comment in TOOLS.INI, specify the comment on a separate line beginning with a semicolon (;). You can also specify comments with a number sign (#) as you can in a makefile; for more information, see “Comments” on page 536.

### Example

The following is an example of text in a TOOLS.INI file:



```
[NMAKE]
; macros
AS      = masm
AFLAGS = /FR /LA /ML /MX /W2
; inference rule
.asm.obj:
    $(AS) /ZD ZI $(AFLAGS) $.asm
```

NMAKE reads and applies the lines following `[NMAKE]`. The example redefines the macro `AS` to invoke the Microsoft Macro Assembler MASM.EXE utility, redefines the macro `AFLAGS`, and redefines the inference rule for making `.OBJ` files from `.ASM` sources. These NMAKE features are explained throughout this chapter.

## Contents of a Makefile

An NMAKE makefile contains description blocks, macros, inference rules, and directives. This section presents general information about writing makefiles. The rest of the chapter describes each of the elements of makefiles in detail.

## Using Special Characters as Literals

You may need to specify as a literal character one of the characters that NMAKE uses for a special purpose. These characters are:

: ; # ( ) \$ ^ \ { } ! @ -

To use one of these characters without its special meaning, place a caret (^) in front of it. NMAKE ignores carets that precede characters other than the special characters listed previously. A caret within a quoted string is treated as a literal caret character.

You can also use a caret at the end of a line to insert a literal newline character in a string or macro. The caret tells NMAKE to interpret the newline character as part of the macro, not a line break. Note that this effect differs from using a backslash (\) to continue a line in a macro definition. A newline character that follows a backslash is replaced with a space. For more information, see “User-Defined Macros” on page 551.

In a command, a percent symbol (%) can represent the beginning of a file specifier. (See “Filename-Parts Syntax” on page 546.) NMAKE interprets %s as a filename, and it interprets the character sequence of %l followed by d, e, f, p, or F as part or all of a filename or path. If you need to represent these characters literally in a command, specify a double percent sign (%%) in place of a single one. In all other situations, NMAKE interprets a single % literally. However, NMAKE always interprets a double %% as a single %. Therefore, to represent a literal %, you can specify either three percent signs, %%%, or four percent signs, %%%%.

To use the dollar sign (\$) as a literal character in a command, you must specify two dollar signs (\$\$); this method can also be used in other situations where ^\$ also works.

For information on literal characters in macro definitions, see “Special Characters in Macros” on page 551.

## Wildcards

You can use MS-DOS wildcards (\* and ?) to specify target and dependent names. NMAKE expands wildcards that appear on dependency lines. A wildcard specified in a command is passed to the command; NMAKE does not expand it.

### Example

In the following description block, the wildcard \* is used twice:

```
project.exe : *.asm
ml *.asm /Feproject.exe
```

NMAKE expands the \*.asm in the dependency line and looks at all files having the .ASM extension in the current directory. If any .ASM file is out-of-date, the ML command expands the \*.c and compiles and links all files.

## Comments

To place a comment in a makefile, precede it with a number sign (#). If the entire line is a comment, the # must appear at the beginning of the line. Otherwise, the # follows the item being commented. NMAKE ignores all text from the number sign to the next newline character.

Command lines cannot contain comments; this is true even for a command that is specified on the same line as a dependency line or inference rule. This is because NMAKE does not parse a command; instead, it passes the entire command to the operating system. However, a comment can appear between lines in a commands block. To change a command to a comment, insert a # at the beginning of the command line.

You can use comments in the following situations:

```

# Comment on line by itself

OPTIONS = /MAP # Comment on macro definition line

all.exe : one.obj two.obj # Comment on dependency line
    link one.obj two.obj;
# Comment in commands block
    copy one.exe \release
# Command turned into comment:
#    copy *.obj \objects

.obj.exe: # Comment in inference rule

```

To specify a literal #, precede it with a caret (^), as in the following:

```
DEF = ^#define #Macro representing a C preprocessing directive
```

Comments can also appear in a TOOLS.INI file. TOOLS.INI allows an additional form of comment using a semicolon (;). See “The TOOLS.INI File” on page 534.

## Long Filenames

You can use long filenames if they are supported by your file system. However, you must enclose the name in double quotation marks, as in the following dependency line:

```
all : "VeryLongFileName.exe"
```

## Description Blocks

Description blocks form the heart of the makefile. The following is a typical NMAKE description block:

```

      Targets                Dependents
      |                      |
  myapp.exe : myapp.obj another.obj myapp.def } Dependency line
      link myapp another, , NUL, mylib, myapp } Commands
      copy myaoo.exe c:\project

```

**Figure 16.1** NMAKE Description Block

The first line in a description block is the “dependency line.” In this example, the dependency contains one “target” and three “dependents.” The dependency is followed by a commands block that lists one or more commands. The following sections discuss dependencies, targets, and dependents. The contents of a commands block are described in “Commands” on page 543.

## Dependency Line

A description block begins with a “dependency line.” A dependency line specifies one or more “target” files and then lists zero or more “dependent” files. If a target does not exist, or if its time stamp is earlier than that of any dependent, NMAKE executes the commands block for that target. The following is an example of a dependency line:

```
myapp.exe : myapp.obj another.obj myapp.def
```

This dependency line tells NMAKE to rebuild the MYAPP.EXE target whenever MYAPP.OBJ, ANOTHER.OBJ, or MYAPP.DEF has changed more recently than MYAPP.EXE.

The dependency line must not be indented (it cannot start with a space or tab). The first target must be specified at the beginning of the line. Targets are separated from dependents by a single colon, except as described in “Using Targets in Multiple Description Blocks” on page 539. The colon can be preceded or followed by zero or more spaces or tabs. The entire dependency must appear on one line; however, you can extend the line by placing a backslash (\) after a target or dependent and continuing the dependency on the next line.

Before executing any commands, NMAKE moves through all dependencies and applicable inference rules to build a “dependency tree” that specifies all the steps required to fully update the target. NMAKE checks to see if dependents themselves are targets in other dependency lists, if any dependents in those lists are targets elsewhere, and so on. After it builds the dependency tree, NMAKE checks time stamps. If it finds any dependents in the tree that are newer than the target, NMAKE builds the target.

## Targets

The targets section of the dependency line lists one or more target names. At least one target must be specified. Separate multiple target names with one or more spaces or tabs. You can specify a path with the filename. Targets are not case sensitive. A target (including path) cannot exceed 256 characters.

If the name of the last target before the colon (:) is a single character, you must put a space between the name and the colon; otherwise, NMAKE interprets the letter-colon combination as a drive specifier.

Usually a target is the name of a file to be built using the commands in the description block. However, a target can be any valid filename, or it can be a pseudotarget. (For more information, see “Pseudotargets” on page 540.)

NMAKE builds targets specified on the NMAKE command line. If a command-line target is not specified, NMAKE builds the first target in the first dependency in the makefile.

The example in the previous section tells NMAKE how to build a single target file called MYAPP.EXE if it is missing or out-of-date.

## Using Targets in Multiple Description Blocks

A target can appear in only one description block when specified using the single-colon (:) syntax to separate the target from the dependent. To update a target using more than one description block, specify two consecutive colons (::) between targets and dependents. One use for this feature is for building a complex target that contains components created with different commands.

### Example

The following makefile updates a library:

```
target.lib :: one.asm two.asm three.asm
    ML one.asm two.asm three.asm
    LIB target ++one.obj ++two.obj ++three.obj;
target.lib :: four.c five.c
    CL /c four.c five.c
    LIB target ++four.obj ++five.obj;
```

If any of the assembly-language files have changed more recently than the library, NMAKE assembles the source files and updates the library. Similarly, if any of the C-language files have changed, NMAKE compiles the C files and updates the library.

## Accumulating Targets in Dependencies

Dependency lines are cumulative when the same target appears more than once in a single description block. For example,

```
bounce.exe : jump.obj
bounce.exe : up.obj
    echo Building bounce.exe...
```

is evaluated by NMAKE as

```
bounce.exe : jump.obj up.obj
    echo Building bounce.exe...
```

This evaluation has several effects. Since NMAKE builds the dependency tree based on one target at a time, the lines can contain other targets, as in:

```
bounce.exe leap.exe : jump.obj
bounce.exe climb.exe : up.obj
    echo Building bounce.exe...
```

The preceding example is evaluated by NMAKE as

```
bounce.exe : jump.obj
leap.exe : jump.obj
bounce.exe : up.obj
climb.exe : up.obj...
    echo Building bounce.exe...
```

NMAKE evaluates a dependency for each of the three targets as if each were specified in a separate description block. If `bounce.exe` or `climb.exe` is out-of-date, NMAKE runs the given command. If `leap.exe` is out-of-date, the given command does not apply, and NMAKE tries to use an inference rule.

If the same target is specified in two single-colon dependency lines in different locations in the makefile, and if commands appear after only one of the lines, NMAKE interprets the dependency lines as if they were adjacent or combined. This can cause an unwanted side effect: NMAKE does not invoke an inference rule for the dependency that has no commands (see “Inference Rules” on page 563). Rather, it assumes that the dependencies belong to one description block and executes the commands specified with the other dependency.

The following makefile is interpreted in the same way as the preceding examples:

```
bounce.exe : jump.obj
    echo Building bounce.exe...
.
.
.
bounce.exe : up.obj
```

This effect does not occur if the colons are doubled (`::`) after the duplicate targets. A double-colon dependency with no commands block invokes an inference rule, even if another double-colon dependency containing the same target is followed by a commands block.

## Pseudotargets

A “pseudotarget” is a target that doesn’t specify a file but instead names a label for use in executing a group of commands. NMAKE interprets the pseudotarget as a file that does not exist and thus is always out-of-date. When NMAKE evaluates a pseudotarget, it always executes its commands block. Be sure that the current directory does not contain a file with a name that matches the pseudotarget.

A pseudotarget name must follow the syntax rules for filenames. Like a filename target, a pseudotarget name is not case sensitive. However, if the name does not have an extension (that is, it does not contain a period), it can exceed the 8-character limit for filenames and can be up to 256 characters long.

A pseudotarget can be listed as a dependent. A pseudotarget used this way must appear as a target in another dependency; however, that dependency does not need to have a commands block.

A pseudotarget used as a target has an assumed time stamp that is the most recent time stamp of all its dependents. If a pseudotarget has no dependents, the assumed time stamp is the current time. NMAKE uses the assumed time stamp if the pseudotarget appears as a dependent elsewhere in the makefile.

Pseudotargets are useful when you want NMAKE to build more than one target automatically. NMAKE builds only those targets specified on the NMAKE command line, or, when no command-line target is specified, it builds only the first target in the first dependency in the makefile. To tell NMAKE to build multiple targets without having to list them on the command line, write a description block with a dependency containing a pseudotarget and list as its dependents the targets you want to build. Either place this description block first in the makefile or specify the pseudotarget on the NMAKE command line.

### Example 1

In the following example, UPDATE is a pseudotarget.

```
UPDATE : *.*
        !COPY *** a:\product
```

If UPDATE is evaluated, NMAKE copies all files in the current directory to the specified drive and directory.

### Example 2

In the following makefile, the pseudotarget all builds both PROJECT1.EXE and PROJECT2.EXE if either all or no target is specified on the command line. The pseudotarget setenv changes the LIB environment variable before the .EXE files are updated:

```
all : setenv project1.exe project2.exe

project1.exe : project1.obj
        LINK project1;

project2.exe : project2.obj
        LINK project2;

setenv :
        set LIB=\project\lib
```

## Dependents

The dependents section of the dependency line lists zero or more dependent names. Usually a dependent is a file used to build the target. However, a dependent can be any valid filename, or it can be a pseudotarget. You can specify a path with the filename. Dependents are not case sensitive. Separate each dependent name with one or more spaces or tabs. A single or double colon (: or ::) separates it from the targets section.

Along with dependents you explicitly list in the dependency line, NMAKE can assume an “inferred dependent.” An inferred dependent is derived from an inference rule. (For more information, see “Inference Rules” on page 563.) NMAKE considers an inferred dependent to appear earlier in a dependents list than explicit dependents. It builds inferred dependents into the dependency tree. It is important to note that when an inferred dependent in a dependency is out-of-date with respect to a target, NMAKE invokes the commands block associated with the dependency, just as it does with an explicit dependent.

NMAKE uses the dependency tree to make sure that dependents themselves are updated before it updates their targets. If a dependent file doesn't exist, NMAKE looks for a way to build it; if it already exists, NMAKE looks for a way to make sure it is up-to-date. If the dependent is listed as a target in another dependency, or if it is implied as a target in an inference rule, NMAKE checks that the dependent is up-to-date with respect to its own dependents; if the dependent file is out-of-date or doesn't exist, NMAKE executes the commands block for that dependency.

The following example lists three dependents after MYAPP.EXE:

```
myapp.exe : myapp.obj another.obj myapp.def
```

## Specifying Search Paths for Dependents

You can specify the directories in which NMAKE should search for a dependent. The syntax for a directory specification is:

```
{directory[;directory...]}dependent
```

Enclose one or more directory names in braces ({}). Separate multiple directories with a semicolon (;). No spaces are allowed. You can use a macro to specify part or all of a search path. NMAKE searches the current directory first, then the directories in the order specified. A search path applies only to a single dependent.

### Example

The following dependency line contains a directory specification:

```
forward.exe : {\src\alpha;d:\proj}pass.obj
```



The target FORWARD.EXE has one dependent, PASS.OBJ. The directory list specifies two directories. NMAKE first searches for PASS.OBJ in the current directory. If PASS.OBJ isn't there, NMAKE searches the \SRC\ALPHA directory, then the D:\PROJ directory.

## Commands

The commands section of a description block or inference rule lists the commands that NMAKE must run if the dependency is out-of-date. You can specify any command or program that can be executed from an MS-DOS command line (with a few exceptions, such as PATH). Multiple commands can appear in a commands block. Each appears on its own line (except as noted in the next section). If a description block doesn't contain any commands, NMAKE looks for an inference rule that matches the dependency. (See "Inference Rules" on page 563.) The following example shows two commands following a dependency line:

```
myapp.exe : myapp.obj another.obj myapp.def
    link myapp another, , NUL, mylib, myapp
    copy myapp.exe c:\project
```

NMAKE displays each command line before it executes it, unless you specify the /S option, the **.SILENT** directive, the **!CMDSWITCHES** directive, or the @ modifier.

## Command Syntax

A command line must begin with one or more spaces or tabs. NMAKE uses this indentation to distinguish between a dependency line and a command line.

Blank lines cannot appear between the dependency line and the commands block. However, a line containing only spaces or tabs can appear; this line is interpreted as a null command, and no error occurs. Blank lines can appear between command lines.

A long command can span several lines if each line ends with a backslash (\). A backslash at the end of a line is interpreted as a space on the command line. For example, the LINK command shown in previous examples in this chapter can be expressed as:

```
    link myapp\
another, , NUL, mylib, myapp
```

NMAKE passes the continued lines to the operating system as one long command. A command continued with a backslash must still be within the operating system's limit on the length of a command line. If any other character, such as a space or tab, follows the backslash, NMAKE interprets the backslash and the trailing characters literally.

You can also place a single command at the end of a dependency line, whether or not other commands follow in the indented commands block. Use a semicolon (;) to separate the command from the rightmost dependent, as in:

```
project.obj : project.c project.h ; cl /c project.c
```

## Command Modifiers

Command modifiers provide extra control over the commands in a description block. You can use more than one modifier for a single command. Specify a command modifier preceding the command being modified, optionally separated by spaces or tabs. Like a command, a modifier cannot appear at the beginning of a line. It must be preceded by one or more spaces or tabs.

The following describes the three NMAKE command modifiers.

### *@command*

Prevents NMAKE from displaying the command. Any results displayed by commands are not suppressed. Spaces and tabs can appear before the command. By default, NMAKE echoes all makefile commands that it executes. The /S option suppresses display for the entire makefile; the **.SILENT** directive suppresses display for part of the makefile.

### *-[number]command*

Turns off error checking for the command. Spaces and tabs can appear before the command. By default, NMAKE halts when any command returns an error in the form of a nonzero exit code. This modifier tells NMAKE to ignore errors from the specified command. If the dash is followed by a number, NMAKE stops if the exit code returned by the command is greater than that number. No spaces or tabs can appear between the dash and the number; they must appear between the number and the command. (For more information on using this number, see “Exit Codes from Commands” on page 545.) The /I option turns off error checking for the entire makefile; the **.IGNORE** directive turns off error checking for part of the makefile.

### *!command*

Executes the command for each dependent file if the command preceded by the exclamation point uses the predefined macros **\$\$\$** or **\$\$?**. (See “Filename Macros” on page 555.) Spaces and tabs can appear before the command. The **\$\$\$** macro represents all dependent files in the dependency line. The **\$\$?** macro refers to all dependent files in the dependency line that have a later time stamp than the target.

### Example 1

In the following example, the at sign (@) suppresses display of the ECHO command line:

```
sort.exe : sort.obj
    @ECHO Now sorting...
```

The output of the ECHO command is not suppressed.

### Example 2

In the following description block, if the program `sample` returns a nonzero exit code, NMAKE does not halt; if `sort` returns an exit code that is greater than 5, NMAKE stops:

```
light.lst : light.txt
    -sample light.txt
    -5 sort light.txt
```

### Example 3

The description block

```
print : one.txt two.txt three.txt
    !print $$ lpt1:
```

generates the following commands:

```
print one.txt lpt1:
print two.txt lpt1:
print three.txt lpt1:
```

## Exit Codes from Commands

NMAKE stops execution if a command or program executed in the makefile encounters an error and returns a nonzero exit code. The exit code is displayed in an NMAKE error message.

You can control how NMAKE behaves when a nonzero exit code occurs by using the `/I` or `/K` option, the `.IGNORE` directive, the `!CMDSWITCHES` directive, or the dash (`-`) command modifier.

Another way to use exit codes is during preprocessing. You can run a command or program and test its exit code using the `!IF` preprocessing directive. For more information, see “Executing a Program in Preprocessing” on page 575.

## Filename-Parts Syntax

NMAKE provides a syntax that you can use in commands to represent components of the name of the first dependent file. This file is generally the first file listed to the right of the colon in a dependency line. However, if a dependent is implied from an inference rule, NMAKE considers the inferred dependent to be the first dependent file, ahead of any explicit dependents. If more than one inference rule applies, the **.SUFFIXES** list determines which dependent is first. The filename components are the file's drive, path, base name, and extension as you have specified it, not as it exists on disk.

You can represent the complete filename with the following syntax:

`%s`

For example, if a description block contains

```
sample.exe : c:\project\sample.obj
    LINK %s;
```

NMAKE interprets the command as

```
LINK c:\project\sample.obj;
```

You can represent parts of the complete filename with the following syntax:

`%|[[parts]]F`

where *parts* can be zero or more of the following letters, in any order:

Letter	Description
No letter	Complete name
<b>d</b>	Drive
<b>p</b>	Path
<b>f</b>	File base name
<b>e</b>	File extension

Using this syntax, you can represent the full filename specification by `%|F` or by `%|dpfeF`, as well as by `%s`.

### Example

The following description block uses filename-parts syntax:

```
sample.exe : c:\project\sample.obj
    LINK %s, a:%|pfF.exe;
```

NMAKE interprets the first representation as the complete filename of the dependent. It interprets the second representation as a filename with the same path and base name as the dependent but on the specified drive and with the specified extension. It executes the following command:

```
LINK c:\project\sample.obj, a:\project\sample.exe;
```

---

**Note** For another way to represent components of a filename, see “Modifying Filename Macros” on page 556.

---

## Inline Files

NMAKE can create “inline files” in the commands section of a description block or inference rule. An inline file is created on disk by NMAKE and contains text you specify in the makefile. The name of the inline file can be used in commands in the same way as any filename. NMAKE creates the inline file only when it executes the command in which the file is created.

One way to use an inline file is as a response file for another utility such as LINK or LIB. Response files avoid the operating system limit on the maximum length of a command line and automate the specification of input to a utility. Inline files eliminate the need to maintain a separate response file. They can also be used to pass a list of commands to the operating system.

### Specifying an Inline File

The syntax for specifying an inline file in a command is:

```
<<[[filename]]
```

Specify the double angle brackets (<<) on the command line at the location where you want a filename to appear. Because command lines must be indented, the angle brackets cannot appear at the beginning of a line. The angle bracket syntax must be specified literally; it cannot be represented by a macro expansion.

When NMAKE executes the description block, it replaces the inline file specification with the name of the inline file being created. The effect is the same as if a filename was literally specified in the commands section.

The *filename* supplies a name for the inline file. It must immediately follow the angle brackets; no space is permitted. You can specify a path with the filename. No extension is required or assumed. If a file by the same name already exists, NMAKE overwrites it; such a file is deleted if the inline file is temporary. (Temporary inline files are discussed in the next section.)

A name is optional; if you don't specify *filename*, NMAKE gives the inline file a unique name. If *filename* is specified, NMAKE places the file in the directory specified with the name or in the current directory if no path is specified. If *filename* is not specified, NMAKE places the inline file in the directory specified by the TMP environment variable or in the current directory if TMP is not defined. You can reuse a previous inline *filename*; NMAKE overwrites the previous file.

## Creating an Inline File

The instructions for creating the inline file begin on the first line after the `<<[[filename]]` specification. The syntax to create the inline file is:

```
<<[[filename]]
inlinetext
.
.
.
<<[[KEEP | NOKEEP]]
```

The set of angle brackets marking the end of the inline file must appear at the beginning of a separate line in the makefile. All *inlinetext* before the delimiting angle brackets is placed in the inline file. The text can contain macro expansions and substitutions. Directives and comments are not permitted in an inline file; NMAKE treats them as literal text. Spaces, tabs, and newline characters are treated literally.

The inline file can be temporary or permanent. To retain the file after the end of the NMAKE session, specify **KEEP** immediately after the closing set of angle brackets. If you don't specify a preference, or if you specify **NOKEEP** (the default), the file is temporary. **KEEP** and **NOKEEP** are not case sensitive. The temporary file exists for the duration of the NMAKE session.

It is possible to specify **KEEP** for a file that you do not name; in this case, the NMAKE-generated filename appears in the appropriate directory after the NMAKE session.

## Example

The following makefile uses a temporary inline file to clear the screen and then display the contents of the current directory:

```
COMMANDS = cls ^
dir
showdir :
    <<showdir.bat
$(COMMANDS)
<<
```

In this example, the name of the inline file serves as the only command in the description block. This command has the same effect as running a batch file named SHOWDIR.BAT that contains the same commands as those listed in the macro definition.

## Reusing an Inline File

After an inline file is created, you can use it more than once. To reuse an inline file in the command in which it is created, you must supply a *filename* for the file where it is defined and first used. You can then reuse the name later in the same command.

You can also reuse an inline file in subsequent commands in the same description block or elsewhere in the makefile. Be sure that the command that creates the inline file executes before all commands that use the file. Regardless of whether you specify **KEEP** or **NOKEEP**, NMAKE keeps the file for the duration of the NMAKE session.

### Example

The following makefile creates a temporary LIB response file named LIB.LRF:

```
OBJECTS = add.obj sub.obj mul.obj div.obj
math.lib : $(OBJECTS)
    LIB math.lib @<<lib.lrf
-+$(?: = &^
-+)
listing;
<<
    copy lib.lrf \projinfo\lib.lrf
```

The resulting response file tells LIB which library to use, the commands to execute, and the name of the listing file to produce:

```
-+add.obj &
-+sub.obj &
-+mul.obj &
-+div.obj
listing;
```

The second command in the description block tells NMAKE to copy the response file to another directory.

## Using Multiple Inline Files

You can specify more than one inline file in a single command line. For each inline specification, specify one or more lines of inline text followed by a closing line containing the delimiter. Begin the second file's text on the line following the delimiting line for the first file.

### Example

The following example creates two inline files:

```
target.abc : depend.xyz
    copy <<file1 + <<file2 both.txt
I am the contents of file1.
<<
I am the contents of file2.
<<KEEP
```

This is equivalent to specifying

```
copy file1 + file2 both.txt
```

to concatenate two files, where FILE1 contains

```
I am the contents of file1.
```

and FILE2 contains

```
I am the contents of file2.
```

The **KEEP** keyword tells NMAKE not to delete FILE2. After the NMAKE session, the files FILE2 and BOTH.TXT exist in the current directory.

## Macros

Macros offer a convenient way to replace a particular string in the makefile with another string. You can define your own macros or use predefined macros. Macros are useful for a variety of tasks, such as:

- ◆ Creating a single makefile that works for several projects. You can define a macro that replaces a dummy filename in the makefile with the specific filename for a particular project.
- ◆ Controlling the options NMAKE passes to the compiler or linker. When you specify options in a macro, you can change options throughout the makefile in a single step.
- ◆ Specifying paths in an inference rule. (For an example, see Example 3 in “User-Defined Inference Rules” on page 567.)

This section describes user-defined macros, shows how to use a macro, and discusses the macros that have special meaning for NMAKE. It ends by discussing macro substitutions, inherited macros, and precedence rules.



## User-Defined Macros

To define a macro, use the following syntax:

```
macroname=string
```

The *macroname* can be any combination of letters, digits, and the underscore ( `_` ) character, up to 1024 characters. Macro names are case sensitive; NMAKE interprets `MyMacro` and `MYMACRO` as different macro names. The *macroname* can contain a macro invocation. If *macroname* consists entirely of an invoked macro, the macro being invoked cannot be null or undefined.

The *string* can be any sequence of zero or more characters up to 64K–25 (65,510 bytes). A string of zero characters is called a “null string.” A string consisting only of spaces, tabs, or both is also considered a null string.

Other syntax rules, such as the use of spaces, apply depending on where you specify the macro; see “Where to Define Macros” on page 552. The *string* can contain a macro invocation.

### Example

The following specification defines a macro named `DIR` and assigns to it a string that represents a directory.

```
DIR=c:\objects
```

## Special Characters in Macros

Certain characters have special meaning within a macro definition. You use these characters to perform specific tasks. If you want one of these characters to have a literal meaning, you must specify it using a special syntax.

- ◆ To specify a comment with a macro definition, place a number sign (`#`) and the comment after the definition, as in:

```
LINKCMD = link /CO # Prepare for debugging
```

NMAKE ignores the number sign and all characters up to the next newline character. To specify a literal number sign in a macro, use a caret ( `^` ), as in `^#`.

- ◆ To extend a macro definition to a new line, end the line with a backslash ( `\` ). The newline character that follows the backslash is replaced with a space when the macro is expanded, as in the following example:

```
LINKCMD = link myapp\  
another, , NUL, mylib, myapp
```

When this macro is expanded, a space separates `myapp` and `another`.

To specify a literal backslash at the end of the line, precede it with a caret (^), as in:

```
exepath = c:\bin^\
```

You can also make a backslash literal by following it with a comment specifier (#). NMAKE interprets a backslash as literal if it is followed by any other character.

- ◆ To insert a literal newline character into a macro, end the line with a caret (^). The caret tells NMAKE to interpret the newline character as part of the macro, not as a line break ending the macro definition. The following example defines a macro composed of two operating-system commands separated by a newline character:

```
CMDS = cls^  
dir
```

For an illustration of how this macro can be used, see the first example under “Inline Files” on page 548.

- ◆ To specify a literal dollar sign (\$) in a macro definition, use two dollar signs (\$\$). NMAKE interprets a single dollar sign as the specifier for invoking a macro; see “Using Macros” on page 554.

For information on how to handle other special characters literally, regardless of whether they appear in a macro, see “Using Special Characters as Literals” on page 535.

## Where to Define Macros

You can define macros in the makefile, on the command line, in a command file, or in TOOLS.INI. (For more information, see “Precedence Among Macro Definitions” on page 563.) Each macro defined in the makefile or in TOOLS.INI must appear on a separate line. The line cannot start with a space or tab.

When you define a macro in the makefile or in TOOLS.INI, NMAKE ignores any spaces or tabs on either side of the equal sign. The *string* itself can contain embedded spaces. You do not need to enclose *string* in quotation marks (if you do, they become part of the string). The macro name being defined must appear at the beginning of the line. Only one macro can be defined per line. For example, the following macro definition can appear in a makefile or TOOLS.INI:

```
LINKCMD = LINK /MAP
```

Slightly different rules apply when you define a macro on the NMAKE command line or in a command file. The command-line parser treats spaces and tabs as argument delimiters. Therefore, spaces must not precede or follow the equal sign. If *string* contains embedded spaces or tabs, either the string itself or the entire macro must be enclosed in double quotation marks ( " "). For example, either form of the following command-line macro is allowed:

```
NMAKE "LINKCMD = LINK /MAP"
NMAKE LINKCMD="LINK /MAP"
```

However, the following form of the same macro is not permitted. It contains spaces that are not enclosed by quotation marks:

```
NMAKE LINKCMD = "LINK /MAP"
```

## Null Macros and Undefined Macros

An undefined macro is not the same thing as a macro defined to be null. Both kinds of macros expand to a null string. However, a macro defined to be null is still considered to be defined when used with preprocessing directives such as **!IFDEF**. A macro name can be “undefined” in a makefile by using the **!UNDEF** preprocessing directive. (For information on **!IFDEF** and **!UNDEF**, see “Preprocessing Directives” on page 572).

To define a macro to be null:

- ◆ In a makefile or TOOLS.INI, specify zero or more spaces between the equal sign (=) and the end of the line, as in the following:

```
LINKOPTIONS =
```

- ◆ On the command line or in a command file, specify zero or more spaces enclosed in double quotation marks (" "), or specify the entire null definition enclosed in double quotation marks, as in either of the following:

```
LINKOPTIONS=" "
"LINKOPTIONS ="
```

To undefine a macro in a makefile or in TOOLS.INF, use the **!UNDEF** preprocessing directive, as in:

```
!UNDEF LINKOPTIONS
```

## Using Macros

To use a macro (defined or not), enclose its name in parentheses preceded by a dollar sign (\$), as follows:

```
$(macroname)
```

No spaces are allowed. For example, you can use the LINKCMD macro defined as

```
LINKCMD = LINK /map
```

by specifying

```
$(LINKCMD)
```

NMAKE replaces the specification \$(LINKCMD) with LINK /map.

If the name you use as a macro has never been defined, or was previously defined but is now undefined, NMAKE treats that name as a null string. No error occurs.

The parentheses are optional if *macroname* is a single character. For example, \$L is equivalent to \$(L). However, parentheses are recommended for consistency and to avoid possible errors.

### Example

The following makefile defines and uses three macros:

```
program = sample
L       = LINK
OPTIONS =

$(program).exe : $(program).obj
    $(L) $(OPTIONS) $(program).obj;
```

NMAKE interprets the description block as

```
sample.exe : sample.obj
    LINK sample.obj;
```

NMAKE replaces every occurrence of \$(program) with sample, every instance of \$(L) with LINK, and every instance of \$(OPTIONS) with a null string.

## Special Macros

NMAKE provides several special macros to represent various filenames and commands. One use for these macros is in the predefined inference rules. (For more information, see “Predefined Inference Rules” on page 567.) Like user-defined macro names, special macro names are case sensitive. For example, NMAKE interprets CC and cc as different macro names.

The following sections describe the four categories of special macros. The filename macros offer a convenient representation of filenames from a dependency line. The recursion macros allow you to call NMAKE from within your makefile. The command macros and options macros make it convenient for you to invoke the Microsoft language compilers.

## Filename Macros

NMAKE provides macros that are predefined to represent filenames. The filenames are as you have specified them in the dependency line and not the full specification of the filenames as they exist on disk. As with all one-character macros, these do not need to be enclosed in parentheses. (The `$$@` and `$$$` macros are exceptions to the parentheses rule for macros; they do not require parentheses even though they contain two characters.)

`$@`

The current target's full name (path, base name, and extension), as currently specified.

`$$@`

The current target's full name (path, base name, and extension), as currently specified. This macro is valid only for specifying a dependent in a dependency line.

`$*`

The current target's path and base name minus the file extension.

`$$$`

All dependents of the current target.

`$?`

All dependents that have a later time stamp than the current target.

`$<`

The dependent file that has a later time stamp than the current target. You can use this macro only in commands in inference rules.

### Example 1

The following example uses the `$?` macro, which represents all dependents that have changed more recently than the target. The `!` command modifier causes NMAKE to execute a command once for each dependent in the list. As a result, the `LIB` command is executed up to three times, each time replacing a module with a newer version.

```
trig.lib : sin.obj cos.obj arctan.obj
    !LIB trig.lib -+${?};
```

### Example 2

In the next example, NMAKE updates a file in another directory by replacing it with a file of the same name from the current directory. The `$$@` macro is used to represent the current target's full name.

```
# File in objects directory depends on version in current directory
DIR = c:\objects
$(DIR)\a.obj : a.obj
    COPY a.obj $$@
```

### Modifying Filename Macros

You can append one of the modifiers in the following table to any of the filename macros to extract part of a filename. If you add one of these modifiers to the macro, you must enclose the macro name and the modifier in parentheses.

Modifier	Resulting Filename Part
<b>D</b>	Drive plus directory
<b>B</b>	Base name
<b>F</b>	Base name plus extension
<b>R</b>	Drive plus directory plus base name

### Example 1

Assume that `$$@` represents the target `C:\SOURCE\PROG\SORT.OBJ`. The following table shows the effect of combining each modifier with `$$@`:

Macro Reference	Value
<code>\$(@D)</code>	<code>C:\SOURCE\PROG</code>
<code>\$(@F)</code>	<code>SORT.OBJ</code>
<code>\$(@B)</code>	<code>SORT</code>
<code>\$(@R)</code>	<code>C:\SOURCE\PROG\SORT</code>

If `$$@` has the value `SORT.OBJ` without a preceding directory, the value of `$(@R)` is `SORT`, and the value of `$(@D)` is a period (`.`) to represent the current directory.

### Example 2

The following example uses the **F** modifier to specify a file of the same name in the current directory:

```
# Files in objects directory depend on versions in current directory
DIR = c:\objects
$(DIR)\a.obj $(DIR)\b.obj $(DIR)\c.obj : $$(@F)
    COPY $(@F) $$@
```

---

**Note** For another way to represent components of a filename, see “Filename-Parts Syntax” on page 546.

---

## Recursion Macros

There are three macros that you can use when you want to call NMAKE recursively from within a makefile. These macros can make recursion more efficient.

### MAKE

Defined as the name which you specified to the operating system when you ran NMAKE; this name is `NMAKE` unless you have renamed the `NMAKE.EXE` utility file. Use this macro to call NMAKE recursively. The `/N` command-line option to prevent execution of commands does not prevent this command from executing. It is recommended that you do not redefine **MAKE**.

### MAKEDIR

Defined as the current directory when NMAKE was called.

### MAKEFLAGS

Defined as the NMAKE options currently in effect. This macro is passed automatically when you call NMAKE recursively. However, specification of this macro when invoking recursion is harmless; thus, you can use older makefiles that specify this macro. You cannot redefine **MAKEFLAGS**. To change the `/D`, `/I`, `/N`, and `/S` options within a makefile, use the preprocessing directive **!CMDSWITCHES**. (See “Preprocessing Directives” on page 572.) To add other options to the ones already in effect for NMAKE when recursing, specify them as part of the recursion command.

## Calling NMAKE Recursively

In a commands block, you can specify a call to NMAKE itself. Either invoke the **MAKE** macro or specify NMAKE literally. The following NMAKE information is available to the called NMAKE session during recursion:

- ◆ Environment-variable macros (see “Inherited Macros” on page 563). To cause all macros to be inherited, specify the `/V` option.
- ◆ The **MAKEFLAGS** macro. If **.IGNORE** (or **!CMDSWITCHES +I**) is set, **MAKEFLAGS** contains an `I` when it is passed to the recursive call. Likewise, if **.SILENT** (or **!CMDSWITCHES +S**) is set, **MAKEFLAGS** contains an `S` when passed to the call.
- ◆ Macros specified on the command line for the recursive call.
- ◆ All information in `TOOLS.INI`.

Inference rules defined in the makefile are not passed to the called NMAKE session. Settings for **.SUFFIXES** and **.PRECIOUS** are also not inherited. However, you can make **.SUFFIXES**, **.PRECIOUS**, and all inference rules available to the recursive call either by specifying them in TOOLS.INI or by placing them in a file that is specified in an **!INCLUDE** directive in the makefile for each NMAKE session.

### Example

The **MAKE** macro is useful for building different versions of a program. The following makefile calls NMAKE recursively to build targets in the \VERS1 and \VERS2 directories.

```
all : vers1 vers2

vers1 :
    cd \vers1
    $(MAKE)
    cd ..

vers2 :
    cd \vers2
    $(MAKE) /F vers2.mak
    cd ..
```

If the dependency containing `vers1` as a target is executed, NMAKE performs the commands to change to the \VERS1 directory and call itself recursively using the MAKEFILE in that directory. If the dependency containing `vers2` as a target is executed, NMAKE changes to the \VERS2 directory and calls itself using the file VERS2.MAK in that directory.

### Command Macros

NMAKE predefines several macros to represent commands for Microsoft products. You can use these macros as commands in either a description block or an inference rule; they are automatically used in NMAKE's predefined inference rules. (See "Inference Rules" on page 563.) You can redefine these macros to represent part or all of a command line, including options.

#### AS

Defined as `m1`, the command to run the Microsoft Macro Assembler

#### BC

Defined as `bc`, the command to run the Microsoft Basic Compiler

#### CC

Defined as `c1`, the command to run the Microsoft C Compiler

#### COBOL

Defined as `cobol`, the command to run the Microsoft COBOL Compiler



**CPP**

Defined as `c1`, the command to run the Microsoft C++ Compiler

**CXX**

Defined as `c1`, the command to run the Microsoft C++ Compiler

**FOR**

Defined as `f1`, the command to run the Microsoft FORTRAN Compiler

**PASCAL**

Defined as `p1`, the command to run the Microsoft Pascal Compiler

**RC**

Defined as `rc`, the command to run the Microsoft Resource Compiler

## Options Macros

The following macros represent options to be passed to the commands for invoking the Microsoft language compilers. These macros are used automatically in the predefined inference rules. (See “Predefined Inference Rules” on page 567.) By default, these macros are undefined. You can define them to mean the options you want to pass to the compilers, and you can use these macros in commands in description blocks and inference rules. As with all macros, the options macros can be used even if they are undefined; a macro that is undefined or defined to be a null string generates a null string where it is used.

**AFLAGS**

Passes options to the Microsoft Macro Assembler

**BFLAGS**

Passes options to the Microsoft Basic Compiler

**CFLAGS**

Passes options to the Microsoft C Compiler

**COBFLAGS**

Passes options to the Microsoft COBOL Compiler

**CPPFLAGS**

Passes options to the Microsoft C++ Compiler

**CXXFLAGS**

Passes options to the Microsoft C++ Compiler

**FFLAGS**

Passes options to the Microsoft FORTRAN Compiler

**PFLAGS**

Passes options to the Microsoft Pascal Compiler

**RFLAGS**

Passes options to the Microsoft Resource Compiler

## Substitution Within Macros

Just as macros allow you to substitute text in a makefile, you can also substitute text within a macro itself. The substitution applies only to the current use of the macro and does not modify the original macro definition. To substitute text within a macro, use the following syntax:

```
$(macroname:string1=string2)
```

Every occurrence of *string1* is replaced by *string2* in the macro *macroname*. Do not put any spaces or tabs before the colon. Spaces that appear after the colon are interpreted as part of the string in which they occur. If *string2* is a null string, all occurrences of *string1* are deleted from the *macroname* macro.

Macro substitution is literal and case sensitive. This means that the case as well as the characters in *string1* must match the target string in the macro exactly, or the substitution is not performed. This also means that *string2* is substituted exactly as it is specified. Because substitution is literal, the strings cannot contain macro expansions.

### Example 1

The following makefile illustrates macro substitution:

```
SOURCES = project.c one.c two.c

project.exe : $(SOURCES:.c=.obj)
    LINK $**;
```

The predefined macro `$**` stands for the names of all the dependent files (See “Filename Macros” on page 555.) When this makefile is run, NMAKE executes the following command:

```
LINK project.obj one.obj two.obj;
```

The macro substitution does not alter the `SOURCES` macro definition; if it is used again elsewhere in the makefile, `SOURCES` has its original value as it was defined.

### Example 2

If the macro `OBJS` is defined as

```
OBJS = ONE.OBJ TWO.OBJ THREE.OBJ
```

you can replace each space in the defined value of `OBJS` with a space, followed by a plus sign, followed by a newline character, by using

```
$(OBJS: = +^
)
```

The caret ( `^` ) tells NMAKE to treat the end of the line as a literal newline character. The expanded macro after substitution is:

```
ONE.OBJ +
TWO.OBJ +
THREE.OBJ
```

This example is useful for creating response files.

## Substitution Within Predefined Macros

You can also substitute text in any predefined macro (except `$$@`) using the same syntax as for other macros.

The command in the following description block makes a substitution within the predefined macro `$@`, which represents the full name of the current target. Note that although `$@` is a single-character macro, when it is used in a substitution, it must be enclosed in parentheses.

```
target.abc : depend.xyz
    echo $(@:targ=blank)
```

NMAKE substitutes `blank` for `targ` in the target, resulting in the string `blanket.abc`. If dependent `depend.xyz` has a later time stamp than target `target.abc`, then NMAKE executes the command

```
echo blanket.abc
```

## Environment-Variable Macros

When NMAKE executes, it inherits macro definitions equivalent to every environment variable that existed before the start of the NMAKE session. If a variable such as `LIB` or `INCLUDE` has been set in the operating-system environment, you can use its value as if you had specified an NMAKE macro with the same name and value. The inherited macro names are converted to uppercase. Inheritance occurs before preprocessing. The `/E` option causes macros inherited from environment variables to override any macros with the same name in the makefile.

You can redefine environment-variable macros the same way that you define or redefine other macros. Changing a macro does not change the corresponding environment variable; to change the variable, use a SET command. Also, using the SET command to change an environment variable in an NMAKE session does not change the corresponding macro; to change the macro, use a macro definition.

If an environment variable has not been set in the operating-system environment, it cannot be set using a macro definition. However, you can use a SET command in the NMAKE session to set the variable. The variable is then in effect for the rest of the NMAKE session unless redefined or cleared by a later SET command. A SET definition that appears in a makefile does not create a corresponding macro for that variable name; if you want a macro for an environment variable that is created during an NMAKE session, you must explicitly define the macro in addition to setting the variable.

If an environment variable is defined as a string that would be syntactically incorrect in a makefile, NMAKE does not create a macro from that variable. No warning is generated.

---

**Warning** If an environment variable contains a dollar sign (\$), NMAKE interprets it as the beginning of a macro invocation. The resulting macro expansion can cause unexpected behavior and possibly an error.

---

### Example

The following makefile redefines the environment-variable macro called LIB:

```
LIB = c:\tools\lib

sample.exe : sample.obj
    LINK sample;
```

No matter what value the environment variable LIB had before, it has the value c:\tools\lib when NMAKE executes the LINK command in this description block. Redefining the inherited macro does not affect the original environment variable; when NMAKE terminates, LIB still has its original value.

If LIB is not defined before the NMAKE session, the LIB macro definition in the preceding example does not set a LIB environment variable for the LINK command. To do this, use the following makefile:

```
sample.exe : sample.obj
    SET LIB=c:\tools.lib
    LINK sample;
```

## Inherited Macros

When NMAKE is called recursively, the only macros that are inherited by the called NMAKE are those defined on the command line or in environment variables. Macros defined in the makefile are not inherited when NMAKE is called recursively. There are several ways to pass macros to a recursive NMAKE session:

- ◆ Run NMAKE with the `/V` option. This option causes all macros to be inherited by the recursively called NMAKE. You can use this option on the NMAKE command for the entire session, or you can specify it in a command for a recursive NMAKE call to affect just the specified recursive session.
- ◆ Use the SET command before the recursive call to set an environment variable before the called NMAKE session.
- ◆ Define a macro on the command line for the recursive call.
- ◆ Define a macro in the TOOLS.INI file. Each time NMAKE is recursively called, it reads TOOLS.INI.

## Precedence Among Macro Definitions

If you define the same macro name in more than one place, NMAKE uses the macro with the highest precedence. The precedence from highest to lowest is as follows:

1. A macro defined on the command line
2. A macro defined in a makefile or include file
3. An inherited environment-variable macro
4. A macro defined in the TOOLS.INI file
5. A predefined macro, such as **AS** or **CC**

The `/E` option causes macros inherited from environment variables to override any macros with the same name in the makefile. The **!UNDEF** directive in a makefile overrides a macro defined on the command line.

## Inference Rules

Inference rules are templates that define how a file with one extension is created from a file with another extension. NMAKE uses inference rules to supply commands for updating targets and to infer dependents for targets. In the dependency tree, inference rules cause targets to have inferred dependents as well as explicitly specified dependents; see “Inferred Dependents” on page 569. The **.SUFFIXES** list determines priorities for applying inference rules; see “Dot Directives” on page 570.

Inference rules provide a convenient shorthand for common operations. For instance, you can use an inference rule to avoid repeating the same command in several description blocks. You can define your own inference rules or use predefined inference rules. Inference rules can be specified in the makefile or in `TOOLS.INI`.

Inference rules can be used in the following situations:

- ◆ If NMAKE encounters a description block that has no commands, it checks the **.SUFFIXES** list and the files in the current or specified directory and then searches for an inference rule that matches the extensions of the target and an existing dependent file with the highest possible **.SUFFIXES** priority.
- ◆ If a dependent file doesn't exist and is not listed as a target in another description block, NMAKE looks for an inference rule that shows how to create the missing dependent from another file with the same base name.
- ◆ If a target has no dependents and its description block has no commands, NMAKE can use an inference rule to create the target.
- ◆ If a target is specified on the command line and there is no makefile (or no mention of the target in the makefile), inference rules are used to build the target.

If a target is used in more than one single-colon dependency, an inference rule might not be applied as expected; see “Accumulating Targets in Dependencies” on page 539.

## Inference Rule Syntax

To define an inference rule, use the following syntax:

```
.fromext.toext:  
  commands
```

The first line lists two extensions: *fromext* represents the extension of a dependent file, and *toext* represents the extension of a target file. Extensions are not case sensitive. Macros can be invoked to represent *fromext* and *toext*; the macros are expanded during preprocessing.

The period (.) preceding *fromext* must appear at the beginning of the line. The colon (: ) can be preceded by zero or more spaces or tabs; it can be followed only by spaces or tabs, a semicolon (;) to specify a command, a number sign (#) to specify a comment, or a newline character. No other spaces are allowed.

The rest of the inference rule gives the commands to be run if the dependency is out-of-date. Use the same rules for commands in inference rules as in description blocks. (See “Commands” on page 543.)

An inference rule can be used only when a target and dependent have the same base name. You cannot use a rule to match multiple targets or dependents. For example, you cannot define an inference rule that replaces several modules in a library because all but one of the modules must have a different base name from the target library.

Inference rules can exist only for dependents with extensions that are listed in the **.SUFFIXES** directive. (For information on **.SUFFIXES**, see “Dot Directives” on page 570.) If an out-of-date dependency does not have a commands block, and if the **.SUFFIXES** list contains the extension of the dependent, NMAKE looks for an inference rule matching the extensions of the target and of an existing file in the current or specified directory. If more than one rule matches existing dependent files, NMAKE uses the order of the **.SUFFIXES** list to determine which rule to invoke. Priority in the list descends from left to right. NMAKE may invoke a rule for an inferred dependent even if an explicit dependent is specified; for more information, see “Inferred Dependents” on page 569.

Inference rules tell NMAKE how to build a target specified on the command line if no makefile is provided or if the makefile does not have a dependency containing the specified target. When a target is specified on the command line and NMAKE cannot find a description block to run, it looks for an inference rule to tell it how to build the target. You can run NMAKE without a makefile if the inference rules that are predefined or defined in TOOLS.INI are all you need for your build.

## Inference Rule Search Paths

The inference-rule syntax described previously tells NMAKE to look for the specified files in the current directory. You can also specify directories to be searched by NMAKE when it looks for files. An inference rule that specifies paths has the following syntax:

```
{frompath},fromext{topath}.toext:  
  commands
```

No spaces are allowed. The *frompath* directory must match the directory specified for the dependent file; similarly, *topath* must match the target’s directory specification. For NMAKE to apply an inference rule to a dependency, the paths in the dependency line must match the paths specified in the inference rule exactly. For example, if the current directory is called PROJ, the inference rule

```
{..\proj}.exe{..\proj}.obj:
```

does not apply to the dependency

```
project1.exe : project1.obj
```

If you use a path on one extension in the inference rule, you must use paths on both. You can specify the current directory by either a period (.) or an empty pair of braces ({}).

You can specify only one path for each extension in an inference rule. To specify more than one path, you must create a separate inference rule for each path.

Macros can be invoked to represent *frompath* and *topath*; the macros are expanded during preprocessing.

## User-Defined Inference Rules

The following examples illustrate several ways to write inference rules.

### Example 1

The following makefile contains an inference rule and a minimal description block:

```
.c.obj :
    cl /c $<

sample.obj :
```

The inference rule tells NMAKE how to build a .OBJ file from a .C file. The predefined macro \$< represents the name of a dependent that has a later time stamp than the target. The description block lists only a target, SAMPLE.OBJ; there is no dependent or command. However, given the target's base name and extension, plus the inference rule, NMAKE has enough information to build the target.

After checking to be sure that .c is one of the extensions in the .SUFFIXES list, NMAKE looks for a file with the same base name as the target and with the .C extension. If SAMPLE.C exists (and no files with higher-priority extensions exist), NMAKE compares its time to that of SAMPLE.OBJ. If SAMPLE.C has changed more recently, NMAKE compiles it using the CL command listed in the inference rule:

```
cl /c sample.c
```

### Example 2

The following inference rule compares a .C file in the current directory with the corresponding .OBJ file in another directory:

```
{.}.c(c:\objects).obj :
    cl /c $<;
```

The path for the .C file is represented by a period. A path for the dependent extension is required because one is specified for the target extension.



This inference rule matches a dependency line containing the same combination of paths, such as:

```
c:\objects\test.obj : test.c
```

This rule does not match a dependency line such as:

```
test.obj : test.c
```

In this case, NMAKE uses the predefined inference rule for .c.obj when building the target.

### Example 3

The following inference rule uses macros to specify paths in an inference rule:

```
C_DIR = proj1src
OBJ_DIR = proj1obj
{$(C_DIR)}.c{$(OBJ_DIR)}.obj :
    cl /c $
```

If the macros are redefined, NMAKE uses the definition that is current at that point during preprocessing. To reuse an inference rule with different macro definitions, you must repeat the rule after the new definition:

```
C_DIR = proj1src
OBJ_DIR = proj1obj
{$(C_DIR)}.c{$(OBJ_DIR)}.obj :
    cl /c $<
C_DIR = proj2src
OBJ_DIR = proj2obj
{$(C_DIR)}.c{$(OBJ_DIR)}.obj :
    cl /c $<
```

## Predefined Inference Rules

NMAKE provides predefined inference rules containing commands for creating object, executable, and resource files. Table 16.1 describes the predefined inference rules.

**Table 16.1 Predefined Inference Rules**

Rule	Command	Default Action
.asm.exe	\$(AS) \$(AFLAGS) \$*.asm	ML \$*.ASM
.asm.obj	\$(AS) \$(AFLAGS) /c \$*.asm	ML /c \$*.ASM
.c.exe	\$(CC) \$(CFLAGS) \$*.c	CL \$*.C
.c.obj	\$(CC) \$(CFLAGS) /c \$*.c	CL /c \$*.C
.cpp.exe	\$(CPP) \$(CPPFLAGS) \$*.cpp	CL \$*.CPP

**Table 16.1** Predefined Inference Rules (*continued*)

Rule	Command	Default Action
.cpp.obj	\$(CPP) \$(CPPFLAGS) /c \$*.cpp	CL /c \$*.CPP
.cxx.exe	\$(CXX) \$(CXXFLAGS) \$*.cxx	CL \$*.CXX
.cxx.obj	\$(CXX) \$(CXXFLAGS) /c \$*.cxx	CL /c \$*.CXX
.bas.obj	\$(BC) \$(BFLAGS) \$*.bas;	BC \$*.BAS;
.cbl.exe	\$(COBOL) \$(COBFLAGS) \$*.cbl, \$*.exe;	COBOL \$*.CBL, \$*.EXE;
.cbl.obj	\$(COBOL) \$(COBFLAGS) \$*.cbl;	COBOL \$*.CBL;
.for.exe	\$(FOR) \$(FFLAGS) \$*.for	FL \$*.FOR
.for.obj	\$(FOR) /c \$(FFLAGS) \$*.for	FL /c \$*.FOR
.pas.exe	\$(PASCAL) \$(PFLAGS) \$*.pas	PL \$*.PAS
.pas.obj	\$(PASCAL) /c \$(PFLAGS) \$*.pas	PL /c \$*.PAS
.rc.res	\$(RC) \$(RFLAGS) /r \$*	RC /r \$*

For example, assume you have the following makefile:

```
sample.exe :
```

This description block lists a target without any dependents or commands. NMAKE looks at the target's extension (.EXE) and searches for an inference rule that describes how to create an .EXE file. Table 16.1 shows that more than one inference rule exists for building an .EXE file. NMAKE uses the order of the extensions appearing in the **.SUFFIXES** list to determine which rule to invoke. It then looks in the current or specified directory for a file that has the same base name as the target `sample` and one of the extensions in the **.SUFFIXES** list; it checks the extensions one by one until it finds a matching dependent file in the directory.

For example, if a file called `SAMPLE.ASM` exists, NMAKE applies the `.asm.exe` inference rule. If both `SAMPLE.C` and `SAMPLE.ASM` exist, and if `.c` appears before `.asm` in the **.SUFFIXES** list, NMAKE uses the `.c.exe` inference rule to compile `SAMPLE.C` and links the resulting file `SAMPLE.OBJ` to create `SAMPLE.EXE`.

---

**Note** By default, the options macros (**AFLAGS**, **CFLAGS**, and so on) are undefined. As explained in "Using Macros" on page 554, this causes no problem; NMAKE replaces an undefined macro with a null string. Because the predefined options macros are included in the inference rules, you can define these macros and have their assigned values passed automatically to the predefined inference rules.

---

## Inferred Dependents

NMAKE can assume an “inferred dependent” for a target if there is an applicable inference rule. An inference rule is applicable if:

- ◆ The *toext* in the rule matches the extension of the target being evaluated.
- ◆ The *fromext* in the rule matches the extension of a file that has the same base name as the target and that exists in the current or specified directory.
- ◆ The *fromext* is in the **.SUFFIXES** list.
- ◆ No other *fromext* in a matching rule is listed in **.SUFFIXES** with a higher priority.
- ◆ No explicitly specified dependent has a higher priority extension.

If an existing dependent matches an inference rule and has an extension with a higher **.SUFFIXES** priority, NMAKE does not infer a dependent.

NMAKE does not necessarily execute the commands block in an inference rule for an inferred dependent. If the target’s description block contains commands, NMAKE executes the description block’s commands and not the commands in the inference rule. The effect of an inferred dependent is illustrated in the following example:

```
project.obj :
    cl /Zi /c project.c
```

If a makefile contains this description block and if the current directory contains a file named PROJECT.C and no other files, NMAKE uses the predefined inference rule for `.c.obj` to infer the dependent `project.c`. It does not execute the predefined rule’s command, `cl /c project.c`. Instead, it runs the command specified in the makefile.

Inferred dependents can cause unexpected side effects. In the following examples, assume that both PROJECT.ASM and PROJECT.C exist and that **.SUFFIXES** contains the default setting. If the makefile contains

```
project.obj : project.c
```

NMAKE infers the dependent `project.asm` ahead of `project.c` because **.SUFFIXES** lists `.asm` before `.c` and because a rule for `.asm.obj` exists. If either PROJECT.ASM or PROJECT.C is out-of-date, NMAKE executes the commands in the rule for `.asm.obj`.

However, if the dependency in the preceding example is followed by a commands block, NMAKE executes those commands and not the commands in the inference rule for the inferred dependent.

Another side effect occurs because NMAKE builds a target if it is out-of-date with respect to any of its dependents, whether explicitly specified or inferred. For example, if PROJECT.OBJ is up-to-date with respect to PROJECT.C but not with respect to PROJECT.ASM, and if the makefile contains

```
project.obj : project.c
    cl /Zi /c project.c
```

NMAKE infers the dependent `project.asm` and updates the target using the command specified in this description block.

## Precedence Among Inference Rules

If the same inference rule is defined in more than one place, NMAKE uses the rule with the highest precedence. The precedence from highest to lowest is as follows:

1. An inference rule defined in the makefile. If more than one rule is defined, the last rule applies.
2. An inference rule defined in the TOOLS.INI file. If more than one rule is defined, the last rule applies.
3. A predefined inference rule.

User-defined inference rules always override predefined inference rules. NMAKE uses a predefined inference rule only if no user-defined inference rule exists for a given target and dependent.

If two inference rules match a target's extension and a dependent is not specified, NMAKE uses the inference rule whose dependent's extension appears first in the **.SUFFIXES** list.

## Directives

NMAKE provides several ways to control the NMAKE session through dot directives and preprocessing directives. Directives are instructions to NMAKE that are placed in the makefile or in TOOLS.INI. NMAKE interprets dot directives and preprocessing directives and applies the results to the makefile before processing dependencies and commands.

## Dot Directives

Dot directives must appear outside a description block and must appear at the beginning of a line. Dot directives begin with a period (.) and are followed by a colon (:). Spaces and tabs can precede and follow the colon. These directive names are case sensitive and must be uppercase.

**.IGNORE :**

Ignores nonzero exit codes returned by programs called from the makefile. By default, NMAKE halts if a command returns a nonzero exit code. This directive affects the makefile from the place it is specified to the end of the file. To turn it off again, use the **!CMDSWITCHES** preprocessing directive. To ignore the exit code for a single command, use the dash (-) command modifier. To ignore exit codes for an entire file, invoke NMAKE with the **/I** option.

**.PRECIOUS :** *targets*

Tells NMAKE not to delete *targets* if the commands that build them are interrupted. This directive has no effect if a command is interrupted and handles the interrupt by deleting the file. Separate the target names with one or more spaces or tabs. By default, NMAKE deletes the target if building was interrupted by CTRL+C or CTRL+BREAK. Multiple specifications are cumulative; each use of **.PRECIOUS** applies to the entire makefile.

**.SILENT :**

Suppresses display of the command lines as they are executed. By default, NMAKE displays the commands it invokes. This directive affects the makefile from the place it is specified to the end of the file. To turn it off again, use the **!CMDSWITCHES** preprocessing directive. To suppress display of a single command line, use the @ command modifier. To suppress the command display for an entire file, invoke NMAKE with the **/S** option.

**.SUFFIXES :** *list*

Lists file suffixes (extensions) for NMAKE to try to match when it attempts to apply an inference rule. (For details about using **.SUFFIXES**, see “Inference Rules” on page 563.) The list is predefined as follows:

```
.SUFFIXES : .exe .obj .asm .c .cpp .cxx .bas .cbl .for .pas .res .rc
```

To add additional suffixes to the end of the list, specify

**.SUFFIXES :** *suffixlist*

where *suffixlist* is a list of the additional suffixes, separated by one or more spaces or tabs. To clear the list, specify

```
.SUFFIXES :
```

without extensions. To change the list order or to specify an entirely new list, you must clear the list and specify a new setting. To see the current setting, run NMAKE with the **/P** option.

## Preprocessing Directives

NMAKE preprocessing directives are similar to compiler preprocessing directives. You can use several of the directives to conditionally process the makefile. With other preprocessing directives you can display error messages, include other files, undefine a macro, and turn certain options on or off. NMAKE reads and executes the preprocessing directives before processing the makefile as a whole.

Preprocessing directives begin with an exclamation point (!), which must appear at the beginning of the line. Zero or more spaces or tabs can appear between the exclamation point and the directive keyword; this allows indentation for readability. These directives (and their keywords and operators) are not case sensitive.

### **!CMDSWITCHES** {+|-}opt...

Turns on or off one or more options. (For descriptions of options, see page 529.) Specify an operator, either a plus sign (+) to turn options on or a minus sign (-) to turn options off, followed by one or more letters representing options. Letters are not case sensitive. Do not specify the slash (/). Separate the directive from the operator by one or more spaces or tabs; no space can appear between the operator and the options. To turn on some options and turn off other options, use separate specifications of the **!CMDSWITCHES** directives.

All options with the exception of /F, /HELP, /NOLOGO, /X, and /? can appear in **!CMDSWITCHES** specifications in TOOLS.INI. In a makefile, only the letters D, I, N, and S can be specified. If **!CMDSWITCHES** is specified within a description block, the changes do not take effect until the next description block. This directive updates the **MAKEFLAGS** macro; the changes are inherited during recursion.

### **!ERROR** text

Displays *text* to standard error in the message for error U1050, then stops the NMAKE session. This directive stops the build even if /K, /I, **!IGNORE**, **!CMDSWITCHES**, or the dash (-) command modifier is used. Spaces or tabs before *text* are ignored.

### **!MESSAGE** text

Displays *text* to standard output, then continues the NMAKE session. Spaces or tabs before *text* are ignored.

### **!INCLUDE** [**<**]filename[**>**]

Reads and evaluates the file *filename* as a makefile before continuing with the current makefile. NMAKE first looks for *filename* in the current directory if *filename* is specified without a path; if a path is specified, NMAKE looks in the specified directory. Next, if the **!INCLUDE** directive is itself contained in a file that is included, NMAKE looks for *filename* in the parent file's directory; this search is recursive, ending with the original makefile's directory. Finally, if *filename* is enclosed by angle brackets (<>), NMAKE searches in the directories specified by the **INCLUDE** macro. The **INCLUDE** macro is initially set to the value of the **INCLUDE** environment variable.

**!IF** *constantexpression*

Processes the statements between the **!IF** and the next **!ELSE** or **!ENDIF** if *constantexpression* evaluates to a nonzero value.

**!IFDEF** *macroname*

Processes the statements between the **!IFDEF** and the next **!ELSE** or **!ENDIF** if *macroname* is defined. NMAKE considers a macro with a null value to be defined.

**!IFNDEF** *macroname*

Processes the statements between the **!IFNDEF** and the next **!ELSE** or **!ENDIF** if *macroname* is not defined.

**!ELSE** [[**!IF** *constantexpression* | **!IFDEF** *macroname* | **!IFNDEF** *macroname*]]

Processes the statements between the **!ELSE** and the next **!ENDIF** if the preceding **!IF**, **!IFDEF**, or **!IFNDEF** statement evaluated to zero. The optional keywords give further control of preprocessing.

**!ELSEIF**

Synonym for **!ELSE IF**.

**!ELSEIFDEF**

Synonym for **!ELSE IFDEF**.

**!ELSEIFNDEF**

Synonym for **!ELSE IFNDEF**.

**!ENDIF**

Marks the end of an **!IF**, **!IFDEF**, or **!IFNDEF** block. Anything following **!ENDIF** on the same line is ignored.

**!UNDEF** *macroname*

Undefines a macro by removing *macroname* from NMAKE's symbol table. (For more information, see "Null Macros and Undefined Macros" on page 553.)

**Example**

The following set of directives

```
!IF
!ELSE
!  IF
!  ENDIF
!ENDIF
```

is equivalent to the set of directives

```
!IF
!ELSE IF
!ENDIF
```

## Expressions in Preprocessing

The *constantexpression* used with the **!IF** or **!ELSE IF** directives can consist of integer constants, string constants, or program invocations. You can group expressions by enclosing them in parentheses. NMAKE treats numbers as decimals unless they start with 0 (octal) or 0x (hexadecimal).

Expressions in NMAKE use C-style signed long integer arithmetic; numbers are represented in 32-bit two's-complement form and are in the range -2147483648 to 2147483647.

Two unary operators evaluate a condition and return a logical value of true (1) or false (0):

### **DEFINED** (*macroname*)

Evaluates to true if *macroname* is defined. In combination with the **!IF** or **!ELSE IF** directives, this operator is equivalent to the **!IFDEF** or **!ELSE IFDEF** directives. However, unlike these directives, **DEFINED** can be used in complex expressions using binary logical operators.

### **EXIST** (*path*)

Evaluates to true if *path* exists. **EXIST** can be used in complex expressions using binary logical operators. If *path* contains spaces (allowed in some file systems), enclose it in double quotation marks.

Integer constants can use the unary operators for numerical negation (-), one's complement (~), and logical negation (!).

Constant expressions can use any binary operator listed in Table 16.2. To compare two strings, use the equality (==) operator and the inequality (!=) operator. Enclose strings in double quotation marks.

**Table 16.2 Binary Operators for Preprocessing**

Operator	Description
+	Addition
-	Subtraction
*	Multiplication
/	Division
%	Modulus
&	Bitwise AND
	Bitwise OR
^	Bitwise XOR
&&	Logical AND
	Logical OR



**Table 16.2 Binary Operators for Preprocessing** (*continued*)

Operator	Description
<<	Left shift
>>	Right shift
==	Equality
!=	Inequality
<	Less than
>	Greater than
<=	Less than or equal to
>=	Greater than or equal to

**Example**

The following example shows how preprocessing directives can be used to control whether the linker inserts debugging information into the .EXE file:

```

!INCLUDE <infrules.txt>
!CMDSWITCHES +D
winner.exe : winner.obj
!IF DEFINED(debug)
!   IF "$(debug)"=="y"
           LINK /CO winner.obj;
!   ELSE
           LINK winner.obj;
!   ENDIF
!ELSE
!   ERROR Macro named debug is not defined.
!ENDIF

```

In this example, the **!INCLUDE** directive inserts the INFRULES.TXT file into the makefile. The **!CMDSWITCHES** directive sets the /D option, which displays the time stamps of the files as they are checked. The **!IF** directive checks to see if the macro `debug` is defined. If it is defined, the next **!IF** directive checks to see if it is set to `y`. If it is, NMAKE reads the **LINK** command with the /CO option; otherwise, NMAKE reads the **LINK** command without /CO. If the `debug` macro is not defined, the **!ERROR** directive prints the specified message and NMAKE stops.

**Executing a Program in Preprocessing**

You can invoke a program or command from within NMAKE and use its exit code during preprocessing. NMAKE executes the command during preprocessing, and it replaces the specification in the makefile with the command's exit code. A nonzero exit code usually indicates an error. You can use this value in an expression to control preprocessing.

Specify the command, including any arguments, within brackets ( [ ] ). You can use macros in the command specification; NMAKE expands the macro before executing the command.

### Example

The following part of a makefile tests the space on disk before continuing the NMAKE session:

```
!IF [c:\util\checkdisk] != 0
!   ERROR Not enough disk space; NMAKE terminating.
!ENDIF
```

## Sequence of NMAKE Operations

When you write a complex makefile, it can be helpful to know the sequence in which NMAKE performs operations. This section describes those operations and their order.

When you run NMAKE from the command line, NMAKE's first task is to find the makefile:

1. If the /F option is used, NMAKE searches for the filename specified in the option. If NMAKE cannot find that file, it returns an error.
2. If the /F option is not used, NMAKE looks for a file named MAKEFILE in the current directory. If there are targets on the command line, NMAKE builds them according to the instructions in MAKEFILE. If there are no targets on the command line, NMAKE builds only the first target it finds in MAKEFILE.
3. If NMAKE cannot find MAKEFILE, NMAKE looks for target files on the command line and attempts to build them using inference rules (either defined by the user in TOOLS.INI or predefined by NMAKE). If no target is specified, NMAKE returns an error.

NMAKE then assigns macro definitions with the following precedence (highest to lowest):

1. Macros defined on the command line
2. Macros defined in a makefile or include file
3. Inherited macros
4. Macros defined in the TOOLS.INI file
5. Predefined macros (such as **CC** and **RFLAGS**)

Macro definitions are assigned first in order of priority and then in the order in which NMAKE encounters them. For example, a macro defined in an include file overrides a macro with the same name from the TOOLS.INI file. Note that a macro within a makefile can be redefined; a macro is valid from the point it is defined until it is redefined or undefined.

NMAKE also assigns inference rules, using the following precedence (highest to lowest):

1. Inference rules defined in a makefile or include file
2. Inference rules defined in the TOOLS.INI file
3. Predefined inference rules (such as .asm.obj)

You can use command-line options to change some of these priorities.

- ◆ The `/E` option allows macros inherited from the environment to override macros defined in the makefile.
- ◆ The `/R` option tells NMAKE to ignore macros and inference rules that are defined in TOOLS.INI or are predefined.

Next, NMAKE evaluates any preprocessing directives. If an expression for conditional preprocessing contains a program in brackets ( [ ] ), the program is invoked during preprocessing and the program's exit code is used in the expression. If an **!INCLUDE** directive is specified for a file, NMAKE preprocesses the included file before continuing to preprocess the rest of the makefile. Preprocessing determines the final makefile that NMAKE reads.

NMAKE is now ready to update the targets. If you specified targets on the command line, NMAKE updates only those targets. If you did not specify targets on the command line, NMAKE updates only the first target in the makefile. If you specify a pseudotarget, NMAKE always updates the target. If you use the `/A` option, NMAKE always updates the target, even if the file is not out-of-date.

NMAKE updates a target by comparing its time stamp to the time stamp of each dependent of that target. A target is out-of-date if any dependent has a later time stamp; if the `/B` option is specified, a target is out-of-date if any dependent has a later or equal time stamp.

If the dependents of the targets are themselves out-of-date or do not exist, NMAKE updates them first. If the target has no explicit dependent, NMAKE looks for an inference rule that matches the target. If a rule exists, NMAKE updates the target using the commands given with the inference rule. If more than one rule applies to the target, NMAKE uses the priority in the **.SUFFIXES** list to determine which inference rule to use.

NMAKE normally stops processing the makefile when a command returns a nonzero exit code. In addition, if NMAKE cannot tell whether the target was built successfully, it deletes the target. The `/I` command-line option, **.IGNORE** directive, **!CMDSWITCHES** directive, and dash (`-`) command modifier all tell NMAKE to ignore error codes and attempt to continue processing. The `/K` option tells NMAKE to continue processing unrelated parts of the build if an error occurs. The **.PRECIOUS** directive prevents NMAKE from deleting a partially created target if you interrupt the build with `CTRL+C` or `CTRL+BREAK`. You can document errors by using the **!ERROR** directive to print descriptive text. The directive causes NMAKE to print some text, then stop the build.

## A Sample NMAKE Makefile

The following example illustrates many of NMAKE's features. The makefile creates an executable file from C-language source files:

```
# This makefile builds SAMPLE.EXE from SAMPLE.C,
# ONE.C, and TWO.C, then deletes intermediate files.

CFLAGS   = /c /AL /Od $(CODEVIEW) # controls compiler options
LFLAGS   = /CO                     # controls linker options
CODEVIEW = /Zi                     # controls debugging information

OBJS = sample.obj one.obj two.obj

all : sample.exe

sample.exe : $(OBJS)
    link $(LFLAGS) @<<sample.lrf
$(OBJS: =+^
)
sample.exe
sample.map;
<<KEEP

sample.obj : sample.c sample.h common.h
    CL $(CFLAGS) sample.c

one.obj : one.c one.h common.h
    CL $(CFLAGS) one.c

two.obj : two.c two.h common.h
    CL $(CFLAGS) two.c
```

```
clean :
    -del *.obj
    -del *.map
    -del *.lrf
```

Assume that this makefile is named SAMPLE.MAK. To invoke it, enter

```
NMAKE /F SAMPLE.MAK all clean
```

NMAKE builds SAMPLE.EXE and deletes intermediate files.

Here is how the makefile works. The `CFLAGS`, `CODEVIEW`, and `LFLAGS` macros define the default options for the compiler, linker, and inclusion of debugging information. You can redefine these options from the command line to alter or delete them. For example,

```
NMAKE /F SAMPLE.MAK CODEVIEW= CFLAGS= all clean
```

creates an .EXE file that does not contain debugging information.

The `OBJS` macro specifies the object files that make up the executable file SAMPLE.EXE, so they can be reused without having to type them again. Their names are separated by exactly one space so that the space can be replaced with a plus sign (+) and a carriage return in the link response file. (This is illustrated in the second example in “Substitution Within Macros” on page 560.)

The `all` pseudotarget points to the real target, `sample.exe`. If you do not specify any target on the command line, NMAKE ignores the `clean` pseudotarget but still builds `all` because `all` is the first target in the makefile.

The dependency line containing the target `sample.exe` makes the object files specified in `OBJS` the dependents of `sample.exe`. The command section of the block contains only link instructions. No compilation instructions are given since they are given explicitly later in the file. (You can also define an inference rule to specify how an object file is to be created from a C source file.)

The `link` command is unusual because the `LINK` parameters and options are not passed directly to `LINK`. Rather, an inline response file is created containing these elements. This eliminates the need to maintain a separate link response file.

The next three dependencies define the relationship of the source code to the object files. The .H (header or include) files are also dependents since any changes to them also require recompilation.

The `clean` pseudotarget deletes unneeded files after a build. The dash (–) command modifier tells NMAKE to ignore errors returned by the deletion commands. If you want to save any of these files, don’t specify `clean` on the command line; NMAKE then ignores the `clean` pseudotarget.

## NMAKE Exit Codes

NMAKE returns an exit code to the operating system or the calling program. A value of 0 indicates execution of NMAKE with no errors. Warnings return exit code 0.

Code	Meaning
0	No error
1	Incomplete build (issued only when /K is used)
2	Program error, possibly due to one of the following: <ul style="list-style-type: none"><li>◆ A syntax error in the makefile</li><li>◆ An error or exit code from a command</li><li>◆ An interruption by the user</li></ul>
4	System error—out of memory
255	Target is not up-to-date (issued only when /Q is used)

# Managing Libraries with LIB

This chapter describes the Microsoft Library Manager (LIB) version 3.20. LIB creates and manages standard libraries, which are used to resolve references to external routines and data during static linking.

## Overview

LIB creates, organizes, and maintains standard libraries. Standard libraries are collections of compiled or assembled object modules that provide a common set of useful routines and data. You use these libraries to provide your program with the routines and data at link time; this is called static linking. After you have linked a program to a library, the program can use a routine or data item exactly as if it were included in the program.

With LIB you can create a library file, add modules to a library, and delete or replace them. You can combine libraries into one library file and copy or move a module to a separate object file. You can also produce a listing of all public symbols in the library modules.

LIB works with the following kinds of files:

- ◆ Object files in the Microsoft Relocatable Object-Module Format (OMF), which is based on the Intel 8086 OMF
- ◆ Standard libraries in Microsoft library format
- ◆ Import libraries created by the Microsoft Import Library Manager (IMPLIB)
- ◆ 286 XENIX archives and Intel-style libraries

This chapter distinguishes between an “object file” and an “object module.” An object file is an independent file that can have a full path and extension (usually .OBJ). An object module is an object file that has been incorporated into a library. Object modules in the library have only base names. For example, SORT is an object-module name, while B:\RUN\SORT.OBJ is an object-file name.

## Running LIB

To run LIB, type LIB at the operating system prompt and press ENTER. You can provide input to LIB in three ways, separately or in combination:

- ◆ Specify input on the command line.
- ◆ Respond to the prompts that LIB displays.
- ◆ Specify a response file that contains the expected input.

## The LIB Command Line

You can run LIB and specify all the input it needs from the command line. The LIB command line has the following form:

```
LIB oldlibrary [options] [commands] [, [listfile] [, [newlibrary] ] ] [;]
```

Fields must appear in order but can be left blank (except for *oldlibrary*). A semicolon (;) after any field terminates the command; LIB assumes defaults for any remaining fields. The fields are described in “Specifying LIB Fields,” which begins on page 583.

To terminate the session at any time, press CTRL+C.

The following example instructs LIB to combine the object files FIRST.OBJ and SECOND.OBJ and to name the combined library THIRD.LIB:

```
LIB FIRST +SECOND, , THIRD
```

For a more detailed example of running LIB from the command line, see page 591.

## LIB Command Prompts

If you do not specify all expected input on the command line and do not end the line with a semicolon, LIB asks you for the missing input by displaying four prompts. LIB waits for you to respond to each prompt and then asks for the next input. The responses you give to the LIB command prompts correspond to the fields on the LIB command line. The following list shows these correspondences:

Library name: *oldlibrary* [*options*]  
Operations: *commands*  
List file: *listfile*  
Output library: *newlibrary*

You can select default responses to the remaining prompts at any time by typing a single semicolon (;) followed immediately by a carriage return. The defaults for prompts are the same as the defaults for the corresponding command-line fields.



The following example specifies `THIRD` as the output library-file name at the prompt:

```
Output library: THIRD
```

For a more detailed example of how to use the LIB prompts, see page 591.

## The LIB Response File

To run LIB without typing the full command line or responses to prompts, you can use a response file. You must first create a response file, which is a text file containing the command-line information; you can write and edit this file in PWB or use another editor. Then invoke LIB using the following command:

```
LIB @responsefile
```

The *responsefile* is the name of a text file containing some or all of the input expected by LIB. You can specify a full path with the filename. Precede it with an at sign (@).

You can also enter the name of the response file at any position in a command line or after any of LIB's prompts. The input from the response file is treated exactly as if it had been entered in the command line or after prompts. When you run LIB with a response file, LIB displays prompts followed by the input from the response file. If the response file does not contain all expected input and does not end with a semicolon, LIB prompts for the remaining responses.

Each input field in the response file must appear on a separate line or must be separated from other fields on the same line by a comma. A carriage return and linefeed combination is equivalent to pressing ENTER in response to a prompt or to entering a comma in a command line. Input must appear in the same order as in the command-line fields or at the LIB prompts.

The following response file tells LIB to add the object files `CURSOR.OBJ` and `HEAP.OBJ` as the last two modules in `LIBFOR.LIB`:

```
LIBFOR  
+CURSOR +HEAP;
```

## Specifying LIB Fields

For all three methods of input, LIB expects information to be specified in a definite order and organized into fields. This section describes the input fields in the order required by LIB. The fields are *oldlibrary*, *options*, *commands*, *listfile*, and *newlibrary*.

## The Library File

The *oldlibrary* field specifies the name of an existing library or a library to be created. If you omit the extension, LIB assumes an extension of .LIB. You can specify a full path with the filename.

---

**Important** The path and filename cannot contain a dash character (-). LIB interprets the dash as the LIB “delete” operator.

---

### Creating a Library File

To create a new library file, give the name of the library file you want to create in the *oldlibrary* field of the command line or at the `Library name:` prompt. LIB supplies the .LIB extension.

The name of the new library file must not be the name of an existing file. If it is, LIB assumes that you want to change the existing file. When you give the name of a library file that does not currently exist, LIB displays the following prompt:

```
Library file does not exist. Create?
```

Press `Y` to create the file or `N` to terminate the library session. If the library name is followed immediately by commands, a comma, or a semicolon, LIB suppresses the message and assumes `Y`.

### Performing Consistency Checks

If *oldlibrary* is followed immediately by a semicolon (;), LIB performs a consistency check on the specified library to see if all the modules in the library are in usable form. LIB prints a message only if it finds an invalid object module; no message appears if all modules are intact. LIB puts the message in the listing file if one is created; otherwise, it writes the message to the standard output.

The following example causes LIB to perform a consistency check of the library file FOR.LIB if the library file exists.

```
LIB FOR;
```

No other action is performed. LIB displays any consistency errors it finds and ends the session. If FOR.LIB does not exist, LIB creates an empty library file with that name.

## LIB Options

Options are not case sensitive and can appear only between the *oldlibrary* and *commands* fields on the command line or at the `Library Name:` prompt following the *oldlibrary* specification. The option name must be preceded by a forward slash

(/ ) as the option specifier. (Do not use a dash, -, as the option specifier. LIB interprets a dash as the “delete” operator.) Options can be abbreviated to the shortest unique name; the brackets show the optional part of the name. This chapter uses meaningful yet legal forms of the option names, which may be longer than the shortest unique names. LIB has the following options:

**/H[[ELP]]**

Calls the QuickHelp utility. If LIB cannot find the Help file or QuickHelp, it displays a brief summary of LIB command-line syntax.

**/I[[GNORECASE]]**

Tells LIB to ignore case when comparing symbols. LIB does this by default. Use the /NOI option to create a library that is marked as case sensitive.

Use /IGN when combining a case-sensitive library with others that are not case sensitive to create a new library that is not case sensitive. (See the /NOI option for more information.)

**/NOE[[XTDICTIONARY]]**

Prevents LIB from creating an extended dictionary of cross-references between modules. LINK uses the extended dictionary to speed up a library search. (LINK also has an option called /NOE, where /NOE means “do not read an extended dictionary.”)

Creating an extended dictionary requires more memory. If LIB reports the error message `no more virtual memory`, either use /NOE or build the library with fewer modules.

**/NOI[[GNORECASE]]**

Tells LIB to preserve case when comparing symbols. By default, LIB ignores case. Use /NOI when you have symbols that are the same except for case. (When LINK uses the library, it ignores case unless LINK’s /NOI option is specified.)

If a library is built with /NOI, the library is internally marked to indicate that case sensitivity is in effect. (Libraries for case-sensitive languages such as C are built with /NOI.) If you combine multiple libraries and any one of them is case sensitive, LIB marks the output library as case sensitive. To override this, use the /IGN option.

**/NOL[[OGO]]**

Suppresses the LIB copyright message.

**/P[[AGESIZE]]:*number***

Specifies the page size of a new library or changes the page size of an existing library. The *number* specifies the new page size in bytes. It must be an integer power of 2 between 16 and 32,768. The default page size is 16 bytes for a new library or the current page size for an existing library. Combined libraries take the largest component page size.

The page size of a library sets the alignment of modules stored in the library. Modules start at locations that are a multiple of the page size from the beginning of the file. When creating a library, LIB builds a dictionary, which holds the locations of each name in each module. Each location value represents the number of pages in the file. Because of this addressing method, a library with a large page size can hold more modules than a library with a smaller page size.

The page size also determines the maximum possible size of the .LIB file. This limit is  $number * 64K$ . For example, `/PAGE:32` limits the .LIB file to 2 megabytes ( $32 * 65,536$  bytes). However, for each module in the library, an average of  $number/2$  bytes of storage space is wasted. In most cases, a small page size is advantageous; you should use a small page size unless you need to put a very large number of modules in a library.

/?

Displays a brief summary of LIB command-line syntax.

## LIB Commands

The *commands* field specifies five operations for performing library-management tasks with LIB and manipulating modules: add, delete, replace, copy, and move. These commands can be used on the command line or in a response file in response to the `Operations:` prompt. To use this field, type a command operator followed immediately by a module name or an object-file name. You can specify more than one operation in this field in any order. If you leave the *commands* field blank, LIB does not make any changes to *oldlibrary*.

If you have many operations to perform during a library session, you can use an ampersand (&) to extend the operations line. Type the ampersand after a module name or filename; do not put the ampersand between an operator and a name. Immediately after the ampersand, press ENTER and then continue to type the rest of the command line. You can use this technique on the command line or in response to a prompt. When the ampersand is entered at a prompt, it tells LIB to repeat the `Operations:` prompt. In a response file, begin a new line of commands after the ampersand. See the examples at the end of this chapter for an illustration of the use of the ampersand.

You can perform one or more library-management functions during a LIB session. For each session, LIB determines whether a new library is being created or an existing library is being examined or modified. It then processes commands in the following order:

1. Deletion and move commands. LIB does not actually delete modules from the existing library file. Instead, it marks the selected modules for deletion, creates a new library file, and copies only the modules not marked for deletion into the new library file. If there are no deletion or move commands, LIB creates the new file by copying the original library file. (The *newlibrary* field, described on page 590, controls what happens to the existing library.)

2. Addition commands. Like deletions, additions are not performed on the original library file. Instead, the additional modules are appended to the end of the new library file.

As LIB carries out these commands, it reads the object modules in the library and checks them for validity. It then builds a dictionary, an extended dictionary (unless /NOE is specified), and a listing file (if a *listfile* is specified). The listing file contains a list of all public symbols and the names of the modules in which they are defined.

---

**Important** Paths and filenames specified with these commands cannot contain a dash character (-). LIB interprets the dash as the LIB “delete” operator.

---

## The Add Command (+)

Use the add command to create a library file, to add a module, or to combine libraries. The command has the form:

**+name**

where *name* is the name of the object file or library file. If no extension is specified, LIB assumes .OBJ. You can specify a path with the filename.

## Creating a New Library

Use the add command to create a new library from one or more object files. Specify the name of the new library in the *oldlibrary* field, then specify each object file’s name preceded by a plus sign. In the following example, LIB is instructed to create the library file FIRST.LIB containing the object module called MORE:

```
LIB FIRST +MORE;
```

## Adding Library Modules

Use the add command to add an object module to a library. Give the name of the object file to be added immediately following the plus sign. LIB adds object modules to the end of a library file.

LIB strips the drive, path, and extension from the object-file name and leaves only the base name. This becomes the name of the object module in the library. For example, if the object file B:\CURSOR.OBJ is added to a library file, the name of the corresponding object module is CURSOR.

In the following example, LIB is instructed to add the module MORE to the already existing library file FIRST.LIB:

```
LIB FIRST +MORE;
```

### Combining Libraries

To combine the contents of two libraries, supply the name of a library instead of an object file. In addition to standard libraries, LIB lets you combine import libraries (created by IMPLIB), 286 XENIX archives, and Intel-format libraries.

Specify the plus sign followed by the name of the library whose contents you wish to add to the original library. You must include the .LIB extension of the library name. Otherwise, LIB assumes that the file is an object file and looks for the file with an .OBJ extension.

LIB adds the modules of the new library to the end of the original library. Note that the added library still exists as an independent library. LIB copies the modules without deleting them.

Once you have added the contents of a library or libraries, you can save the new, combined library under a new name by giving a new name in the *newlibrary* field. If you omit this field, LIB saves the combined library under the name of the original library, that is, the name given in the *oldlibrary* field. The original library is saved with the same base name and the extension .BAK.

The following example combines DRAW.LIB and CHART.LIB into a library with the filename GRAPHICS.LIB:

```
LIB DRAW +CHART.LIB, ,GRAPHICS
```

### The Delete Command (-)

Use the delete command to delete an object module from a library. The command has the form:

*-name*

where *name* is the name of the module to be deleted. A module name does not have a path or extension; it is simply a name, such as CURSOR.

The following example tells LIB to delete the FLOAT module from the MATH.LIB library:

```
LIB MATH -FLOAT;
```

## The Replace Command (-+)

Use the replace command to replace a module in the library. The command has the form:

**-+name**

where *name* is the name of the module to be replaced. A module name has no path and no extension. LIB deletes the given module and then appends the object file having the same name as the module. The object file is assumed to have an .OBJ extension and to reside in the current directory.

The following three examples of command lines are equivalent. All three instruct LIB to replace the HEAP module in the library LANG.LIB. LIB deletes the HEAP module from the library and then appends the object file HEAP.OBJ as a new module in the library. Delete operations are always carried out before add operations, regardless of the order in which they are specified.

```
LIB LANG -+HEAP;  
LIB LANG -HEAP +HEAP;  
LIB LANG +HEAP -HEAP;
```

## The Copy Command (\*)

Use the copy command to copy a module from the library file into a newly created object file of the same name. The command has the following form:

**\*name**

where *name* is the name of the module to be copied. The module remains in the library file. LIB names the object file by using the base name of the module and adding an .OBJ extension. It then puts it in the current directory. You cannot override this filename or location; however, you can later rename the file and copy or move it to any location. LIB writes the full name of the object file (including drive, path to the current directory, base name, and extension) into the header of the object file.

## The Move Command (-\*)

Use the move command to move an object module from the library file to an object file. The command has the form:

**-\*name**

where *name* is the name of the module to be moved. This operation is equivalent to copying the module to an object file using the copy command (\*) and then deleting the module from the library using the delete command (-).

## The Cross-reference Listing

A cross-reference listing contains two lists in the following order:

1. An alphabetical list of all public symbols in the library. Each symbol name is followed by the name of the module in which it is defined.
2. A list of the modules in the library with the location and size of each. Under each module name is an alphabetical listing of the public symbols defined in that module.

Create a cross-reference listing by giving a name for the listing file in the *listfile* field of the command line or at the `List file:` prompt. To create it in a directory other than the current one, specify a full path for the listing file. LIB does not supply a default extension if you omit the extension. When you do not specify a filename, the default is the special file named NUL, which tells LIB not to create a listing.

The following example creates a listing called LCROSS.PUB. It does nothing else except perform a consistency check of the library file LANG.LIB.

```
LIB LANG, LCROSS.PUB;
```

---

**Note** Source code symbols less than 127 characters long can exceed 127 characters as an internal or decorated name in an object file. LIB may not be able to successfully build a library from an object file if it contains symbols with names longer than 127 characters.

---

## The Output Library

The *newlibrary* field specifies a name for a changed library file. You can specify a full path with the filename. LIB does not supply a default extension if you omit the extension.

You can change an existing library file by giving the name of the library file at the `Library name:` prompt. All operations you specify in the *commands* field of the command line or at the `Operations:` prompt are performed on that library.

LIB keeps both the unchanged library file and the newly changed version; it copies the library and makes changes to the copy. (This prevents the loss of your original file if you terminate LIB before the session is finished.) It names the two versions as follows:

- ◆ If you specify the name of a new library file in the *newlibrary* field, the modified library is stored under that name, and the original library is preserved under its own name.



- ◆ If you leave the field blank, LIB replaces the original library file with the changed version of the library and saves the original library file with the extension .BAK. Either way, at the end of a session you have two library files: the changed version and the original version.

---

**Note** You need enough space on disk for both the original library file and the copy.

---

## Examples

All the following examples instruct LIB to:

- ◆ Suppress the creation of an extended dictionary of cross-references.
- ◆ Move the module STUFF from the library FIRST.LIB to an object file called STUFF.OBJ; the module STUFF is deleted from the library.
- ◆ Copy the module MORE from the library to an object file called MORE.OBJ; the module MORE remains in the library.
- ◆ Delete the module HEAP from the library.
- ◆ Create a cross-listing file called CROSSLST.
- ◆ Name the revised library SECOND.LIB. The new library contains all the modules in FIRST.LIB except STUFF and HEAP.
- ◆ Leave the original library, FIRST.LIB, unchanged.

### Command-Line Example

```
LIB FIRST /NOE -*STUFF *MORE &  
-HEAP, CROSSLST, SECOND
```

### LIB Prompt Example

```
Library Name: FIRST /NOE  
Operations: -*STUFF *MORE &  
Operations: -HEAP  
List File: CROSSLST  
Output file: SECOND
```

### Response-File Example

```
FIRST /NOE
-* STUFF *MORE &
-HEAP
CROSSLST
SECOND
```

## LIB Exit Codes

LIB returns an exit code (also called return code or error code) to the operating system or the calling program. You can use the exit code to control the operation of batch files or makefiles.

Code	Meaning
0	No error.
2	Program error. Commands or files given as input to the utility produced the error.
4	System error. The library manager encountered one of the following problems: <ul style="list-style-type: none"><li>◆ There was insufficient memory.</li><li>◆ An internal error occurred.</li><li>◆ The user interrupted the session.</li></ul>

## Creating Help Files With HELPMAKE

This chapter describes how to create and modify Help files using the Microsoft Help File Maintenance Utility (HELMAKE) version 1.08. A “Help file” is a file that can be read by the Microsoft Advisor Help system and QuickHelp. If you’ve used the Programmer’s WorkBench (PWB) or one of the Microsoft Quick languages, you already know the advantages of the Microsoft Advisor. HELPMAKE extends these advantages by allowing you to customize the Microsoft Help files or create your own Help files.

HELMAKE translates Help source files to a Help database accessible within the following environments:

- ◆ Microsoft Programmer’s WorkBench (PWB)
- ◆ Microsoft QuickHelp utility
- ◆ Microsoft CodeView debugger
- ◆ Microsoft Editor version 1.02
- ◆ Microsoft QuickC compiler versions 2.0 and later
- ◆ Microsoft QuickBasic versions 4.5 and later
- ◆ Microsoft QuickPascal version 1.0
- ◆ Microsoft Word version 5.5
- ◆ MS-DOS EDIT version 5.0
- ◆ MS-DOS QBasic version 5.0

---

**Warning** The PWB editor breaks lines longer than about 250 characters. Some Help sources contain lines longer than this. To edit files that have long lines, you must either use an editor (such as Microsoft Word) that does not restrict line length or extend long lines using the backslash ( \ ) line-continuation character.

---

## Overview

HELPMAKE creates a Help file by encoding a source file. A Help file contains information that can be read by a Help reader (sometimes referred to in this chapter as an application). Examples of Help readers are the Microsoft Advisor or Microsoft QuickHelp. Help files have an .HLP extension.

Source files for HELPMAKE are text files that contain topic text along with attributes and commands that tell HELPMAKE how to process the file. HELPMAKE encodes text files written in the following formats: QuickHelp, rich text format (RTF), and minimally formatted ASCII.

Encoding compresses the text and translates the commands into information for the Help reader. You can control the amount of compression and other aspects of encoding.

HELPMAKE can also decode an existing Help file. Decoding decompresses the text into ASCII format. Attributes and commands can be preserved or omitted during decoding. You can modify an existing Help file by using HELPMAKE to decode the file and then rebuild it into a different Help file. You can even modify a Microsoft help file by decompressing it and then encoding it with your changes. Regardless of the source format, HELPMAKE always decodes a Help file into the QuickHelp format.

The basic unit of Help is the database. A Help database is an individual file created by HELPMAKE. At the time it is created, it is given an internal name that is the same as the filename on disk. If the file is later renamed, the database retains this internal name as it is known by HELPMAKE and the Help reader.

A Help system consists of one or more physical Help files that are available to a Help reader. A physical Help file is a file on disk with an .HLP extension. It can contain a single database (with either the same or a different filename) or multiple databases. To create a physical Help file that contains several Help databases, use the MS-DOS COPY command. Specify the /b modifier to combine them as binary files. You can merge several databases into one physical Help file, combine two or more physical Help files, or append a Help database to an existing physical Help file. For example, the following command concatenates three individual Help databases into a new physical Help file:

```
COPY help1.hlp /b + help2.hlp /b + help3.hlp /b myhelp.hlp
```

The next example merges the database `yourhelp.hlp` with the existing Help file `utils.hlp`:

```
COPY utils.hlp /b + yourhelp.hlp /b
```

It is recommended that you back up existing Help files before running the COPY command. You may need to concatenate Help files if you reach a limit on physical files imposed by your system or the Help reader.

You can use HELPMAKE to deconcatenate, or split, a physical Help file that contains multiple databases. If you want to decompress such a Help file, you must first split it and then decompress each database.

When designing a Help system, it is important to know that a single database is more efficient to search than multiple databases or physical Help files.

## Running HELPMAKE

The following sections describe HELPMAKE's syntax and options for encoding a Help file, decoding or deconcatenating a Help file, and getting Help on HELPMAKE. Some options apply only to encoding, others apply only to decoding, and a few apply to both.

The following are some general rules for syntax:

- ◆ Options are not case sensitive. Precede each option with either a forward slash (/) or a dash (-).
- ◆ You can specify a path with a filename. Separate multiple filenames with spaces or tabs. Where multiple files can be specified, you can use wildcard characters (\* and ?).

## Encoding

To create a Help file, use the following syntax:

`HELMAKE /E[[n]] /Ooutfile options sourcefiles`

The /E option encodes a Help source file and creates a compressed Help database. The *n* is a decimal number that specifies the type of compression. If *n* is omitted, HELPMAKE compresses the file as much as possible (about 50 percent). The value of *n* is in a range from 0 through 15, which represents the following compression techniques:

Value	Technique
0	No compression
1	Run-length compression
2	Keyword compression
4	Extended keyword compression
8	Huffman compression

You can add these values to combine compression techniques. For example, specify /E3 to get run-length and keyword compression. Use /E0 to create the database quickly during the testing stages of database creation when you are not yet concerned with size.

The /O option specifies a filename for the database. This option is required when encoding.

Additional options are discussed in the next section and in “Other Options” on page 599.

The *sourcefiles* field specifies one or more text files that contain Help source information.

## Options for Encoding

The following options control encoding:

### /Ac

Specifies *c* as a control character for the Help database. A control character marks a line that contains special information for internal use by the Help reader. Control characters differ for each Help reader. For example, the Microsoft Advisor uses a colon (:) to indicate a command, so you must specify /A: when building a Help file for use with the Advisor. HELPMMAKE assumes /A: if the /T option is specified.

### /C

Makes context strings case sensitive.

### /K*filename*

Optimizes keyword compression by supplying a list of characters to act as word separators. The *filename* is a text file that contains a list of separator characters. HELPMMAKE can apply “keyword compression” to words that occur often enough to justify replacing them with shorter character sequences. A “word” is any series of characters that do not appear in the separator list. The default separator list includes all ASCII characters from 0 to 32, ASCII character 127, and the following characters:

```
! " # & ' ( ) * + - , / : ; < = > ? @ [ \ ] ^ _ { | } ~
```

You can improve keyword compression by designing a separator list tailored to a specific Help file. For example, a number sign (#) is treated as a separator by default. However, in a Help file about the C language, you might want to have HELPMMAKE treat each directive such as **#include** as a keyword instead of as a separator followed by a word. To encode **#include** and other directives as keywords, create a separator list that omits the number sign:

```
! " & ' ( ) * + - , / : ; < = > ? @ [ \ ] ^ _ { | } ~
```

ASCII characters in the range from 0 through 31 are always separators, so you do not need to list them. However, a customized list must include all other separators, including the space (ASCII character 32). If you omit the space, HELPMAKE will not use spaces as word separators.

**/L**

Locks the Help file so that it cannot be decoded later.

**/Sn**

Specifies the type of input file, according to the following *n* values:

Option	File Type
/S1	Rich text format (RTF)
/S2	QuickHelp (the default)
/S3	Minimally formatted ASCII

**/T**

Translates dot commands into internal format. If your source file contains dot commands other than **.context** and **.comment**, you must supply this option. The **/T** option is required if you want to use commands in the QuickHelp dot format. Dot commands are described on page 605. HELPMAKE assumes the **/A:** option if **/T** is specified.

**/Wwidth**

Sets the fixed width of the resulting Help text in number of characters. The *width* is a decimal number in a range from 11 through 255. If **/W** is omitted, the default width is 76. When encoding an RTF source (**/S1**), HELPMAKE wraps the text to *width* characters. When encoding QuickHelp (**/S2**) or minimally formatted ASCII (**/S3**) files, HELPMAKE truncates lines to this width.

### Example

The following example invokes HELPMAKE with the **/V**, **/E**, and **/O** options:

```
HELMAKE /E /V /Omy.hlp my.txt > my.log
```

HELMAKE reads input from the source file `my.txt` and creates the compressed Help database `my.hlp` (**/O** option). The **/E** option, without a compression specification, maximizes compression. The **/V** option enables verbose output; the MS-DOS redirection symbol (**>**) sends a log of HELPMAKE diagnostic information to the file `my.log`, because the verbose mode can generate a lengthy log.

## Decoding

To decode a Help file, use the following syntax:

```
HELMAKE /D[[c]] [[/Ooutfile]] options sourcefiles
```

The `/D` option decodes a Help file or splits a concatenated file into its component databases. The `/D` option can take a qualifying character *c*, which is either S or U.

Specify `/D` without a qualifying character to fully decode a database into a text file that is in QuickHelp format, with all links and formatting information intact. If the physical Help file contains concatenated databases, only the first database is decoded.

Specify `/DU` to decompress the database and remove all screen formatting and links. If the physical Help file contains concatenated databases, only the first database is decoded.

Specify `/DS` to split (deconcatenate) a physical Help file that contains one or more databases. HELPMAKE creates a physical Help file for each database in the original Help file. The Help file is not decompressed. HELPMAKE names the deconcatenated files using the names of the databases. The deconcatenated files are placed in the current directory. If a database in the file has a name that matches the name of the original physical Help file, HELPMAKE issues an error. In this case, rename the physical Help file, or run HELPMAKE in another directory and specify a path with the source file. Do not use the `/O` option with `/DS`.

The `/O` option specifies a filename for the decoded file. If `/O` is not specified, HELPMAKE sends the text to standard output. This option is not valid when using `/DS`.

There is one option available to control decoding. The `/T` option translates commands from internal format to dot-command format. This option applies only when using `/D`. It is recommended to always use this option to make the resulting source file more readable.

Additional options are discussed in “Other Options” on page 599.

The *sourcefiles* field specifies one or more physical Help files.

### Example

The following example decodes the help file `my.hlp` into the source file `my.src`:

```
HELPMAKE /D /T /Omy.src my.hlp
```

## Getting Help

To get help on HELPMAKE, use the following syntax:

```
HELPMAKE {/H[[ELP]] |/?}
```

The following are the options for help:



/?

Displays a brief summary of the HELPMAKE command-line syntax and exits without encoding or decoding any files. All other information on the command line is ignored.

/H[[ELP]]

Calls the QuickHelp utility and displays Help about HELPMAKE. If HELPMAKE cannot find QuickHelp or the Help file, it displays the same information as with the /? option. No files are encoded or decoded. All other information on the command line is ignored.

## Other Options

The following options apply whether encoding or decoding.

### The /NOLOGO option

The /NOLOGO option suppresses the HELPMAKE copyright message.

### The /V option

The /V option controls the verbosity of diagnostic and informational output. HELPMAKE sends this information to standard output. The syntax for /V is:

/V[[*n*]]

Specify /V without *n* to get a full output. The decimal number *n* controls the amount of information produced. Numbers in a range from 0 through 3 are valid only for decoding. The values of *n* are:

Option	Output
/V	Maximum diagnostic output
/V0	No diagnostic output and no banner
/V1	HELMMAKE banner only
/V2	Pass names
/V3	Context strings encountered on first pass
/V4	Context strings encountered on each pass
/V5	Any intermediate steps within each pass
/V6	Statistics on Help file and compression

## Source File Formats

You can create Help source files for HELPMAKE in any of three formats. The QuickHelp format is the default format for encoding. When Help databases are decoded, the resulting text files are always in QuickHelp format. The discussion

that follows uses QuickHelp format to describe how to create a Help source file. Later sections describe the two other formats: rich text format (RTF) and minimally formatted ASCII.

Rich text format is a Microsoft word-processing format that is supported by several word processors, including Microsoft Word version 5.0 and later and Microsoft Word for Windows. For more information, see “Rich Text Format” on page 609.

Minimally formatted ASCII files define contexts and their topic text. They cannot contain formatting commands or explicit links. For more information, see “Minimally Formatted ASCII” on page 612.

In addition to these three formats, you can link to unformatted ASCII files from within a Help database. Unformatted ASCII files are text files with no formatting commands, context definitions, or special information. You do not process unformatted ASCII files with HELPMMAKE. An unformatted ASCII file does not become a database or part of a physical Help file. The file’s name is used as the object of a link. For example, you can create a link to an include file or a program example. Any word that is an implicit link in other Help files is also an implicit link in unformatted ASCII files.

A Help system can use any combination of files with different format types.

## Elements of a Help Source File

The following sections describe how to create the fundamental elements of a Help file.

### Defining a Topic

A Help source file is a text file that consists of a sequence of topics. A topic is the fundamental unit of Help information. It is usually a screen of information about a particular subject.

Each topic begins with one or more consecutive **.context** statements or definitions. The topic consists of all subsequent lines up to the next **.context** statement. A context definition associates the topic with a “context string,” which is the word or phrase for which you want to be able to request Help. When Help is requested on a context string, the Help reader displays the topic. A context definition has the following form:

```
.context string
```

The **.context** command defines a context string for the topic that follows it. A context string can contain one word or several words depending on the Help reader and the delimiters it understands. For example, because Microsoft QuickBasic

considers spaces to be delimiters, a context string in a QuickBasic Help file is limited to a single word. Other applications, such as PWB, can handle context strings that span several words. In either case, the application hands the context string to an internal “Help engine” that searches the database for a topic that is marked with the requested context string.

For example, the following line introduces Help for the **#include** directive:

```
.context #include
```

A topic can be associated with more than one context string. For example, the C-language functions **strtod**, **strtol**, **\_strtold**, and **strtoul** are described in a single topic, and each is defined in a separate **.context** command for that topic, as follows:

```
.context strtod  
.context _strtold  
.context strtol  
.context strtoul
```

---

**Warning** HELPMAKE warns you if it encounters a duplicate context definition within a given Help source file. Each context string must be unique within a database. You cannot associate a single context string with several topics in a single database.

---

A context string can be global or local. The *string* for a local context is preceded by an at sign (@). For more information, see “Local Contexts” on page 603.

## Creating Links to Other Topics

A topic can contain a link to another topic. Links let you navigate a Help database. When a topic is displayed, you can ask for Help on links contained in the topic. These links can be associated with other contexts in the same Help database, contexts in other Help databases, or even ASCII files on disk. You can view the cross-referenced material immediately by activating the link without having to search the Help system’s indexes and tables of contents for the topic.

The keystroke that activates a link depends on the application. Consult the documentation for each product for the various ways to get Help on a link. In Microsoft language products, use ENTER, SPACEBAR, or F1. If the file that contains the link’s destination is not already open, the Help reader finds it and opens it.

The topic text can present the link in various ways, depending on how you want to design your Help system. The link can appear as a “See:” cross-reference, for example, or as a button that contains a title surrounded by special characters. It can even be undistinguished from surrounding text.

A link is either explicit (coded) or implicit (available without coding). It is associated with either a global context (visible throughout the Help system) or a local context (visible only in one database). The following sections discuss these features of links.

## Explicit Links

An explicit link is a word or phrase coded with invisible text that provides the context to which the link refers or the action which the Help reader is to take. Use the `\v` formatting attribute to delimit the invisible text. Format the explicit link in the source file using the following syntax:

*string\vtext\v*

If *string* consists of more than one word, you must anchor the string with the `\a` formatting attribute as follows:

*\astring\vtext\v*

An anchored link must be specified entirely on one line.

The `\v` attributes surround the invisible *text*, which is one of the following commands to the Help reader:

*contextstring*

Display the topic associated with *contextstring* when the link is activated. The context string must be available either as a local context in the same Help database or as a global context anywhere in the Help system. For a discussion of global and local contexts, see “Local Contexts” on page 603.

*helpfile!contextstring*

Search *helpfile* for *contextstring* and display the topic associated with it. Only the specified Help database or physical Help file is searched for the context. Since *helpfile* is not in the local database, *contextstring* must be a global context. Use this specification to confine the search to a single database if a context is contained in more than one database and you want only one of the topics to be found.

*filename!*

Display *filename* as a single topic. The specified file must be a text file no larger than 64K.

*!command*

Execute the command specified after the exclamation point (!). The command is case sensitive. Commands are application-specific. For example, in the Microsoft Advisor and QuickHelp, the command `!B` represents the previously accessed topic.

In the following example, the word `Example` is an explicit link:

```
\bSee also:\p Example\vopen.ex\v
```

The `\v` formatting attribute marks the explicit link in the Help text. The `\b` and `\p` are formatting attributes that mark `See also:` as bold text. (Formatting attributes are described on page 605.) The link refers to `open.ex`. On the screen, this line appears as follows:

```
See also: Example
```

If you select any letter in `Example` and request Help, the Help reader displays the topic whose context is `open.ex`.

To create an explicit link that contains more than one word, you must use an anchor, as in the following example:

```
\bSee also:\p \aExample 1\vopen.ex1\v, \aExample 2\vopen.ex2\v
```

The `\a` attribute creates an anchor for the explicit link. The phrase following the `\a` attribute refers to the context specified in the invisible text. The first `\v` attribute marks both the end of the anchored string and the beginning of the invisible text. The second `\v` attribute ends the invisible text. The anchored link must fit on one line.

## Implicit Links

An implicit link is a single word for which a global context exists somewhere in the Help system. Any word that appears as a global context is implicitly linked. You do not code the word to create the link. When you ask for Help on a word that exists as an implicit link, the Help reader displays the topic that has a **.context** string that matches the selected word.

For example, suppose that the Help database contains a screen that starts with:

```
.context open
```

If you ask for Help on the word “open” (using the features for requesting Help that are available in your Help reader), the topic that begins with `.context open` is displayed. An explicit link to the topic is not necessary. For example, in PWB you can place the cursor on the word “open” as it appears in your source file or in a displayed Help topic, then click the right mouse button or press F1. Thus, every occurrence of “open” is a potential implicit link.

## Local Contexts

A “local context” is a context string that begins with an at sign (`@`). Local contexts use less file space and speed access. However, a local context has meaning only within the database in which it appears.

HELPMAKE encodes a local context as an internally generated number rather than a context string. This saves space in the database. Unlike a global context (a context string that is specified without the preceding @), a local context is not stored as a string. Thus, topics headed by local contexts can only be accessed using explicit links and cannot be accessed from another database. Local contexts are not restored as strings when a database is decompressed.

The following source file contains two topics, one marked with a global context and one marked with a local context:

```
.context Global
    This is a topic that is marked with a global context.
    It is accessed using the context string "Global". It
    contains a link to a topic marked with a local context.
    See: \aA Local Topic\v@Local\v
.context @Local
    This topic can be reached only by the explicit link in
    the previous topic (or by sequentially browsing the file).
```

The text A Local Topic is explicitly linked to @local, which is a local context. If the user asks for Help on the text or scrolls through the Help file, the Help reader displays the topic text that follows the context definition for @local. This topic cannot be accessed any other way (except by sequentially browsing the database).

If you want a topic to be accessible in both local and global contexts, mark the topic text with both global and local **.context** statements:

```
.context Global
.context @Local
    This is a topic that is marked with a global context and
    a local context. It can be accessed using the context
    string "Global" (as an explicit or implicit link) or the
    context string "@Local" (as an explicit link only). (It
    can also be reached by sequentially browsing the file).
```

Both **.context** statements must appear together, immediately before the topic text they are to be associated with.

To create a context that begins with a literal @, precede it with a backslash (\).

## Formatting Topic Text

You can use formatting attributes to control the appearance of the text on the screen. Using these attributes, you can make words appear in various colors, inverse video, and so forth, depending on the application and the capabilities of your display. This is useful, for example, to distinguish explicit links in the text.

Each formatting attribute consists of a backslash (\) followed by a character. Table 18.1 lists the formatting attributes.

**Table 18.1 Formatting Attributes**

Formatting Attribute	Action
\a	Anchors text for explicit links
\b, \B	Turns bold on or off
\i, \I	Turns italics on or off
\p, \P	Turns off all attributes
\u, \U	Turns underlining on or off
\v, \V	Turns invisibility on or off (hides explicit links)
\\	Inserts a single backslash in text

On color monitors, text labeled with the bold, italic, and underline attributes is translated by the application into suitable colors, depending on the user's default color selections. On monochrome monitors, the text's appearance depends on the application.

The \b, \i, \u, and \v options are toggles; they turn their respective attributes on or off. You can use several of these on the same text. Use the \p attribute to turn off all attributes except \v. Use the \v attribute to hide explicit links in the text. Explicit links are discussed on page 602.

Only visible characters count toward the character-width limit specified with the /W command-line option. Lines that begin with an application-specific control character are truncated to 255 characters regardless of the width specification. For more information on truncation and application-specific control characters, see "Options for Encoding" on page 596.

In the following example, \b initiates bold text for Example 1, and \p changes the remaining text to plain text:

```
\bExample 1\p This is a bold head for the first example.
```

## Dot and Colon Commands

Dot commands identify topics and convey other topic-related information to the Help reader.

The most important dot command is the **.context** command, described in "Defining a Topic" on page 600. Every topic begins with one or more **.context** commands. Each **.context** command defines a context string for the topic. You can define more than one context for a single topic, as long as you do not place any topic text between the context definitions.

Most dot commands have an equivalent colon command, which consists of a colon (: ) followed by a character. If you decode a database without using /T, commands

in the database are shown as colon commands. You can use both colon commands and dot commands in the same source file. If you use any dot commands other than **.context** or **.comment**, you must supply the /T option when encoding.

Table 18.2 lists the dot and colon commands. Some commands are not supported by all Help readers.

**Table 18.2 Dot and Colon Commands**

Dot Command	Colon Command	Action
<b>.category</b> <i>string</i>	:c	Lists the category in which the current topic appears and its position in the list of topics. The category name is used by the QuickHelp Categories command, which displays the list of topics. Supported only by QuickHelp.
<b>.command</b>	:x	Indicates that the topic cannot be displayed. Use this command to hide command topics and other internal information.
<b>.comment</b> <i>string</i> <b>..</b> <i>string</i>	none	The <i>string</i> is a comment that appears only in the source file. Comments are not inserted in the database and are not restored during decoding.
<b>.context</b> <i>string</i>	none	The <i>string</i> defines a context.
<b>.end</b>	:e	Ends a paste section. See the <b>.paste</b> command. Supported only by QuickHelp.
<b>.execute</b>	:y	Executes the specified command. For example, <b>.execute Pmark context</b> represents a jump to the specified context at the specified mark. See the <b>.mark</b> command.
<b>.freeze</b> <i>numlines</i>	:z	Locks the first <i>numlines</i> lines at the top of the screen. These lines do not move when the text is scrolled.
<b>.length</b> <i>topiclength</i>	:l	Sets the default window size for the topic in <i>topiclength</i> lines.
<b>.line</b> <i>number</i>	none	Tells HELPMMAKE to reset the line number to begin at <i>number</i> for subsequent lines of the input file. Line numbers appear in HELPMMAKE error messages. See <b>.source</b> . The <b>.line</b> command is not inserted in the Help database and is not restored during decoding.



Table 18.2 Dot and Colon Commands (*continued*)

Dot Command	Colon Command	Action
<b>.list</b>	:i	Indicates that the current topic contains a list of topics. Help displays a highlighted line; you can choose a topic by moving the highlighted line over the desired topic and pressing ENTER. If the line contains a coded link, Help looks up that link. If it does not contain a link, Help looks within the line for a string terminated by two spaces or a newline character and looks up that string. Otherwise, Help looks up the first word.
<b>.mark</b> <i>name</i> [[ <i>column</i> ]]	:m	Defines a mark immediately preceding the following line of text. The marked line shows a script command where the display of a topic begins. The <i>name</i> identifies the mark. The <i>column</i> is an integer value specifying a column location within the marked line. Supported only by QuickHelp.
<b>.next</b> <i>context</i>	:>	Tells the Help reader to look up the next topic using <i>context</i> instead of the topic that physically follows it in the file. You can use this command to skip large blocks of <b>.command</b> or <b>.popup</b> topics.
<b>.paste</b> <i>pastename</i>	:p	Begins a paste section. The <i>pastename</i> appears in the QuickHelp Paste menu. Supported only by QuickHelp.
<b>.popup</b>	:g	Tells the Help reader to display the current topic as a popup window instead of as a normal, scrollable topic. Supported only by QuickHelp.
<b>.previous</b> <i>context</i>	:<	Tells the Help reader to look up the previous topic using <i>context</i> instead of the topic that physically precedes it in the file. You can use this command to skip large blocks of <b>.command</b> or <b>.popup</b> topics.
<b>.raw</b>	:u	Turns off special processing of certain characters by the Help reader.
<b>.ref</b> <i>topic</i> [[, <i>topic</i> ]]	:r	Tells the Help reader to display the <i>topic</i> in the Reference menu. You can list multiple topics; separate each additional <i>topic</i> with a comma. A <b>.ref</b> command is not affected by the /W option. If no <i>topic</i> is specified, QuickHelp searches the line immediately following for a See or See Also reference; if present, the reference must be the first word on the line. Supported only by QuickHelp.

**Table 18.2** Dot and Colon Commands (*continued*)

Dot Command	Colon Command	Action
<code>.source filename</code>	(none)	Tells HELPMAKE that subsequent topics come from <i>filename</i> . HELPMAKE error messages contain the name and line number of the input file. The <code>.source</code> command tells HELPMAKE to use <i>filename</i> in the message instead of the name of the input file and to reset the line number to 1. This is useful when you concatenate several sources to form the input file. See <code>.line</code> . The <code>.source</code> command is not inserted in the Help database and is not restored during decoding.
<code>.topic text</code>	<code>:n</code>	Defines <i>text</i> as the name or title to be displayed in place of the context string if the application Help displays a title. This command is always the first line in the context unless you also use the <code>.length</code> or <code>.freeze</code> commands.

## Example

The following example is in QuickHelp format:

```
.context Sample
.context @Sample
.topic Sample Help Topic
.length 20
.freeze 3

                                \i\p\aBack\v!B\v\i\p
-----

Help can contain text with three attributes:

\bAttribute\p      \bQuickHelp Code\p

\iItalic\p        \i
\bBold\p          \b
\uUnderline\p     \u

The visual appearance of each attribute
or combination of attributes is determined
by the application that displays the help.

\bSee:\p
```

```
Coding, Expressions, Grammar, Keywords, Syntax
\i\p\Flow Control\@flow\!v\i\p
\i\p\Release Notes\!v$DOC:README.DOC!\v\i\p
.context @flow
.topic Sample Help: Flow Control
.length 8
.freeze 3

                                   \i\p\Back\!v!B\!v\i\p
-----
```

Here's another sample help screen.

```
This is an explicit link: \i\p\Sample\@Sample\!v\i\p
This is an implicit link: Sample
```

## Other Help Text Formats

There are two other Help text formats you can use to create a Help database: rich text format (RTF) and minimally formatted ASCII. These formats are described in the next two sections.

### Rich Text Format

Rich text format (RTF) is a Microsoft word-processing format supported by several word processors, including Microsoft Word version 5.0 and later and Microsoft Word for Windows. RTF is an intermediate format that allows documents to be transferred between applications without loss of formatting. You can use RTF to simplify the transfer of help files from one format to another. Like QuickHelp files, RTF files can contain formatting attributes and links.

As with the other text formats, each topic in an RTF source file consists of one or more context strings followed by topic text. The help delimiter (>>) at the beginning of any paragraph marks the beginning of a new Help entry. The text that follows on the same line is defined as a context for the topic. If the next paragraph also begins with the Help delimiter, it also defines a context string for the same topic. You can define any number of contexts for one topic. The topic text comprises all subsequent paragraphs up to the next paragraph that begins with the Help delimiter.

All QuickHelp dot commands, except **.context** and **.length**, can be used in RTF files. Each command must appear in a separate paragraph.

There are two ways to create an RTF file. The easiest way is to use a RTF word processor. RTF files usually contain additional information that is not visible to the user; HELPMAKE ignores this extra information.

You can also use an ordinary text editor to insert RTF codes manually. Utility programs exist that convert text files in other formats to RTF format. For more information on converting to and from RTF, see the Microsoft Word for Windows *User's Guide*.

## Using a Word Processor

In an RTF-compatible word processor, enter the text and format it as you want it to appear: bold, underlined, hidden, and italic. You can also format paragraphs by selecting body and first-line indenting. Choose a monospace font and set the margin to the /W value you plan to encode the database with. The only item you need to insert into an RTF file manually is the Help delimiter (>>) followed by the context string that starts each entry. If you use dot commands, place each in its own paragraph.

When you have entered and formatted the text, save it in RTF format. In Microsoft Word version 5.5, for example, choose Save As from the File menu, then select RTF under Format.

You cannot see the RTF formatting codes when you load an RTF file into a compatible word processor. The word processor displays the text with the specified attributes. However, you can view these codes by loading an RTF file into a text editor or word processor.

## Manually Inserting RTF Formatting Codes

RTF uses curly braces ( { } ) for nesting. Thus, the entire file is enclosed in curly braces, as is each specially formatted text item.

When you manually insert RTF codes, you must delimit each dot command with the \par code. (An RTF editor or word processor inserts “\par” at the beginning and end of a paragraph.) For example, to use the **.popup** command, write:

```
\par .popup\par
```

HELPMAKE recognizes the subset of RTF codes listed in Table 18.3.

**Table 18.3 RTF Formatting Codes**

RTF code	Action
\b	Bold. The Help reader decides how to display this; often it is intensified text.
\fin	Paragraph first-line indent, <i>n</i> twips.*
\i	Italic. The application decides how to display this; often it is reverse video.
\lin	Paragraph indent from left margin, <i>n</i> twips.*
\line	New line (not new paragraph).
\par	End of paragraph.

**Table 18.3 RTF Formatting Codes** (*continued*)

RTF code	Action
<code>\pard</code>	Default paragraph formatting.
<code>\plain</code>	Default attributes. On most screens, this is nonblinking normal intensity.
<code>\tab</code>	Tab character.
<code>\ul</code>	Underline. The application decides how to display this attribute; some adapters that do not support underlining display it as blue text.
<code>\v</code>	Hidden text. Hidden text is used for explicit links; it is not displayed.

\* A “twip” is 1/20 of a point or 1/1440 of an inch. One space is approximately 180 twips.

## Encoding RTF with HELPMMAKE

When HELPMMAKE compresses an RTF file, it formats the text to the width given by the `/W` option and ignores the paragraph formats.

When HELPMMAKE encodes RTF, any text between an RTF code and invisible text becomes an explicit link. This is illustrated in the following example:

```
{\b Formatting table}{\v printf.ex}
```

The string `Formatting table` is displayed in bold and is part of an explicit link to `printf.ex`.

## Example

The following example is in RTF format:

```
{\rtf1
\pard\plain >>Sample
\par >@Sample
\par .topic Sample Help Topic
\par .freeze 3
\par \pard \li8000 {\i }{\b Back}{\v !B}{\i }
\par \pard -----
\par
\par \pard \li360 Help can contain text with three attributes:
\par \pard
\par \pard \li360 {\b Attribute}      {\b QuickHelp Code}
\par \pard
\par \pard \li360 {\i Italic}        \i
\par \pard \li360 {\b Bold}         \b
\par \pard \li360 {\ul Underline}   \u
\par \pard
\par \pard \li360\ri720 The visual appearance of each attribute
or combination of attributes is determined
by the application that displays the help.
```

```
\par \pard
\par \pard \li360 {\b See:}
\par \pard
\par \pard \li360 Coding, Expressions, Grammar, Keywords, Syntax
\par \pard \li360 {\i }{\b Flow Control}{\v @flow}{\i }
\par {\i }{\b Release Notes}{\v $DOC:README.DOC!}{\i }
\par \pard >@flow
\par .topic Sample Help: Flow Control
\par .freeze 3
\par \pard \li8000 {\i }{\b Back}{\v !B}{\i }
\par \pard -----
\par
\par \pard \li360 Here's another sample help screen.
\par
\par \pard \li360 This is an explicit link: {\i }{\b Sample}{\v
@Sample}{\i }
\par \pard \li360 This is an implicit link: Sample
\par
}
```

## Minimally Formatted ASCII

Minimally formatted ASCII files define contexts and their topic text. The Help information is displayed exactly as it appears in the file. A minimally formatted ASCII file cannot contain screen-formatting commands or explicit links. Any formatting codes are treated as ASCII text. Minimally formatted ASCII files have a fixed width.

A minimally formatted ASCII file contains a sequence of topics, each preceded by one or more context definitions. Each context definition must be on a separate line that begins with a help delimiter (>>). The topic consists of all subsequent lines up to the next context definition.

Implicit links work the same way they do in the other formats. A word in the Help text is an implicit link if it exists as a context somewhere in the Help system.

There are two ways to use a minimally formatted ASCII file. You can compress it with HELPMAKE and create a Help database, or a Help reader can access the uncompressed file directly. A Help reader can search a minimally formatted ASCII file faster if it has been compressed.

The following example coded in minimally formatted ASCII shows the same sample help topic as the QuickHelp and RTF examples presented elsewhere in this chapter:

```

>>Sample
-----[ Sample Help Topic ]-----
  Help can contain text with three attributes:

  Attribute      QuickHelp Code
  Italic         \i
  Bold           \b
  Underline      \u

  The visual appearance of each attribute
  or combination of attributes is determined
  by the application that displays the help.

  See:

  Coding, Expressions, Grammar, Keywords, Syntax

>>Coding
-----[ Sample Help: Coding ]-----

  Here's another sample help screen.

```

The last three lines of this example differ from the ending lines in the other two examples because minimally formatted ASCII files cannot contain explicit links, and the help information is displayed exactly as it appears in the file.

## Context Prefixes

Microsoft Help databases use several context prefixes. A context prefix is a single letter followed by a period. It appears before a context string and has a predefined meaning. You may see these contexts in the resulting text file when you decode a Microsoft help database.

The context prefixes shown in Table 18.4 are used by Microsoft to mark product-specific features. They appear in decompressed databases. However, you do not need to add them to the files you write.

**Table 18.4 Microsoft Product Context Prefixes**

Prefix	Purpose
d.	Dialog box. The context string for the Help on a dialog box is d. followed by the number assigned to that dialog box.
e.	Error number. If a product supports the error numbering used by Microsoft languages, it displays Help for each error using this prefix.

**Table 18.4 Microsoft Product Context Prefixes** (*continued*)

Prefix	Purpose
<b>h.</b>	Help item. The context string for miscellaneous Help is <code>h.</code> followed by an assigned string. These strings are described in Table 18.5. For example, most Help readers look for the context string <code>h.contents</code> when Contents is chosen from the Help menu.
<b>m.</b>	Menu item. The strings that can follow <code>h.</code> are defined by the access keys for the product's menu items. For example, the Exit command on the File menu is accessed by ALT+F, X. The context string for Help on the command is <code>m.f.x.</code>
<b>n.</b>	Message number. The context string for the Help on a message box is <code>n.</code> followed by the number assigned to that message box.

You can use the `h.` prefix, shown in Table 18.5, to identify standard Help-file contexts. For instance, **h.default** identifies the default Help screen (the screen that usually appears when you select top-level Help).

**Table 18.5 Standard h. Contexts**

Context	Description
<b>h.contents</b>	The table of contents for the Help file. You should also define the string "contents" for direct reference to this context.
<b>h.default</b>	The default Help screen, typically displayed when the user presses SHIFT+F1 to get the "top level" in some applications.
<b>h.index</b>	The index for the Help file. You can also define the string "index" for direct reference to this context.
<b>h.pg1</b>	The Help text that is logically first in the file. This is used by some applications in response to a "go to the beginning" request made within the Help window.
<b>h.title</b>	The title of the Help database.



## Browser Utilities

This chapter describes three utilities:

- ◆ Microsoft Browser Database Maintenance Utility (BSCMAKE) version 2.00
- ◆ Microsoft Browse Information Compactor (SBRPACK) version 2.00
- ◆ Microsoft Cross-Reference Utility (CREF) version 6.00

These utilities build a browser database for use with the Microsoft Source Browser, a feature of the Microsoft Programmer's Workbench (PWB). As a navigation tool, the browser gives you the means to move around quickly in a large project and find pieces of code in your source and include files. As an interactive program database, the browser can answer questions about where functions are invoked or where variables and types are used. The browser can also generate useful outlines, call trees, and cross-reference tables.

When you tell PWB to create a browser database (.BSC file) for the program you are building, PWB automatically calls BSCMAKE. You do not need to know how to run BSCMAKE to create your database in PWB. However, you may want to read this chapter to understand the PWB options available to modify the database. For information on how to create and use a browser database in PWB, see "Using the Source Browser" in Chapter 5.

If you build your program outside of PWB, you can still create a custom browser database that you can examine with the Browser in PWB. Run the BSCMAKE utility to build the database from .SBR files created during compilation. You might need to run SBRPACK to provide more efficiency during the build. This chapter describes how to use both these utilities to create your browser database. For further information, see "Building Databases for Non-PWB Projects" on page 94.

---

**Note** BSCMAKE is the successor to the Microsoft PWBRMAKE Utility. To allow existing makefiles to remain compatible, a file called PWBRMAKE.EXE is provided with BSCMAKE. This version of PWBRMAKE calls BSCMAKE using the arguments and options specified on the PWBRMAKE command line.

---

## Overview of Database Building

BSCMAKE can build a new database from newly created .SBR files. It can also maintain an existing database using .SBR files for object files that have changed since the last build. The following sections describe how .SBR files are created, what you need to know to build a database, and how you can make the database-building process more efficient.

### Preparing to Build a Database

The input files for BSCMAKE are .SBR files that you create when you compile or assemble your source files. When you build or update your browser database, all .SBR files for your project must be available on disk. To create an .SBR file, specify the appropriate command-line option to the compiler or assembler (shown in parentheses below). The following products generate .SBR files:

- ◆ Microsoft MASM versions 6.0 and later (/FR or /Fr)
- ◆ Microsoft C Compiler versions 6.0 and later (/FR or /Fr)
- ◆ Microsoft FORTRAN versions 5.1 and later (/FR or /Fr)
- ◆ Microsoft Basic versions 7.1 and later (/FBr or /FBx)
- ◆ Microsoft COBOL versions 4.0 and later (BROWSE)

The above options /FR, /FBx, and BROWSE put all possible information into the .SBR file. The options /Fr and /FBr omit local symbols from the .SBR file. (If the .SBR file was created with all possible information, you can still omit local symbols by using BSCMAKE's /El option; see page 620.)

Database building can be more efficient if the .SBR files are first packed by SBRPACK. The Microsoft C Compiler (CL) versions 7.0 and later automatically calls SBRPACK when it creates an .SBR file. (If you want to prevent packing, specify CL's /Zn option.) Other Microsoft language products do not call SBRPACK. Before you run BSCMAKE, you may want to run SBRPACK on any .SBR files that were not previously packed. See "SBRPACK" on page 623.

You can create an .SBR file without performing a full compile. For example, you can specify the ML or CL /Zs option to perform a syntax check and still generate an .SBR file if you specify /FR or /Fr.

### How BSCMAKE Builds a Database

BSCMAKE builds or rebuilds a database in the most efficient way it can. To avoid some potential problems, it is important to understand the database-building process.

When BSCMAKE builds a database, it truncates the .SBR files to zero length. During a subsequent build of the same database, a zero-length (or empty) .SBR file tells BSCMAKE that the .SBR file has no new contribution to make. It lets BSCMAKE know that an update of that part of the database is not required and an incremental build will be sufficient. During every build (unless the /n option is specified), BSCMAKE first attempts to update the database incrementally by using only those .SBR files that have changed.

BSCMAKE looks for a .BSC file that has the name specified with the /o option; if /o is not specified, BSCMAKE looks for a file that has the base name of the first .SBR file and a .BSC extension. If the database exists, BSCMAKE performs an incremental build of the database using only the contributing .SBR files. If the database does not exist, BSCMAKE performs a full build using all .SBR files.

### Requirements for a Full Build

For a full build to succeed, all specified .SBR files must exist and must not be truncated. If any .SBR file is truncated, you must first rebuild it (by recompiling or assembling) before running BSCMAKE.

### Requirements for an Incremental Build

For an incremental build to succeed, the .BSC file must exist. All contributing .SBR files, even empty files, must exist and must be specified on the BSCMAKE command line. If you omit an .SBR file from the command line, BSCMAKE removes its contribution from the database.

## Methods for Increasing Efficiency

The database-building process can require large amounts of time, memory, and disk space. However, there are several ways to reduce these requirements.

### Managing Memory Under MS-DOS

Building a database uses a lot of memory. Large projects benefit the most from use of the Source Browser, but under MS-DOS their large size can cause BSCMAKE to run out of memory. There are several ways to run BSCMAKE under MS-DOS that make use of virtual memory and extended memory. The commands to run these forms of BSCMAKE are described in “System Requirements for BSCMAKE” on page 618.

### Making a Smaller Database

Smaller databases take less time to build, use up less space on disk, have a lower risk of causing BSCMAKE to run out of memory, and run faster in the browser. The following list gives some methods of making a smaller database:

- ◆ Use BSCMAKE options to exclude information from the database.

- ◆ Omit local symbols in one or more .SBR files when compiling or assembling.
- ◆ If an object file does not contain information that you need for your current stage of debugging, omit its .SBR file when rebuilding the database.

## Saving Build Time and Disk Space

Unreferenced definitions cause .SBR files to take up more disk space and cause BSCMAKE to run less efficiently. The SBRPACK utility removes unreferenced definitions from .SBR files. For more information, see “SBRPACK” on page 623.

## Using C/C++ Precompiled Headers

Using precompiled headers speeds up BSCMAKE because the browser information for the precompiled code is generated only when the .PCH file is created. The browser information is not replicated in each source file’s browser file, as it is when you do not use precompiled headers. This reduces the size of .SBR files for object files that use precompiled headers and makes database building faster. Also, less disk space is used.

# BSCMAKE

The Microsoft Browser Database Maintenance Utility (BSCMAKE) converts .SBR files created by a compiler or assembler into database files that can be read by the PWB Source Browser. The filename of the resulting browser database has the extension .BSC. For more information on the browser, see “Using the Source Browser” in Chapter 5.

## System Requirements for BSCMAKE

BSCMAKE version 2.00 exists as two executable files. The form of BSCMAKE that you run is determined by your computer’s memory. The following executable files are discussed in this section:

- ◆ BSCMAKE.EXE for MS-DOS; can use only extended memory
- ◆ BSCMAKEV.EXE for MS-DOS; can use virtual and extended memory

BSCMAKE can use either virtual memory or extended memory (or both) to avoid running out of memory. BSCMAKE.EXE uses extended memory if available. If extended memory is unavailable, BSCMAKE runs under MS-DOS in real mode. The command to invoke this version of BSCMAKE.EXE is:

```
BSCMAKE
```

followed by the rest of the command line. For best results, the sum of available conventional and extended memory should be half the size of the disk space occupied by the finished database.

If your computer does not have extended memory or if it is insufficient for your database, you can use virtual memory. BSCMAKEV.EXE uses extended memory if it is available. If extended memory is unavailable or insufficient, BSCMAKEV uses virtual memory, copying information to your disk as needed during the database build. Swapping to disk is slower but can overcome a shortage of memory. The command to invoke this form of BSCMAKE is:

```
BSCMAKEV
```

followed by the rest of the command line.

To prevent BSCMAKE or BSCMAKEV from using extended memory, specify the */r* option as the first option on the command line.

## The BSCMAKE Command Line

To run BSCMAKE, use the following command line:

```
BSCMAKE [[options]] sbrfiles
```

This syntax applies to all forms of BSCMAKE. Specify either BSCMAKE or BSCMAKEV in the first position on the command line.

Options can appear only in the *options* field on the command line. If the */r* option is used, it must be first.

The *sbrfiles* field specifies one or more .SBR files created by a compiler or assembler. If you specify more than one file, separate the names with spaces or tabs. You must specify the extension; there is no default. You can specify a path with the filename, and you can use operating-system wildcards (\* and ?).

During an incremental build, you can specify new .SBR files that were not part of the original build. If you want all contributions to remain in the database, you must specify all .SBR files (including truncated files) that were originally used to create the database. If you omit an .SBR file, that file's contribution to the database is removed.

Do not specify a truncated .SBR file for a full build. A full build requires contributions from all specified .SBR files. Before you perform a full build, recompile and create a new .SBR file for each empty file.

### Example

The following command runs BSCMAKE to build a file called MAIN.BSC from three .SBR files:

```
BSCMAKE main.sbr file1.sbr file2.sbr
```

## BSCMAKE Options

This section describes the options available for controlling BSCMAKE. Several options control the content of the database by telling BSCMAKE to exclude or include certain information. The exclusion options can allow BSCMAKE to run faster and may result in a smaller .BSC file. Option names are case sensitive (except for /HELP and /NOLOGO).

*/Ei filename*

*/Ei (filename...)*

Excludes the contents of the specified include files from the database. To specify multiple files, separate the names with spaces and enclose the list in parentheses. Use /Ei along with the /Es option to exclude files not excluded by /Es.

*/El*

Excludes local symbols. The default is to include local symbols in the database. For more information about local symbols, see "Preparing to Build a Database" on page 616.

*/Em*

Excludes symbols in the body of macros. Use /Em to include only the names of macros in the database. The default is to include both the macro names and the result of the macro expansions.

*/Er symbol*

*/Er (symbol...)*

Excludes the specified symbols from the database. To specify multiple symbol names, separate the names with spaces and enclose the list in parentheses.

*/Es*

Excludes from the database every include file specified with an absolute path or found in an absolute path specified in the INCLUDE environment variable. (Usually, these are the system include files, which contain a lot of information that you may not need in your database.) This option does not exclude files specified without a path or with relative paths or found in a relative path in INCLUDE. You can use the /Ei option along with /Es to exclude files that /Es does not exclude. If you want to exclude only some of the files that /Es excludes, use /Ei instead of /Es and list the files you want to exclude.

*/HELP*

Calls the QuickHelp utility. If BSCMAKE cannot find the Help file or QuickHelp, it displays a brief summary of BSCMAKE command-line syntax.

*/lu*

Includes unreferenced symbols. By default, BSCMAKE does not record any symbols that are defined but not referenced. If an .SBR file has been processed by SBRPACK, this option has no effect for that input file because SBRPACK has already removed the unreferenced symbols.

*/n*

Forces a nonincremental build. Use */n* to force a full build of the database whether or not a .BSC file exists and to prevent .SBR files from being truncated. See “Requirements for a Full Build” on page 617.

*/NOLOGO*

Suppresses the BSCMAKE copyright message.

*/o filename*

Specifies a name for the database file. By default, BSCMAKE assumes that the database file has the base name of the first .SBR file and a .BSC extension.

*/r*

Prevents BSCMAKE from using extended memory under MS-DOS. The */r* option must appear first in the options field on the command line and cannot appear in a response file. BSCMAKE.EXE and BSCMAKEV.EXE are extender-ready and use extended memory if it exists. This option forces BSCMAKE to use only conventional memory and forces BSCMAKEV to use conventional memory and virtual memory. For more information, see “System Requirements for BSCMAKE” on page 618.

*/S filename*

*/S (filename...)*

Tells BSCMAKE to process the specified include file the first time it is encountered and to exclude it otherwise. Use this option to save processing time when a file (such as a header, or .H, file for a .C source file) is included in several source files but is unchanged by preprocessing directives each time. You may also want to use this option if a file is changed in ways that are unimportant for the database you are creating. To specify multiple files, separate the names with spaces and enclose the list in parentheses. If you want to exclude the file every time it is included, use the */Ei* or */Es* option.

*/v*

Provides verbose output, which includes the name of each .SBR file being processed and information about the complete BSCMAKE run.

*/?*

Displays a brief summary of BSCMAKE command-line syntax.

### Example

The following command line tells BSCMAKE to use virtual memory and conventional memory (but not extended memory) to do a full build of MAIN.BSC from three .SBR files. It also tells BSCMAKE to exclude duplicate instances of TOOLBOX.H:

```
BSCMAKEV /r /n /S toolbox.h /o main.bsc file1.sbr file2.sbr file3.sbr
```

## Using a Response File

You can provide part or all of the command-line input in a response file, which is a text file that contains options and/or filenames.

Specify the response file using the following syntax:

```
BSCMAKE @responsefile
```

This syntax applies to all forms of BSCMAKE; you can specify BSCMAKE or BSCMAKEV in the first position on the command line. Only one response file is allowed. You can specify a path with *responsefile*. Precede the filename with an at sign (@). BSCMAKE does not assume an extension. You can specify additional *sbrfiles* on the command line after *responsefile*. If you use */r*, you must specify it on the command line before the response file.

In the response file, specify the input to BSCMAKE in the same order as you would on the command line. Separate the command-line arguments with one or more spaces, tabs, or newline characters.

### Example

The following command calls BSCMAKE using the prog1.txt response file:

```
BSCMAKE @prog1.txt
```



### Example

The following is a listing of prog1.txt:

```

/n /v /o main.bsc /El
/S (
toolbox.h
verdate.h c:\src\inc\screen.h
)
/Er ( HWND HpOfSbIb
LONG LPSTR
NEAR NULL
PASCAL
VOID
WORD
)
file1.sbr file2.sbr file3.sbr file4.sbr

```

The prog1.txt response file instructs BSCMAKE to:

- ◆ Perform a nonincremental build (/n, /o) of MAIN.BSC from the FILE1, FILE2, FILE3, and FILE4 \*.SBR files.
- ◆ Report full information about the complete BCSMAKE run (/v).
- ◆ Exclude local symbols (/El), and process the include files TOOLBOX.H, VERDATE.H, and SCREEN.H files only once (/S).
- ◆ Exclude the HWND, HpOfSbIb, LONG, LPSTR, NEAR, NULL, PASCAL, VOID, and WORD symbols (/Er).

## BSCMAKE Exit Codes

BSCMAKE returns an exit code (also called return code or error code) to the operating system or the calling program. You can use the exit code to control the operation of batch files or makefiles.

Code	Meaning
0	No error
1	Command-line error
4	Fatal error during database build

## SBRPACK

The Microsoft Browse Information Compactor (SBRPACK) removes unreferenced symbols from .SBR files before they are processed by BSCMAKE. This can result in smaller .SBR files, which allow BSCMAKE to run faster. Smaller .SBR files also save space on disk.

Packing .SBR files is optional. The Microsoft C Compiler versions 7.0 (CL) and later automatically call SBRPACK when you specify either /FR or /Fr to create an .SBR file. If you specify /Zn in addition to one of these options, CL does not call SBRPACK to pack the .SBR file. Other compilers and assemblers do not pack .SBR files. You may want to use SBRPACK to pack an .SBR file that was created without packing.

SBRPACK.EXE version 2.00 runs under real-mode MS-DOS. It does not use virtual memory, expanded memory, or extended memory.

## Overview of SBRPACK

When symbols such as functions or data are defined but not referenced, you can use SBRPACK to remove them from the .SBR files before the files are processed by BSCMAKE. A common source of unreferenced symbols is an include, or header, file. When a source file includes a header file, it often brings in a large number of unreferenced definitions. Therefore, the .SBR file that results from compiling this source file can contain a large amount of unneeded information. The time or disk space saved by SBRPACK is directly related to the number of unreferenced symbols in the .SBR files.

If SBRPACK is not used, BSCMAKE will remove the same information (unless you specify BSCMAKE's /lu option to preserve this information). However, BSCMAKE can run more efficiently if the .SBR files are first processed by SBRPACK. The time it takes to run both utilities can be less than if BSCMAKE is used alone, especially under real-mode MS-DOS or under extended MS-DOS using virtual memory.

You can run SBRPACK every time you create an .SBR file, or you can run it just once before running BSCMAKE. If you need to save room on your disk, run SBRPACK after every compilation. The .SBR files will then be stored in a more compact form. If you need to accelerate your program-build process, run SBRPACK only as needed, just before running BSCMAKE. The example in the following section shows how to run SBRPACK to perform each kind of efficiency.

## The SBRPACK Command Line

To run SBRPACK, use the following command line:

```
SBRPACK [[option]] sbrfiles
```

Option names are not case sensitive. Only the /NOLOGO option applies to a packing session; the other options provide help and then halt SBRPACK.

The *sbrfiles* field specifies one or more .SBR files created by a compiler or assembler. If you specify more than one file, separate the names with spaces or

tabs. You must specify the extension; there is no default. You can specify a path with the filename, and you can use operating-system wildcards (\* and ?).

You do not specify a name for the resulting files; SBRPACK saves the changed files under their original name. If you want to preserve the original files, copy them to another name before running SBRPACK.

SBRPACK has the following options:

**/HELP**

Calls the QuickHelp utility. If SBRPACK cannot find the Help file or QuickHelp, it displays a brief summary of SBRPACK command-line syntax.

**/NOLOGO**

Suppresses the SBRPACK copyright message.

**/?**

Displays a brief summary of SBRPACK command-line syntax.

### Example

The following commands assemble a file using the Microsoft Macro Assembler (ML), compile a file using the Microsoft C Optimizing Compiler (CL), and build a browser database using both SBRPACK and BSCMAKE:

```
ML /FR /c prog1.asm
CL /FR /c prog2.c
SBRPACK prog2.sbr
.
.
.
BSCMAKE *.sbr
```

These commands run SBRPACK every time an .SBR file is created. A separate SBRPACK command isn't needed for PROG2.SBR because CL calls SBRPACK automatically. Later in the program-building session, BSCMAKE builds a database and names it PROG1.BSC. This combination of commands saves space on disk during the program-building session.

The same commands can be configured to create the same database but save running time. In the following example, SBRPACK is called only when BSCMAKE is about to run. If these commands are in a makefile, time is saved if the program-building sequence stops before a database is built.

```
ML /FR /c prog1.asm
CL /FR /Zn /c prog2.c
.
.
.
SBRPACK *.sbr
BSCMAKE *.sbr
```

## SBRPACK Exit Codes

SBRPACK returns an exit code (also called return code or error code) to the operating system or the calling program. You can use the exit code to control the operation of batch files or makefiles.

Code	Meaning
0	No error
1-4	Fatal SBRPACK error

Each fatal error generates a specific exit code. For individual exit codes associated with each error, see Appendix A.

## CREF

This section contains information on the purpose and use of the Microsoft Cross-Reference Utility (CREF) Version 6.00.

The Microsoft Cross-Reference Utility (CREF) creates a cross-reference listing of all symbols in an assembly-language program. A cross-reference listing is an alphabetical list of symbols followed by references to where a symbol appears in the source code.

CREF is intended for use as a debugging aid to speed up the search for symbols encountered during a debugging session. The cross-reference listing, together with the symbol table created by the assembler, can make debugging and correcting a program easier.

## Using CREF

CREF creates a cross-reference listing for a program by converting PWB Source Browser database files (those ending with a .BSC or an .SBR extension) into a readable ASCII file.

### Command-Line Syntax

CREF *crossreferencefile* [[, *crossreferencelisting*] [[:]]

*crossreferencefile*

Source Browser database file. Default filename extension is .BSC.

*crossreferencelisting*

Readable ASCII cross-reference listing. Default filename extension is REF. If this filename is not supplied on the command line, the base filename of the database file is used and the REF extension is added.

## Using Prompts to Create a Cross-reference Listing

You can direct CREF to prompt you for the files it needs by starting CREF with just the command name (CREF). CREF prompts you for the input it needs by displaying the following lines, one at a time:

```
Cross-Reference [.BSC]:
Listing [filename.REF]:
```

The prompts correspond to the fields of the CREF command lines. CREF waits for you to respond to each prompt before printing the next one. You must type a cross-reference filename (extension is optional) at the first prompt. For the second prompt, you can either type a filename or press the ENTER key to accept the default displayed in brackets after the prompt.

## Use of BSCMAKE with CREF

Note that the CREF utility can create reports only from the final form of the Source Browser database files. These files end in .BSC (Browser Source Cache), and are created by the utility BSCMAKE. Because ML creates an intermediate Source Browser file (with the filename extension .SBR), CREF invokes BSCMAKE to create a .BSC file from a single .SBR file input. BSCMAKE takes as input the .SBR files created by ML, merges them with other .SBR files created from other assembly-language source modules (if any exist), and creates a .BSC file as the result. The .BSC file contains all of the information (across multiple modules, if necessary) to provide a comprehensive cross-listing file for an entire project.

CREF will invoke BSCMAKE only when a single .SBR file is given as input to the utility; therefore, you must create a .BSC database file from the assembler-generated .SBR files before invoking CREF. An example of running BSCMAKE is:

```
BSCMAKE FILENAME.SBR FILE2.SBR FILE3.SBR ... FILEN.SBR
```

This example creates a .BSC file using the base name of the first .SBR file on the command line. In this case, the resultant file would be named FILENAME.BSC.

By using the .BSC Source Browser database files, CREF is able to provide cross-reference files for either a single assembly-language module or for an entire multimodule assembly-language project. Below are the steps necessary for both scenarios.

For more information on BSCMAKE options, see page 620, or type BSCMAKE /? at the command line to get a quick-reference screen.

## Creating Single-Module Cross-reference Listings

Using ML with the /FR switch, create an .SBR file for the assembly-language module. An example is:

```
ML /c /FR filename.ASM
```

This creates a file FILENAME.SBR (as well as FILENAME.OBJ).

Invoke CREF using the database file created above (FILENAME.SBR) as the input cross-reference file. An example of this is:

```
CREF FILENAME.SBR, FILENAME.REF
```

This creates the cross-reference listing FILENAME.REF.

Note that because CREF is capable only of reading Source Browser .BSC database files, the BSCMAKE utility is automatically invoked to convert the .SBR on the command line into a .BSC file.

## Creating Multimodule Cross-reference Listings

Using ML with the /FR switch, create an .SBR file for each of the assembly-language modules. An example is:

```
ML /c /FR *.ASM
```

This creates a file FILENAME.SBR (as well as FILENAME.OBJ).

Invoke CREF using the database file created above (FILENAME.BSC) as the input cross-reference file. An example of this is:

```
CREF FILENAME.BSC, FILENAME.REF
```

The cross-reference listing FILENAME.REF is created. This particular example will have all of the symbols from all of the modules in one cross-reference listing file.

## Reading Cross-reference Listings

The cross-reference listing contains the name of each symbol defined in your program. Each name is followed by a list of source filenames in which the symbol appears. Each source name is then followed by a list of line numbers representing the line or lines in the source file in which a symbol is referenced.

Line numbers in which a symbol is defined are marked with the number sign (#).

Below is a sample assembly-language source-code module, followed by the resulting cross-reference listing file.

### Example

```
.DOSSEG .MODEL small, pascal
.STACK 100h
.DATA PUBLIC message, lmessage
message BYTE "Hello World!!!!" lmessage EQU $-message
.CODE
.STARTUP
EXTERN display:NEAR
call display
mov ax, 4C00h
int 21h
.EXIT END
```

Example Reference Listing (Created from above source-code module) -----

```
-----
Microsoft Cross-Reference Version 6.00 Wed Nov 18 15:47:26 1992
Symbol Cross-Reference (# definition) Cref-1
@code ..\hello.asm . . . . . 2
# @CodeSize ..\hello.asm . . . . . 2
# @data ..\hello.asm . . . . . 2
# @DataSize ..\hello.asm . . . . . 2
# @fardata ..\hello.asm . . . . . 2
# @fardata? ..\hello.asm . . . . . 2
# @Interface ..\hello.asm . . . . . 2
# @Model ..\hello.asm . . . . . 2
# @stack ..\hello.asm . . . . . 2
# @Startup ..\hello.asm . . . . . 14
# _DATA ..\hello.asm . . . . . 2
# _TEXT ..\hello.asm . . . . . 2# 12
DGROUP ..\hello.asm . . . . . 2# 2 14
display ..\hello.asm . . . . . 16 17 <Unknown>. . . . .
# hello.asm ..\hello.asm . . . . . 1
# lmessage ..\hello.asm . . . . . 10# 7
message ..\hello.asm . . . . . 9# 10 7
STACK ..\hello.asm . . . . . 4
```

## Difference from Previous Releases

### Use Differences

ML/MASM no longer generates a .CRF assembler-specific binary file. Instead, CREF 6.0 uses the generic Source Browser database file (.BSC).

Because of this, CREF can actually be used with any source-code module or project that is compiled/assembled by a Microsoft product that creates .SBR files.

Creating multimodule cross-reference listing files is another advantage of using .BSC Browser database files. Previous releases of CREF were limited to single modules.

### **Listing Differences**

All line numbers that are reported are relative to the actual source-code module, not the assembler-generated listing file. This is a direct result of using the Source Browser database files (.BSC). These files are not directly related to MASM listings and are generic across Microsoft language products.



## CHAPTER 20

## Using Other Utilities

This chapter explains how to use the following utilities:

- ◆ CVPACK (Microsoft Debugging Information Compactor) version 4.05—Prepares executable files for use with the CodeView debugger by reducing the size of debugging information within the files.
- ◆ H2INC (Microsoft C Header Translation Utility) version 1.01—Translates C header files into MASM-compatible include files.
- ◆ IMPLIB (Microsoft Import Library Manager) version 1.40—Creates an import library for use in resolving external references from a Windows-based program to a dynamic-link library (DLL).
- ◆ RM (Microsoft File Removal Utility) version 2.00  
UNDEL (Microsoft File Undelete Utility) version 2.00  
EXP (Microsoft File Expunge Utility) version 2.00
- ◆ WX/WXServer Utility version 1.50—Runs a Windows-based program in an MS-DOS session.

### CVPACK

This section describes the Microsoft Debugging Information Compactor (CVPACK) version 4.05. CVPACK 4.05 prepares an executable file for use with the Microsoft CodeView debugger version 4.05.

You should always use matching versions of CVPACK and CodeView. Earlier formats of debugging information and CVPACK-packing are not compatible with CodeView 4.05. If an executable file contains debugging information in an earlier format but has not been packed, packing with CVPACK 4.05 is all that is needed for the file to run in CodeView 4.05. However, if the executable file has been packed with an earlier version of CVPACK, you must relink the file.

Also, executable files packed using CVPACK 4.05 are not compatible with earlier versions of CodeView. The debugging information produced by Microsoft compilers and packed by CVPACK 4.05 is for use with CodeView 4.05 and is not compatible with earlier versions of CodeView.

## Overview of CVPACK

An executable file to be run under CodeView 4.05 must first be packed by CVPACK 4.05. The debugging information in the file must be in the form given in the Microsoft Symbolic Debugging Information specification. This is the format supported by current Microsoft compilers and linkers.

LINK versions 5.30 and later automatically call CVPACK when you specify LINK's /CO option. You do not need to run CVPACK as a separate step. However, if you want to use CodeView to debug a file that was built by another linker (either an earlier Microsoft linker or a third-party linker), you must run CVPACK to convert the executable file to the current CodeView format. Be sure that the executable file has not been packed by an earlier version of CVPACK; if it has, you must relink the file.

CVPACK compresses debugging information by removing duplicate type definitions. To be removed by CVPACK, the definitions must be absolutely identical. For example, if a structure defined in two modules contains a pointer to another structure, but the second structure is defined in only one module, the pointer size is unknown in the other module. In this case, CVPACK cannot pack the duplicate structure definitions in the same way, which causes less efficient compression.

CVPACK can pack an executable that is in .COM format. The linker puts debugging information for a .COM file into a file with the same base name as the executable file and with a .DBG extension. When you specify a .COM file to be packed, CVPACK looks for a .DBG file with the same base name and in the same location as the .COM file.

## The CVPACK Command Line

To run CVPACK, use the following command line:

```
CVPACK [[option]] exefile
```

The *exefile* specifies a single executable file to be packed. You can specify a path with the filename. If you do not specify an extension, CVPACK assumes the default extension .EXE.

## CVPACK Options

CVPACK has the following options; the option names are not case sensitive:

**/H[[ELP]]**

Calls the QuickHelp utility. If CVPACK cannot find the help file or QuickHelp, it displays a brief summary of CVPACK command-line syntax.

**/M[[INIMUM]]**

Preserves only public symbols and line numbers. All other debugging information is removed from the executable file.

**/N[[OLOGO]]**

Suppresses the CVPACK copyright message.

**/?**

Displays a brief summary of CVPACK command-line syntax.

---

**Note** The **/P** option is not a valid option for the current version of CVPACK. Using this option causes an error.

---

### Example

The following command packs the file PROJECT.EXE, located in the directory \TEST on the current drive:

```
CVPACK \TEST\PROJECT.EXE
```

## CVPACK Exit Codes

CVPACK returns an exit code (also called return code or error code) to the operating system or the calling program. You can use the exit code to control the operation of batch files or makefiles.

Code	Meaning
0	No error
1	Program error caused by commands or files given as input to CVPACK

## H2INC

This version (1.01) of H2INC now includes the following:

- ◆ The number of C keywords, preprocessor keywords and preprocessor pragmas has been expanded to maintain compatibility with Microsoft C/C++ Version 7.0.
- ◆ Invalid command-line options generate a warning, rather than a fatal error.

- ◆ OPTION CASEMAP: NONE is automatically added in the generated \*.INC.
- ◆ A new warning (HI4010) is generated whenever an attempt is made to redefine a MASM keyword, or whenever a typedef statement converts to a type with the same name as the type.

The H2INC utility translates C header files into MASM-compatible include files. C header files normally have the extension .H; MASM include files normally have the extension .INC. This is the origin of the program's name: "H to INC."

H2INC simplifies porting data structures from your C programs to MASM programs. This is especially useful when you have:

- ◆ A program that mixes C code and MASM code with globally accessible data structures.
- ◆ A program prototyped in C that you're translating to MASM for compactness and fast execution.

The H2INC program translates data declarations, function prototypes, and type definitions. H2INC does not convert C code into MASM code. When H2INC encounters a C statement that would compile into executable code, H2INC ignores the statement and issues a warning message to the standard output.

H2INC accepts C source code that is compatible with Microsoft C versions 6.0 and later, and creates include files suitable for MASM versions 6.0 and later. These include files will not work with versions of MASM earlier than version 6.0.

H2INC is designed to translate project header files that you have written specifically for translation to MASM versions 6.0 and later include files. It is not designed to translate header files such as PM.H and WINDOWS.H.

This section explains how H2INC performs the C code translation and how the command-line options control the conversions.

## Basic H2INC Operation

H2INC is designed to provide automatic translation of C declarations that you need to include in the MASM portions of an application. However, the set of C statements processed by H2INC must be those needed by and interpretable by MASM. H2INC converts only function prototypes, some preprocessor directives, and C declarations outside the scope of procedures. For example, H2INC translates the C statement

```
#define MAX_EMPLOYEES 400
```

into this MASM statement:

```
MAX_EMPLOYEES EQU 400t
```

The *t* specifies the decimal radix.

H2INC does not translate C code into MASM code. Statements such as the following are ignored:

```
printf( "This is an executable statement.\n" );
```

H2INC translates declarations, not executable code.

By default, H2INC creates a single .INC file. If the C header file includes other header files, the statements from the original and nested files are translated and combined into one .INC file. This behavior can be changed with the /Ni option.

The program also preprocesses some statements, just as the C preprocessor would. For example, given the following statements, if VERSION is not defined, H2INC ignores the **#ifdef** block.

```
#ifdef VERSION
#define BOX_VALUE 4
#endif
```

If VERSION is defined, H2INC translates the statements inside the block from C syntax to MASM syntax.

H2INC normally discards comments. If you use the /C option, C comments are passed to the output file. If the line starts with a /\* or //, the comment specifier is converted to a semicolon (;). If the line is part of a multiline comment, a semicolon is prefixed to each line.

H2INC ignores anything that is not a comment or that cannot be translated. These items do not appear in the output file. If H2INC encounters an error, it stops translating and deletes the resulting .INC file.

## H2INC Syntax and Options

To run H2INC, type H2INC at the command-line prompt, followed by the options desired and the names of the .H files you want to convert:

```
H2INC [options] file.H ...
```

You can specify more than one *file.H*. File names are separated by a space. The contents of each *file.H* are translated into a single file in the current directory with the name *file.INC*. The original *file.H* is not altered.

The following lists describe the available options. You can specify more than one option. Note that the options are case sensitive except for /HELP.

H2INC recognizes `/?` to display a summary of H2INC syntax, and `/HELP` to invoke QuickHelp for H2INC. If QuickHelp is not available, H2INC displays a short list of H2INC options. This option is not case sensitive.

H2INC recognizes but ignores C 6.0 options that aren't specified in the following two lists.

## Options Directly Affecting H2INC Output

This list describes the options that directly affect the H2INC output:

Option	Action
<code>/C</code>	Passes comments in the <code>.H</code> file to the <code>.INC</code> file.
<code>/Fa [[filename]]</code>	Specifies that the output file contain only equivalent MASM statements. This is the default. If specified, the filename overrides the default, keeping the base name of the C header files and adding the <code>.INC</code> extension.
<code>/Fc [[filename]]</code>	Specifies that the output file contain equivalent MASM statements plus original C statements converted to comment lines.
<code>/Mn</code>	Assumes the <code>.MODEL</code> directive is not specified for the MASM source or the generated <code>.INC</code> files. Instructs H2INC to declare explicitly the distances for all pointers and functions.
<code>/Ni</code>	Suppresses the expansion of nested include files.
<code>/Zu</code>	Makes all structure and union tag names unique.

## Options Indirectly Affecting H2INC Output

This list describes the options that indirectly affect the H2INC output:

Option	Action
<code>/AC</code>	Specifies compact memory model.
<code>/AH</code>	Specifies huge memory model.
<code>/AL</code>	Specifies large memory model.
<code>/AM</code>	Specifies medium memory model.
<code>/AS</code>	Specifies small memory model, the default.
<code>/AT</code>	Specifies tiny memory model ( <code>.COM</code> ).
<code>/D[[const[[=value]] ]]</code>	Defines a constant or macro.
<code>/G0</code>	Enables 8086/8088 instructions (default).
<code>/G1</code>	Enables 80186/80188 instructions.
<code>/G2</code>	Enables 80286 instructions.

Option	Action
/G3	Enables 80386 instructions. Changes the default word size to <b>DWORD</b> .
/G4	Enables 80486 instructions. Changes the default word size to <b>DWORD</b> .
/Gc	Specifies Pascal as the default calling convention.
/Gd	Specifies C as the default calling convention for functions (default).
/Gr	Specifies the <b>_fastcall</b> calling convention for functions. Generates a warning since H2INC does not translate <b>_fastcall</b> functions and prototypes.
/Ht	Enables generation of text equates. By default, text items are not translated.
/Ipaths	Searches named paths for include files before searching the paths in the INCLUDE environment variable. Paths are separated with a semicolon (;).
/J	Changes default character type from <b>signed char</b> to <b>unsigned char</b> .
/nologo	Suppresses display of the sign-on banner.
/Tc [[filename]]	Enables the processing of file whose name does not end in .H.
/uident	“Undefines” one of the predefined identifiers.
/U	“Undefines” all predefined identifiers.
/w	Suppresses compiler warning messages; same as /W0.
/W0	Suppresses all warning messages.
/W1	Displays level 1 warning messages (default).
/W2	Displays level 1 and level 2 warning messages.
/W3	Displays level 1, 2, and 3 warning messages.
/W4	Displays all warning messages.
/X	Excludes search for include files in the standard places.
/Za	Disables language extensions (allows ANSI standard only).
/Zc	Causes functions declared as <b>_pascal</b> to be case insensitive.
/Ze	Enables language extensions (default).
/Zn <i>string</i>	Adds <i>string</i> to all names generated by H2INC. Used to eliminate name conflicts with other H2INC-generated include files.
/Zp{1 2 4}	Packs structure on a 1-, 2-, or 4-byte boundary, following C packing rules. Default is /Zp2.

## Converting Data and Data Structures

The primary use of H2INC is to convert data automatically from C format into MASM format. This section shows how H2INC converts constants, variables, pointers, and other C data structures to definitions recognizable to MASM.

The previous version of H2INC required you to specify **OPTION CASEMAP:NONE** in any MASM files that included .INC files generated with H2INC. H2INC now automatically specifies this option in the \*.INC file it generates.

### User-Defined and Predefined Constants

H2INC translates constants from C to MASM format. For example, C symbolic constants of the form

```
#define CORNERS 4
```

are translated to MASM constants of the form

```
CORNERS EQU 4t
```

in cases where CORNERS is an integer constant or is preprocessed to an integer constant. For more information on integer constants in MASM, see the *Programmer's Guide*.

When the defined expression evaluates to a noninteger value, such as a floating-point number or a string, H2INC defines the expression with **TEXT EQU** and adds angle brackets to create text macros. By default, however, these **TEXT EQU** expressions are not added to the include file. Set the /Ht option to tell H2INC to generate **TEXT EQU** expressions.

```
/* #define PI 3.1415 */  
PI TEXT EQU <3.1415>
```

H2INC uses this form when the expression is anything other than a constant integer expression. H2INC does not check the constant or string for validity, nor does it translate type-cast conversions. For example, although the following C definitions are valid, H2INC creates invalid equates without generating an error.

These C statements

```
#define INT 6  
#define FOREVER for(;;)  
#define LONG_5 (long) 5
```

generate these MASM statements:



```
INT EQU 6t
FOREVER TEXTEQU <for(;;)>
LONG_5 TEXTEQU <(long) 5>
```

The first **#define** statement is invalid because **INT** is a MASM instruction; in MASM versions 6.0 and later, instructions are reserved and cannot be used as identifiers. Any attempt to redefine a MASM keyword will result in the warning:

```
HI4010: identifier: identifier is a MASM keyword.
```

The **for** loop definition is invalid because MASM cannot assemble C code.

The long type-cast conversion is invalid because a type cannot be assigned to a numerical equate. To resolve this in the above example, the C statement

```
#define LONG_5 (long) 5
```

could be changed to:

```
#define LONG_5 5.
```

Predefined constants control the contents of .INC files.

You can make use of the following predefined constants in your C code to conditionally generate the code in .INC files. The predefined constants and the conditions under which they are defined are:

Predefined Constant	When Defined
<b>_H2INC</b>	Always defined
<b>M_I86</b>	Always defined
<b>MSDOS</b>	Always defined
<b>_MSC_VER</b>	Defined as 610 for this release
<b>M_I8086</b>	Defined if /G0 is specified
<b>M_I286</b>	Defined if /G0 is not specified
<b>NO_EXT_KEYS</b>	Defined if /Za is specified
<b>_CHAR_UNSIGNED</b>	Defined if /J is specified
<b>M_I86SM</b>	Defined if /AS is specified
<b>M_I86MM</b>	Defined if /AM is specified
<b>M_I86CM</b>	Defined if /AC is specified
<b>M_I86LM</b>	Defined if /AL is specified
<b>M_I86HM</b>	Defined if /AH is specified

For example, if your C header file includes definitions which are specific to the C portion of the program or otherwise are not appropriate for translation by H2INC, you can bracket the C-specific code with

```
#ifndef _H2INC
    /* C-specific code */
#endif
```

In this case, only the C compiler processes the bracketed code.

The `/u` and `/U` options affect these predefined constants. The `/uarg` option undefines the constant specified as the argument. The `/U` option disables the definition of all predefined constants. Neither `/u` or `/U` affects constants defined by the `/D` option.

H2INC places an **OPTION EXPR32** directive in the `.INC` file so that MASM correctly handles long integers within expressions. This means that the `.INC` files as well as all the `.ASM` files which include `.INC` files created with H2INC will resolve integer expressions in 32 bits instead of 16 bits.

This also means that if a negative number is evaluated in an expression, its value can only be used as a double word (or longer) operand.

These C statements:

```
#define MINUS_1    (-1)
#define MINUS_2    -2
```

generate these MASM statements:

```
MINUS_1 EQU 0ffffffffh
MINUS_2 EQU -2t
```

In most cases, the second behavior is more desirable, as the decimal representation can be cast within MASM to the appropriate size (with a `word ptr` operator, for example).

## Variables

H2INC translates variables from C to MASM format. For example, this C declaration

```
int my_var;
```

is translated into the MASM declaration

```
EXTERNDEF my_var:WORD
```

H2INC converts C variable types to MASM types as follows:

C Type	MASM Type
<b>char</b>	<b>BYTE</b> or <b>SBYTE</b> (controlled by /J option)
<b>signed char</b>	<b>SBYTE</b>
<b>unsigned char</b>	<b>BYTE</b>
<b>short, wchar_t</b>	<b>SWORD</b>
<b>unsigned short</b>	<b>WORD</b>
<b>int</b>	<b>SWORD</b> ( <b>SDWORD</b> with /G3 or /G4 option)
<b>unsigned int</b>	<b>WORD</b> ( <b>DWORD</b> with /G3 or /G4 option)
<b>long</b>	<b>SDWORD</b>
<b>unsigned long</b>	<b>DWORD</b>
<b>float</b>	<b>REAL4</b>
<b>double</b>	<b>REAL8</b>
<b>long double</b>	<b>REAL10</b>

H2INC always assumes that a variable is external. For example, the C declaration

```
long big_data;
```

is converted to this MASM declaration:

```
EXTERNDEF big_data:SDWORD
```

For more information on MASM data types, see the *Programmer's Guide*.

H2INC does not allocate space for arrays since all variables are assumed to be external. For example, the C declaration

```
int two_d[10][20];
```

translates to:

```
EXTERNDEF two_d:SWORD
```

H2INC does not translate static variable values, since the scope of these variables extends only to the file where they are declared. Instead, H2INC substitutes EXTERNDEF declarations for all static variables. (This includes initialized static variables.)

## Pointers

H2INC translates C pointer variables into their MASM equivalents. The C declarations

```
int *ptr_var;  
char _near *pCh;
```

are translated into these MASM statements:

```
EXTERNDEF ptr_var:PTR SWORD  
EXTERNDEF pCh:NEAR PTR SBYTE
```

If you set the `/Mn` option, H2INC specifies all distances explicitly (for example, **NEAR PTR** instead of **PTR**). If `/Mn` is not set, the distances are generated only when they differ from the default values implied by the memory model specified by the `/A` command-line option.

H2INC converts `_segment` and `_based` variables to type **WORD** in MASM.

For information about MASM pointers, see the *Programmer's Guide*.

## Structures and Unions

H2INC translates C structures and unions into their MASM equivalents. H2INC modifies the C structure or union definition to account for differences from MASM structure and union definitions. This list describes these modifications.

- ◆ C allows a structure or union variable to have the same name as the type name, but MASM does not. The H2INC `/Zu` option prevents the structure name from matching a variable or instance by prefixing every MASM structure name with `@tag_`.
- ◆ If a C structure or union definition does not have a name, H2INC supplies one for the MASM conversion. These generated structure names take the form `@tag_n`, where `n` is an integer that starts at zero and is incremented for each structure name H2INC generates.
- ◆ If the `/Zn` option is specified, H2INC inserts the given string between the underscore and the number in the generated structure names. This eliminates name conflicts with other H2INC-generated include files.
- ◆ H2INC adds the alignment value to the converted structure definition.

The following examples show how these rules are applied when converting structures. (Union conversions are not shown; they are handled identically.) These examples assume that the C header file defines an alignment value of 2. For information on alignment values, see the *Programmer's Guide*.

The following named C structure definition

```
struct file_info
{
    unsigned char  file_addr;
    unsigned int   file_size;
};
```

is converted to the following MASM form. Except for explicitly specifying the alignment value, the conversion is direct:

```
file_info          STRUCT 2t
file_addr          BYTE           ?
file_size          WORD           ?
file_info          ENDS
```

If the same C structure definition is converted using the /Zu option, the @tag\_ prefix is added to the structure's name so that the name does not duplicate the name of a structure component:

```
@tag_file_info    STRUCT 2t
file_addr          BYTE           ?
file_size          WORD           ?
@tag_file_info    ENDS
```

If the original C structure definition is modified to be an unnamed-type declaration of a specific instance (*myfile*)

```
struct
{
    unsigned char  file_addr;
    unsigned int   file_size;
} myfile ;
```

its MASM conversion looks like the following example. (The specific integer added to the @tag\_ prefix is determined by the sequence in which H2INC creates tag names.)

```
@tag_7            STRUCT 2t
file_addr          BYTE           ?
file_size          WORD           ?
@tag_7            ENDS
EXTERNDDEF        C myfile:@tag_7
```

Nested structures may have as many levels as desired; they are not limited to one level. Nested structures are “unnested” (expanded) in the correct hierarchical sequence, as shown with the C structure and H2INC-generated code in this example.

```

/* C code: */
struct phone
{
    int  areacode;
    long number;
};

struct person
{
    char  name[30];
    char  sex;
    int   age;
    int   weight;
    struct phone;
} Jim;

; H2INC generated code:
phone          STRUCT 2t
areacode       SWORD          ?
number        SDWORD         ?
phone         ENDS

person        STRUCT 2t
name          SBYTE           30t DUP (?)
sex           SBYTE           ?
age           SWORD           ?
weight        SWORD           ?
STRUCT
    areacode   SWORD           ?
    number     SDWORD         ?
ENDS
person        ENDS

EXTERNDEF     C Jim:person

```

For information on MASM structures and unions, see the *Programmer's Guide*.

## Bit Fields

H2INC translates C bit fields into MASM records. H2INC looks at a structure definition; if it consists only of bit fields of the same type and if the total size of the bit fields does not exceed the type of the bit fields, then H2INC outputs a **RECORD** definition with the name of the structure. All bit-field names are modified to include the structure name for uniqueness, since record fields have global scope in MASM.

For example,

```
struct s
{
    int i:4;
    int j:4;
    int k:4;
}
```

becomes:

```
s        RECORD @tag_0:4,
          k@s:4,
          j@s:4,
          i@s:4
```

The @tag variable pads the record to the type size of the bit fields so alignment of the structures will be correct.

If the bit fields are too large, are not of the same type, or are mixed with fields that are not bit fields, H2INC generates a **RECORD** definition inside the structure and then uses the definition.

For example,

```
struct t
{
    int i;
    unsigned char a:4;
    int j:9;
    int k:9;
    long l;
} m;
```

becomes:

```
t          STRUCT 2t
i          SWORD  ?
rec@t_0    RECORD  @tag_1:4,
           a@t:4
@bit_0     rec@t_0  <>
rec@t_1     RECORD  @tag_2:7,
           j@t:9
@bit_1     rec@t_1  <>
rec@t_2     RECORD  @tag_3:7,
           k@t:9
@bit_2     rec@t_2  <>
l          SDWORD  ?
t          ENDS
```

```
EXTERNDEF C m:t
```

Notice that *j* and *k* are not packed because their total size exceeds the 16 bits of an integer in *C*.

Since the *@bit* field names are local to the structure, these begin with 0 for each structure type; the *@rec* variables have global scope and so their number always increases.

#### The C bit-field declaration

```
struct SCREENMODE
{
    unsigned int disp_mode : 4;
    unsigned int fg_color  : 3;
    unsigned int bg_color  : 3;
};
```

is converted into the following MASM record:

```
SCREENMODE      RECORD          disp_mode@SCREENMODE:4,
                               fg_color@SCREENMODE:3,
                               bg_color@SCREENMODE:3
```

For information about MASM records, see the *Programmer's Guide*.



## Enumerations

H2INC converts C enumeration declarations into MASM EQU definitions that are treated as standard integer constants. If the C declaration is not assigned a value, then H2INC generates an EQU statement that supplies a value equivalent to its position in the list. For example, the C enumeration declaration

```
enum tagName
{
    id1,
    id2,
    id3 = 42,
    id4
};
```

is converted into the following EQU statements:

```
id1    EQU    0t
id2    EQU    1t
id3    EQU    42t
id4    EQU    43t
```

For information on MASM integer constants, see the *Programmer's Guide*.

## Type Definitions

All type definitions using C base types are translated directly. For example, H2INC converts the C type definitions

```
typedef int  INTEGER;
typedef float FLOAT;
```

to these MASM forms:

```
INTEGER TYPEDEF SWORD
FLOAT   TYPEDEF REAL4
```

Pointer types are converted in a similar fashion. The following declarations

```
typedef int *PINT
typedef int **PINT
typedef int far *PINT
```

become (respectively)

```
PINT TYPEDEF PTR SWORD
PINT TYPEDEF PTR PTR SWORD
PINT TYPEDEF FAR PTR SWORD
```

Addressing mode determines pointer size. The number of bytes allocated for the pointer is set by the addressing mode you have selected unless it is specifically overridden in the type definition. C statements using **typedef** which convert to a type with the same name as the type will generate the warning:

```
HI4010: identifier: identifier is a MASM keyword.
```

and are not converted. For example, H2INC does not convert

```
typedef int SWORD
typedef unsigned char BYTE
```

since these typedef statements would generate these MASM statements:

```
SWORD    TYPEDEF SWORD
BYTE     TYPEDEF BYTE
```

For information on using **TYPEDEF** in MASM 6.1, see the *Programmer's Guide*.

## Converting Function Prototypes

When H2INC converts C function prototypes into MASM function prototypes, the elements of the C syntax are converted into the corresponding elements of the MASM syntax.

The syntax of a C function prototype is

```
[[storage]] [[distance]] [[ret_type]] [[langtype]] label ( [[parmlist]] )
```

In C syntax, *storage* can be **STATIC** or **EXTERN**. H2INC does not translate static function prototypes because static functions are visible only within the current source module, and standard include files do not contain executable code.

In C, the *ret\_type* is the data type of the return value. Because the MASM **PROTO** directive does not specify how to handle return values, H2INC does not translate the return type. However, H2INC checks the *langtype* specified in the C prototype to determine how particular languages return the value—through the stack or through registers.

For the Pascal, FORTRAN, or Basic *langtype* specifications, H2INC appends an additional parameter to the argument list if the return type is longer than 4 bytes. This parameter is always a near pointer with the type of the return value. If the value of the return value type is not supported, this parameter is an untyped near pointer.

For the **\_cdecl** *langtype* specification in the C prototype, all returned data is passed in registers (AX or AX plus DX). There is no restriction on the return type. Additional parameters are not necessary.

The *langtype* represents the naming and passing conventions for a language type. H2INC accepts the following C language types and converts them to their corresponding MASM language types:

C Language Type	MASM Language Type
<code>_cdecl</code>	<code>C</code>
<code>_fortran</code>	<code>FORTTRAN</code>
<code>_pascal</code>	<code>PASCAL</code>
<code>_stdcall</code>	<code>STDCALL</code>
<code>_syscall</code>	<code>SYSCALL</code>

H2INC explicitly includes the *langtype* in every function prototype. If no language type is specified in the .H file prototype, the default language is `_cdecl` (unless the default is overridden by the `/Gc` command-line option).

In the MASM prototype syntax, the *label* is the name of the function or procedure.

If you select the `/Mn` option, H2INC specifies the *distance* of the function (near or far), whether or not the C prototype specifies the distance. If `/Mn` is not set, H2INC specifies the distance only when it is different from the default distance specified by the memory model.

If the C prototype's parameter list ends with a comma plus an ellipsis (`, . . .`), the function can accept a variable number of arguments. H2INC converts this to the MASM form: a comma followed by the `:VARARG` keyword (`, :VARARG`) appended to the last parameter.

H2INC does not translate `_fastcall` functions. Functions explicitly declared `_fastcall` (or invoking H2INC with the `/Gr` option) generate a warning indicating that the function declaration has been ignored.

The following examples show how the preceding rules control the conversion of C prototypes to MASM prototypes (when the memory model default is small). The example function is `my_func`. The `TYPEDDEF` generated by H2INC for the `PROTO` is given along with the `PROTO` statement.

```
/* C prototype */
    my_func (float fNum, unsigned int x);
; MASM TYPEDDEF
    @proto_0 TYPEDDEF PROTO C :REAL4, :WORD
; MASM prototype
    my_func PROTO @proto_0
```

```
/* C prototype */
extern my_func1 (char *argv[]);
; MASM TYPEDEF
    @proto_1 TYPEDEF  PROTO C :PTR PTR SBYTE
; MASM prototype
    my_func1 PROTO    @proto_1
/* C prototype */
    struct vconfig _far * _far pascal my_func2 (int, scri );
; MASM TYPEDEF
    @proto_2 TYPEDEF  PROTO FAR PASCAL :SWORD, :scri
; MASM prototype
    my_func2 PROTO    @proto_2
/* C prototype */
    long pascal my_func3 (double y, struct vconfig vc);
; MASM TYPEDEF
    @proto_3 TYPEDEF  PROTO PASCAL :REAL8, :vconfig
; MASM prototype
    my_func3 PROTO    @proto_3
/* C prototype */
    void _far _cdecl myfunc4 ( char _huge *, short);
; MASM TYPEDEF
    @proto_4 TYPEDEF  PROTO FAR C :FAR PTR SBYTE, :SWORD
; MASM prototype
    myfunc4 PROTO    @proto_4

/* C prototype */
    short my_func5 (void *);
; MASM TYPEDEF
    @proto_5 TYPEDEF  PROTO C :PTR
; MASM prototype
    my_func5 PROTO    @proto_5

/* C prototype */
    char my_func6 (int, ...);
; MASM TYPEDEF
    @proto_6 TYPEDEF  PROTO C :SWORD, :VARARG
; MASM prototype
    my_func6 PROTO    @proto_6

/* C prototype */
    typedef char * ptrchar;
    ptrchar _cdecl my_func7 (char *);
; MASM TYPEDEF
    @proto_7 TYPEDEF  PROTO C :PTR SBYTE
; MASM prototype
    my_func7 PROTO    @proto_7
```

For more information, see the *Programmer's Guide*.

## Summary of H2INC-Recognized Keywords and Pragmas

The four lists below comprise a summary of all the special keywords recognized by H2INC. Items or lists marked with an asterisk (\*) are recognized by H2INC version 1.01 or later.

### C Keywords (Non-Scored)

auto	else	int	static
break	enum	interrupt	struct
case	extern	long	switch
cdecl	far	near	typedef
char	float	pascal	union
const	for	register	unsigned
continue	fortran	return	void
default	goto	short	volatile
do	huge	signed	wchar_t *
double	if	sizeof	while

### C Keywords (Single-Scored) (Double-Scored)

_api	_interrupt	__api	__interrupt
_asm	_loadds	__asm	__loadds
_based	_near	__based	__near
_cdecl	_pascal	__cdecl	__pascal
_export	_saveregs	__export	__saveregs
_far	_segment	__far	__segment
_far16	_segname	__far16	__segname
_fastcall	_self	__fastcall	__self
_fortran	_stdcall	__fortran	__stdcall
_huge	_syscall	__huge	__syscall

### Preprocessor Keywords

define	ifdef
elif	ifndef
else	include
endif	line
error	pragma
ident	undef
if	

## Preprocessor Pragmas

alloc_text	inline_recursion *	plmn
auto_inline *	intrinsic	same_seg
check_pointer	linesize	search_lib
check_stack	loop_opt	segment
code_seg *	message	setlocale *
comment	native_caller *	skip
data_seg	optimize	subtitle
function	pack	switch_check
hdrstop *	page	title
init_seg *	pagesize	vtordisp *
inline_depth *	plmf	warning *

## IMPLIB

This section describes the Microsoft Import Library Manager (IMPLIB) version 1.40. This utility creates an import library from one or more module-definition (.DEF) files and dynamic-link libraries (DLLs) for use in resolving external references from a Windows-based program to a DLL. IMPLIB version 1.40 is designed to use .DEF files and DLLs that work with the Microsoft Segmented-Executable Linker, versions 5.30 and later.

## About Import Libraries

An “import library” is a static library (usually with a .LIB extension) that can be read by the LINK utility. You specify the import library to LINK in the same ways you specify standard libraries created by the LIB utility. You can use LIB to combine an import library with other static libraries, either standard or import. For more information on LINK, see Chapter 13. For more information on LIB, see Chapter 17.

Import libraries are recommended for resolving references from applications to DLLs. Without an import library, an external reference to a dynamic-link routine must be either declared in an **IMPORTS** statement in the application’s .DEF file or explicitly coded in your program.

This section assumes you are familiar with import libraries, dynamic linking, and module-definition files. For information on module-definition files, see Chapter 14. For information on dynamic linking and import libraries, see the *Programmer’s Guide*.

IMPLIB uses only the following statements from a module-definition file and ignores other text in the .DEF file:

- ◆ **LIBRARY**
- ◆ **EXPORTS**
- ◆ **INCLUDE**

## The IMPLIB Command Line

To run IMPLIB, use the following command line:

```
IMPLIB [[options]] implibname {dllfile... | deffile...}
```

The *options* field specifies IMPLIB options, which are explained in the next section.

The *implibname* field specifies the name for the new import library.

The *dllfile* field specifies the name of a DLL. You can use the *deffile* field to specify a module-definition file for the DLL rather than the DLL itself. You can enter multiple *dllfile* and *deffile* specifications. When you specify a DLL, IMPLIB puts all exports from the DLL into the import library. To include only a subset of the DLL's exported items in the import library, specify a module-definition file that contains only those exports.

IMPLIB does not assume default extensions for any field. You must specify the full names of input and output files and include the file extensions. You can specify a path with a filename.

### Example

```
IMPLIB mylib.lib mylib.dll
```

This command creates the import library named MYLIB.LIB from the dynamic-link library MYLIB.DLL.

## Options

Options names are not case sensitive and can be abbreviated to the shortest unique name. IMPLIB has the following options:

**/H[[ELP]]**

Calls the QuickHelp utility. If IMPLIB cannot find the help file or QuickHelp, it displays a brief summary of IMPLIB command-line syntax.

**/NOI[[GNORECASE]]**

Preserves case sensitivity in exported and imported names.

`/NOL[[OGO]]`

Suppresses the IMPLIB copyright message.

`/?`

Displays a brief summary of IMPLIB command-line syntax.

## RM, UNDEL, and EXP

This sections describes the following utilities:

- ◆ Microsoft File Removal Utility (RM) version 2.00
- ◆ Microsoft File Undelete Utility (UNDEL) version 2.00
- ◆ Microsoft File Expunge Utility (EXP) version 2.00

RM, UNDEL, and EXP run under real-mode MS-DOS. You can use these utilities to create hidden backup files, recover the files, and delete them when no longer needed. You can also use them to manage the backup files created by the Microsoft Programmer's WorkBench (PWB).

Be sure to use matching versions of the RM, EXP, and UNDEL utilities. You can check version numbers by running each utility with the `/?` option.

## Overview of the Backup Utilities

The RM, UNDEL, and EXP utilities help you create backup files and manage those files. RM ("remove") moves a file into a hidden subdirectory named DELETED. UNDEL ("undelete") makes the file visible again by moving it into DELETED's parent directory. EXP ("expunge") deletes the DELETED directory and all files contained within; after being expunged, these files cannot be restored by UNDEL.

Use RM, UNDEL, and EXP to manage backup files created by PWB. PWB stores backup files in a DELETED directory when its **Backup** switch is set to **Undel**.

## The RM Utility

The RM utility moves one or more files to a hidden directory named DELETED. DELETED is a subdirectory of the directory that contains the file being deleted. Thus RM may create many DELETED directories on your drives or floppy disks. RM creates a DELETED subdirectory of a given directory if one does not already exist. Run RM using the following command line:

```
RM [[options]] [[files]]
```

The *files* field specifies the files to be deleted. You can name more than one file, and you can use operating-system wildcards (`*` and `?`). You can specify a path with



the filename. RM prompts for permission before removing a read-only file unless /F is specified.

RM has the following options; the option names are not case sensitive:

/F

Deletes read-only files without prompting for permission.

/HELP

Calls the QuickHelp utility. If RM cannot find the help file or QuickHelp, it displays a brief summary of RM command-line syntax.

/I

Inquires for permission before deleting any file.

/K

Keeps read-only files without deleting or prompting.

/R *directory*

Recurse into subdirectories of *directory* and moves all files into corresponding DELETED directories.

/?

Displays a brief summary of RM command-line syntax.

### Example

```
RM /R \PROJECT
```

This command line tells RM to delete all files in the directory tree whose root is the directory named PROJECT. The PROJECT directory lies in the root directory on the current drive. RM moves all files in this tree to hidden directories named DELETED, each of which is created as a subdirectory of a directory that contains the file to be deleted.

## The UNDEL Utility

The utility restores one or more deleted files by moving them from a hidden DELETED subdirectory to the parent directory. Run UNDEL using the following command line:

```
UNDEL [[ { option | files } ]]
```

The *files* field specifies the files to be restored. If you specify more than one file, separate the names with spaces. You cannot use operating-system wildcards (\* and ?). You can specify a path with the filename. If more than one file in DELETED has the specified name, UNDEL lists the versions and prompts for which file to restore. If a file with the same name already exists in the parent directory, UNDEL moves it to the DELETED directory before restoring the specified file.

To list all files in the current directory's DELETED subdirectory, specify the UNDEL command alone. However, you cannot list files in a remote directory; UNDEL does not accept a path without a filename.

UNDEL has the following options; the option names are not case sensitive:

**/HELP**

Calls the QuickHelp utility. If UNDEL cannot find the help file or QuickHelp, it displays a brief summary of UNDEL command-line syntax.

**/?**

Displays a brief summary of UNDEL command-line syntax.

### Example

```
UNDEL \PROJECT\WORK\REPORT.TXT
```

This command line tells UNDEL to restore the file called REPORT.TXT in the directory \PROJECT\WORK on the current drive. If a file called REPORT.TXT already exists in that directory, UNDEL changes the file to a backup file in \PROJECT\WORK\DELETED before restoring REPORT.TXT. If more than one file called REPORT.TXT exists in \PROJECT\WORK\DELETED, UNDEL prompts for which version to restore.

## The EXP Utility

The EXP utility removes a hidden DELETED directory and all files contained within. To run EXP, use the following command line:

```
EXP [options] [directories]
```

The *directories* field specifies one or more directories containing DELETED directories to be expunged. If no directory is specified, EXP deletes the current directory's DELETED subdirectory.

EXP has the following options; the option names are not case sensitive:

**/HELP**

Calls the QuickHelp utility. If EXP cannot find the help file or QuickHelp, it displays a brief summary of EXP command-line syntax.

**/Q**

Suppresses display of the names of deleted files.

**/R**

Recurses into subdirectories of the current or specified directory and expunges all DELETED directories and files.

**/?**

Displays a brief summary of EXP command-line syntax.

### Example

```
EXP /R \PROJECT\WORK
```

This command line tells EXP to:

- ◆ Delete the hidden directory \PROJECT\WORK\DELETED along with any files in the directory.
- ◆ Recurse through the tree whose root is \PROJECT\WORK and delete any DELETED directories and associated files.

## WX/WXServer

This section describes the Microsoft WX/WXServer Utility version 1.50. This utility runs a Windows-based program from an MS-DOS prompt within the Windows operating system. The utility has two parts:

- ◆ WX.EXE is a command-line utility that runs a Windows-based application from an MS-DOS prompt either in a full screen or in a window.
- ◆ WXSrvr.EXE is a Windows-based program that must be running when you use WX.

Microsoft Programmer's WorkBench (PWB) uses WXServer to run your Windows-based programs and Microsoft CodeView for the Windows operating system.

## Running WX/WXServer

WX/WXServer requires the Windows operating system 386 enhanced mode. The [386Enh] section of SYSTEM.INI must contain the following line:

```
device=[path\]vmb.386
```

To use WX/WXServer, you start WXSrvr.EXE once and leave it running in the Windows operating system. You then can run a Windows-based application in an MS-DOS session, either in a window or full screen, by running WX.EXE.

### Running WXSrvr.EXE

To run WXSrvr.EXE, start it as an application in the Windows operating system using one of the following methods:

- ◆ In the File Manager window, double-click the WXSrvr.EXE file (or select it and press ENTER).
- ◆ From the File menu in either the Program Manager or File Manager window, choose the Run command and type WXSrvr in the Command Line box.

- ◆ In the Program Manager window, double-click the WXServer icon. If you added the MASM.GRP to your windows desktop, the WXServer icon will be there. (For information on adding the MASM.GRP to your windows desktop, see *Getting Started*.)

When WXSrvr.EXE is running, it does not come up in a window or full screen. The only features you can see are the WXServer icon on the desktop and the About Microsoft WXServer dialog box. The About dialog box is displayed if WXSrvr.EXE is running and you do one of the following:

- ◆ Open the Control menu for WXServer and choose About WXServer.
- ◆ Switch to WXServer.
- ◆ Double-click the WXServer icon on the desktop.

The About dialog box contains four command buttons, described below:

Button Label	Action
OK	Accepts changes to the Timer Delay setting
Cancel	Closes the dialog box and ignores any changes
Hide	Removes the icon from the desktop and leaves WXServer running
Terminate	Closes WXServer

The dialog box also contains a box labeled Timer Delay. The setting in this box determines how often WXServer checks for requests by WX to run a program. The default setting of 100 milliseconds is appropriate for most situations. You can try increasing the timer delay if your system seems to be running too slowly. You can decrease the timer delay to get a quicker response to the WX command.

If you want to hide the WXServer icon, you can do so in one of two ways:

- ◆ Run WXSrvr.EXE using the /H option, as in the following command:

```
wxsrvr /h
```

- ◆ Open the About dialog box and choose Hide.

To restore the WXServer icon to the desktop, start WXSrvr.EXE again.

To end WXSrvr.EXE, do one of the following:

- ◆ From the Control menu for WXServer, choose Close.
- ◆ Open the About dialog box and choose Terminate.

## Running WX

To run WX, open an MS-DOS session and enter the following command at the MS-DOS prompt:

```
WX [[options]] program [[arguments...]]
```

The *program* is the filename of the Windows-based application you want to run. The *arguments* are any command-line options, filenames, or other arguments required to run your application. Specify *options* to WX before specifying the program name. Options names are not case sensitive and can be abbreviated to the shortest unique name. WX has the following options:

**/A**[[SYNC]]

Runs the program asynchronously. By default, WX runs synchronously, which pauses the MS-DOS session until the program ends. The /A option lets other programs run in the same MS-DOS session while the Windows-based program is running.

When running synchronously, WX requires that the MS-DOS prompt run in the background. (To do this, open the Control menu for the MS-DOS prompt and choose the Settings command, then turn on the Background option under Tasking Options.)

WXServer can run only one program synchronously, but it can run additional programs asynchronously.

**/B**[[ATCH]]

Suppresses dialog messages if errors occur. This option is useful for batch processing.

**/H**[[ELP]]

Displays a brief summary of WX command-line syntax.

**/N**[[OLOGO]]

Suppresses the WX copyright message.

**/W**[[INDOW]]

Runs a program from an MS-DOS prompt that is in a window rather than full screen.

**/?**

Displays a brief summary of WX command-line syntax.

### Example

The following command uses WX to run an application in a window without the copyright display:

```
wx /w /nologo project
```

### The WX Environment Variable

WX.EXE uses the environment variable WX if the variable has been set. For example, if you always want to run WX in a window without the copyright display, use the following command to set the environment variable:

```
SET WX=/W /NOLOGO
```

After the WX environment variable is set, use the following command to run the application:

```
wx project
```

P A R T 5

# Using Help

Chapter 21 Using Help.....663





## CHAPTER 21

## Using Help

MASM offers two systems for accessing Help:

- ◆ The Microsoft Advisor, found within the Programmer's WorkBench (PWB) and CodeView
- ◆ QuickHelp, the standalone Help program

Both systems provide the same information on important topics and utilities provided with the development system, which include the language, run-time libraries, PWB, and CodeView.

### Structure of the Microsoft Advisor

The Microsoft Advisor can be compared to a librarian managing a collection of books. Each book, or Help file, has its own table of contents, index, and pages of information. The Advisor organizes the Help files with a global contents and index. All of the files are listed, and their specific tables of contents and indexes can be accessed through the global references. The global contents screen is shown in Figure 21.1.

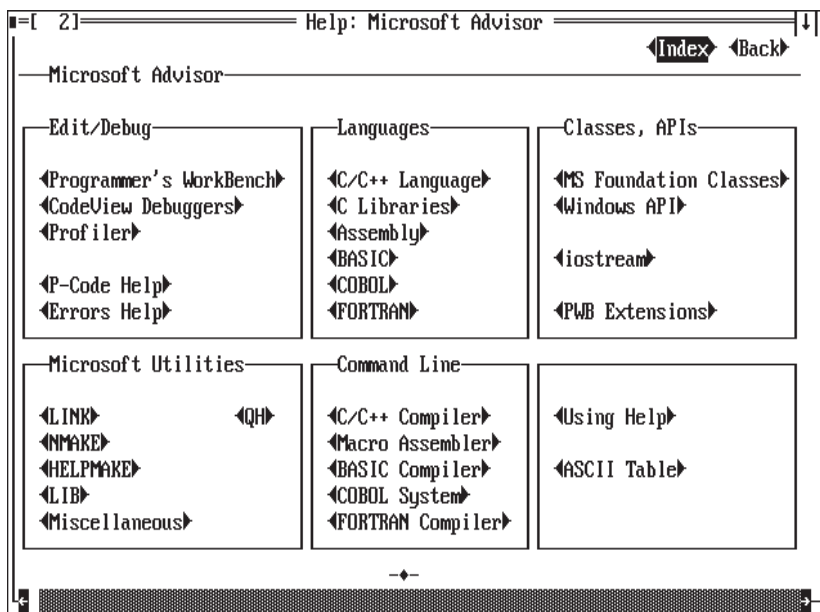

**Figure 21.1** Microsoft Advisor Global Contents Screen

You can access a variety of information from the Help system. Information is available on the languages, run-time libraries, errors, and the Help system itself.

## Navigating Through the Microsoft Advisor

You request information about a topic in a window by moving the cursor to it and pressing F1 or by clicking it with the right mouse button. The Help system then searches through the Help files for information about the topic. If it finds the topic, the Help system displays information in the Help window. If Help cannot be found for a particular word or symbol, a message informs you that no information is associated with the topic.

Sometimes, a topic with the same name occurs in several Help files. When you request Help in PWB for one of these names, PWB displays a dialog box in which you can select the context of the topic. The Next command on the Help menu takes you to the next occurrence. When you are using QuickHelp, the first topic is displayed. You can then press E to go to the next occurrence.

---

**Note** CodeView does not use the right mouse button for Help in the Source window. Clicking the right mouse button on a line in the Source window executes the program to that line. However, the right mouse button activates Help in the other CodeView windows.

---

## Using the Help Menu

The simplest method for accessing Help is by using the commands found in the PWB and CodeView Help menus. These commands present information in the Help window.

Command	Description
Index	Displays the global index of categories (see Figure 21.2).
Contents	Displays the global Help contents screen.
Topic: <i>topic</i>	Provides information about the topic at the cursor. If information about the topic is available, the topic's name is appended to the Topic command. Otherwise, this command is dimmed.
Help on Help	Displays information about using Help itself.

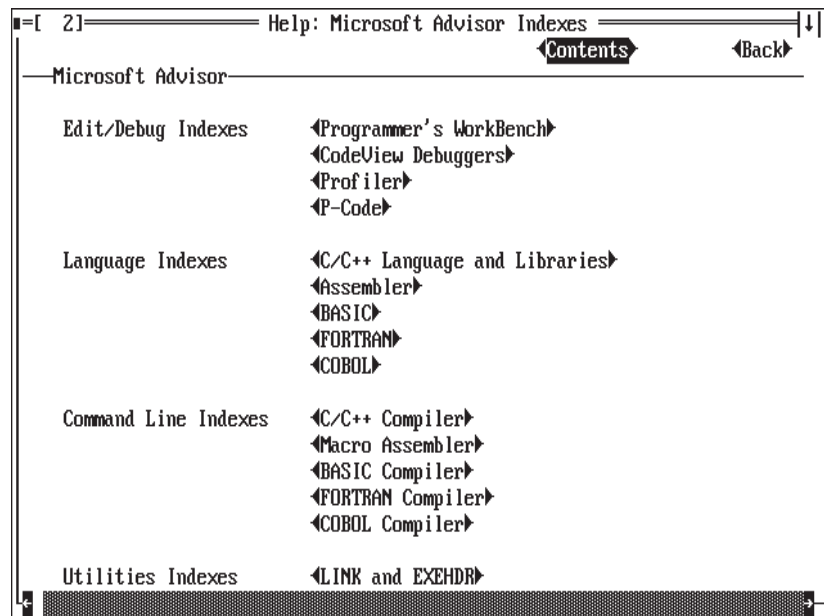

**Figure 21.2** Microsoft Advisor Global Index Screen

PWB and QuickHelp provide additional commands to access Help. These commands are described in the program-specific sections at the end of this chapter.

## Using the Mouse and the F1 Key

You can use the mouse and the F1 key to get information about any menu command or dialog box, as well as information on keywords, operators, and run-time library functions.

## Help on Menu Commands

→ **To view information about a menu item:**

1. Open the menu.
2. Drag the mouse to the command and click the right mouse button.  
-or-  
Use the ARROW keys to select the command and press F1.

The information on the selected command is displayed in a Help dialog box.

## Help on Dialog Boxes

→ **To view information about a dialog box:**

1. Open the dialog box.
2. Click the Help button.  
-or-  
Press F1.

The information on the dialog box is displayed in a Help dialog box.

## Using Hyperlinks

Hyperlinks are cross-references that connect related information.

Hyperlinks enclosed by the < and > characters are called “buttons.” You can navigate through the Help system by using these buttons.

You can press TAB to move to the next hyperlink button within the Help window. Pressing SHIFT+TAB moves to the previous button. In PWB and CodeView, typing any letter moves the cursor to the next button that begins with that letter; holding down SHIFT and typing a letter moves the cursor backward.

The Microsoft Advisor also recognizes language keywords, library functions, constants, and similar identifiers as hyperlinks, but these are not marked. Unmarked hyperlinks are recognized by the Microsoft Advisor wherever they appear in the Help text or *in your source code*. However, an unmarked hyperlink is not delimited with the < and > characters, and you can't move to it with the TAB key.

An unmarked hyperlink can be activated only by pointing to it with the mouse and clicking the right mouse button or by placing the cursor on it and pressing F1. In QuickHelp, press the S key and then type the text of the hyperlink in the dialog box. In CodeView, use the Help (**H**) Command-window command.

- **To activate a hyperlink with the mouse:**
1. Move the mouse pointer to the hyperlink.
  2. Click the right mouse button.
- or-
- Click the left mouse button twice (double-click). Double-clicking works only in the Help window.
- **To activate a hyperlink with the keyboard:**
1. Press TAB, SHIFT+TAB, or the ARROW keys to move the cursor to the hyperlink. When you move the cursor to a hyperlink button, the entire button is selected.
  2. Press F1, ENTER, or SPACEBAR.

Any of these actions displays information about the topic at the cursor. If the topic isn't a hyperlink, a message informs you that no information on the topic could be found.

---

**Note** CodeView uses the right mouse button differently in the Source window. Clicking the right button in the Source window executes the program to the line where the mouse was clicked. However, once the Help window is displayed, the right mouse button can be used to activate hyperlinks.

---

## Using Help Windows and Dialog Boxes

The Microsoft Advisor displays information in windows or dialog boxes. Help windows and dialog boxes function in the same way as other windows and dialog boxes found in PWB and CodeView. For a complete description of windows and dialog boxes, see Chapter 4, "User Interface Details."

### Using the Help Window

The Help window displays various contents, indexes, and information about selected topics. Some screens of information are larger than the Help window; information beyond the window borders can be viewed by using the scroll bars or the cursor-movement keys. The **-◆-** symbol indicates the end of information in the Help window.

## Navigating with Hyperlinks

At the top of most Help windows is a row of hyperlink buttons that are useful for moving through the Help system:

Button	Description
<Up>	Moves upward in the hierarchy of Help screens. Since information is ordered in a logical way, moving from the general to the specific, this command is useful for moving up the information tree.
<Contents>	Displays the global contents screen. This command is useful because it returns you to a known point in the Help hierarchy. For some Help databases, the Contents button goes to that database's contents.
<Index>	Displays the global index list. Selecting an item from the list displays the index for that category. When you are viewing an index for a particular category, the letters on the bar across the top of the screen are hyperlinks. For some Help databases, the Index button goes to that database's index.
<Back>	Moves you to the last Help you saw.

The Contents and Index commands on the Help menu always display the global Contents and Index screens.

Screens on a particular topic are frequently grouped together in a Help file. You can press CTRL+F1 to display information about the next physical topic in the Help file.

## Viewing the Previous Help

The Microsoft Advisor remembers the last 20 Help screens you've accessed. To return to a previous screen, use the <Back> button or press ALT+F1 as many times as necessary to return to the screen you want to see. The Help screen that appears is active; you can ask for Help on any of its hyperlinks or topics.

You can always return to the global Contents screen by choosing Contents from the Help menu or by pressing SHIFT+F1.

## Copying and Pasting Help

Any text that appears in the PWB Help window can easily be copied to another window. For example, to test an example program from the Help window, you only have to copy it to a new file and compile it. You select and copy text in the Help window just as you do for any other window in PWB.

If you are using QuickHelp, you cannot cut and paste directly into your text editor. However, you can use the commands in the QuickHelp Paste menu to extract predetermined portions of the Help screen to a file. To change the name of the paste file, choose Rename Paste File from the File menu.

If you paste example code from QuickHelp, you will need to delete the “Topic” line at the beginning and the -◆- line at the bottom of the topic before you can successfully assemble or compile the example.

### Closing the Help Window

Once you’re through working with the Help system, you can close the active Help window.

- ➔ **To close the Help window:**
  - Choose the Close button in the upper left corner of the window.
  - or-
  - Press ESC.

### Using Help Dialog Boxes

Help dialog boxes provide information about menu commands and dialog boxes. A Help dialog box appears over the windows on the desktop. Unlike the Help window, a Help dialog box must be closed before you can continue. The Cancel button closes the Help dialog box.

- ➔ **To view information about a dialog box:**
  - Choose the Help button in the dialog box.
  - or-
  - Press F1.
- ➔ **To close a Help dialog box:**
  - Choose the Cancel button.
  - or-
  - Press ESC.

## Accessing Different Types of Information

This section presents some strategies for accessing the different types of information available within the Help system.

### Keyword Information

The Help system contains information about all keywords, operators, symbolic constants, and library functions in the development system. If you know the exact name of a keyword, you can type it in a window and click it with the right mouse button or press F1. For operators that do not have an alphabetic name, you must select the operator before activating Help. You can also use the index for the appropriate category of Help.

➔ **To get Help using the index:**

1. From the Help menu, choose Index.  
-or-  
Choose the Index button on any Help screen.
2. Choose the appropriate category of Help from the list of indexes.  
Each index has a row of letters across the top.
3. Choose the keyword's first letter from the row of letters. If you want Help for a nonalphabetic operator, choose the asterisk (\*).
4. Scroll down the list of entries and choose the topic's hyperlink.

In PWB, you can get Help on a keyword or operator by using the **Arg** function, typing the keyword in the Text Argument dialog box, then pressing F1. Assuming that **Arg** is assigned to ALT+A (the default assignment), the following procedure displays Help for the **mov** function.

➔ **To get Help using the Arg function in PWB:**

1. Press ALT+A  
PWB displays the message `Arg [1]` on the status bar.
2. Type `mov`.  
When you type the first letter of the keyword, PWB displays the Text Argument dialog box. Continue typing the keyword.
3. Press F1.  
PWB displays the Help for the **mov** function.

➔ **To get Help on a topic in QuickHelp:**

1. Choose Search from the View menu or press the S key.  
QuickHelp displays a dialog box where you can type the topic name.
2. Type the keyword.
3. Choose OK or press ENTER.

Figure 21.3 shows a PWB window with the information for the **mov** function.



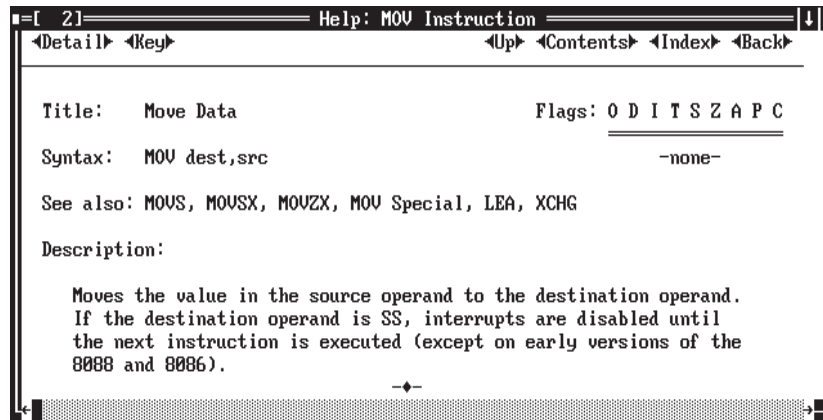

**Figure 21.3** Help for mov in a PWB Window

When information about a programming-language keyword or function is shown in the Help window, two additional hyperlink buttons are displayed.

#### <Description>

Provides a detailed explanation of the function. When the description information is displayed, the button changes to <Summary>. Click this button to return to the summarized information about the function.

#### <Example>

Displays source code that provides an example of how the function is used.

## Topical Information

The Help system is useful when you want an overview of the available reference topics or when you only have a general idea of what information you need. Start with the global contents screen, and then select any hyperlinks that relate to the topic. You can traverse the hyperlinks until you locate the necessary information.

## Menu and Dialog-Box Help

You can get information about any menu command or dialog box by pressing F1 when the menu command is highlighted or the dialog box is displayed. This is helpful when you are first learning to use the development system and you are not completely familiar with all of the features.

## Error Help

The Microsoft Advisor provides information about compiler and linker error messages. Whenever a message is displayed on the bottom line of the window in PWB, press F1 to see Help on that error.

You can also get Help for any error in the Build Results window.

- **To find the meaning of an error message using the mouse:**
  1. Position the mouse pointer on the error number in the Build Results window.
  2. Click the right mouse button.
  
- **To find the meaning of an error message using the keyboard:**
  1. Move the cursor to the Build Results window.
  2. Position the cursor on the error number.
  3. Press F1.

Help on error messages is also available directly by executing the **Arg** function, typing the error number and its alphabetic prefix, and then pressing F1. Make sure that you type the number exactly—case is significant.

## Using Different Help Screens

In addition to the global screens and the topic screens that have already been described in this chapter, the Microsoft Advisor contains some other types of screens that you use in special ways.

### Using Index Screens

An index screen has a bar of letters at the top of the screen, below the row of hyperlink buttons. Each letter on the bar is a hyperlink to that letter's list of index entries. The asterisk (\*) at the end of the bar is also a hyperlink. This screen lists the nonalphabetic entries. Click the right mouse button on the letter to see that part of the index.

Figure 21.4 shows the PWB index screen for the A category. Below the row of alphabet hyperlinks is a list of index entries. Each entry is a hyperlink to the indicated topic.

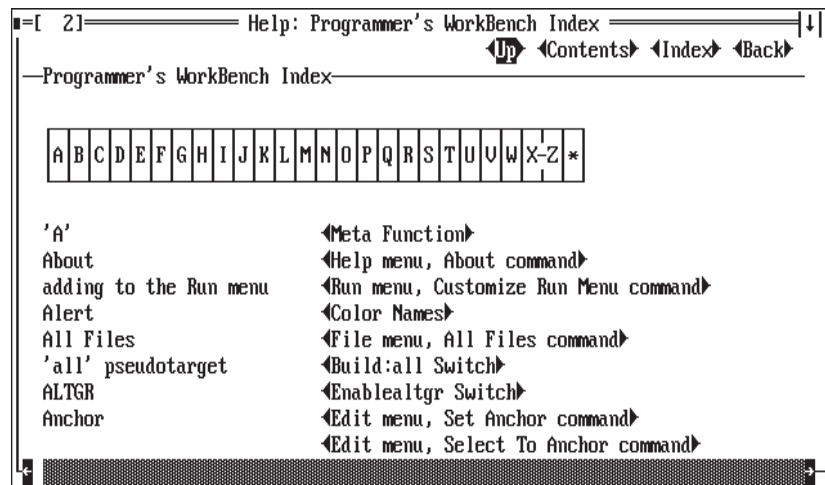

Figure 21.4 PWB Index

## Using Topic Lists

Some topics are not a screen of text with fixed hyperlink buttons at the top. Instead, they are a list of topics in which each line is a hyperlink. The entire line is highlighted. You can point to the line and click the right mouse button to activate the hyperlink. You can also use the UP ARROW and DOWN ARROW keys to select a topic, and then press F1 or ENTER to go to that topic.

## Using Help in PWB

PWB provides additional Help features to help you find the information you need.

### Opening a Help File

You can open Help files temporarily in PWB by using the **SetHelp** function. If you keep rarely used Help files in a directory that is not listed in the HELPFILES environment variable, you can still open the files when you need them.

➔ **To open another Help file in PWB:**

1. Execute the **Arg** function (press ALT+A).
2. Type the name of the Help file to open. PWB displays the Text Argument dialog box when you type the first letter of the filename.
3. Execute the **SetHelp** function (press SHIFT+CTRL+S).

To close a Help file, execute **Arg Meta file SetHelp**. That is, press ALT+A, F9, type the filename, then press SHIFT+CTRL+S.

## Global Search

The Global Search command on the Help menu in PWB lets you search all open Help files for a string of text or a regular expression. All text in the Help files is searched, not just the topic names. A global search results in a list of topics, each of which contains text that matches the search string. QuickHelp can also perform global Help searches, but does not offer regular-expression matching.

Searching all the Help can take a long time. Therefore, it is recommended that you use the Global Search command only after you have tried other methods of finding the information you need.

### Running a Global Search

When you choose the Global Search command, PWB displays the Global Search dialog box where you can specify options for the search. Enter the string or pattern you want to locate in the Find Text box. If you want the search to be case sensitive, turn on the Match Case option. To match a regular expression rather than literal text, turn on the Regular Expression option.

Regular expressions allow you to specify general patterns of text or several alternative strings to match. The current regular-expression syntax is displayed in parentheses after the Regular Expression option. For more information about searching with regular expressions, see Chapter 5, "Advanced PWB Techniques," and Appendix B.

When you choose OK, PWB starts searching for the specified string or regular expression. The search begins with the Help file that was opened most recently. Because the search can take a long time, it is recommended that you choose a likely category of Help from the global Contents screen before starting a global search.

When you start a global search, PWB displays a dialog box that shows the progress of the search. Choose the Stop Search button at any time to stop the search and view the partial results. When the search ends, PWB displays a list of matching topics.

### Using Search Results

When the search is finished, or when you halt the search by choosing Stop Search, PWB displays a list of the topics that contain text that matches the specified string. Each topic is represented by its title if it has one, followed by the name of the database that contains the topic, and sometimes followed by the topic name.

→ **To select a topic from the list:**

- Click the right mouse button on the line.
- or-
- Press the UP ARROW and DOWN ARROW keys until the topic is highlighted, and then press ENTER or F1.

PWB displays the selected topic. If that topic does not supply the information that you need, go back to the list and select another topic.

→ **To go back to the list:**

- Choose Search Results from the Help menu.
- or-
- Press ALT+F1 until the list is displayed.

## Restricting the Search

By default, PWB performs a global search in all open databases. There are several ways to control which databases are searched:

- ◆ Before the search, display Help from the database that is most likely to contain the information you want. When you run the search, choose Stop Search when the dialog box indicates that the first database has been searched.
  - ◆ Close some databases by using the **Meta** form of the **SetHelp** function.
  - ◆ Set the HELPFILES environment variable to the file or files to be searched by using the Environment Variables command on the Options menu. The list of files cannot exceed the MS-DOS limit of 128 characters.
- Note that the changes you make to HELPFILES may be restored the next time you start PWB or use the project, depending on the settings of the **Envcursave** and **Envprojsave** switches.
- ◆ Choose the Editor Settings command from the Options menu. Then select PWBHELP as the Switch Owner and Text as the switch type. Assign a value to the **Helpfiles** switch to open other Help files in addition to the ones listed in the HELPFILES environment variable.

To see a list of all open Help files and databases, execute the **Arg ? SetHelp** command. The default keystrokes for this are ALT+A, ?, SHIFT+CTRL+S. The resulting list of physical Help files and Help databases is displayed in the Help window.

## Using QuickHelp

QuickHelp is a separate application that provides access to any Help file. It uses the same Help files as the Microsoft Advisor and presents information about topics in the same way. QuickHelp is designed for the developer who prefers using

command-line utilities or another editor and doesn't have access to the Microsoft Advisor through PWB.

Major utilities that come with MASM invoke QuickHelp and display related information when you use the /Help option. You can also use QuickHelp from the command line, as explained in the following sections.

## Using the /Help Option

You can get immediate information on the major MASM components by using the /Help option. The following procedures use the LIB utility as an example. However, you can use these methods for all command-line utilities in the development system.

➔ **To learn about the LIB utility:**

- At the operating-system command line, type:

```
LIB /Help
```

LIB starts QuickHelp which displays information about LIB.

## Using the QH Command

You can also run QuickHelp from the MS-DOS command line or by double-clicking the MASM 6.1 Reference icon in your Windows operating system Program Manager MASM group. (For more information on adding the MASM.GRP program group to your windows desktop, see *Getting Started*.)

➔ **To get Help on the LIB utility:**

- At the operating-system command line, type:

```
QH LIB.EXE
```

You can type the name of any Microsoft utility instead of LIB.

➔ **To start QuickHelp to view the Advisor Contents screen:**

- At the operating-system command line, type:

```
QH Advisor
```

In addition to information about programs, QuickHelp can also display information about compiler and run-time errors. Type QH and the error number with its alphabetic prefix on the command line.

## Opening and Closing Help Files

When you run QuickHelp, it looks for the environment variable HELPFILES and opens all listed .HLP files. If the HELPFILES variable isn't defined, QuickHelp opens all .HLP files in directories specified by the PATH environment variable.

---

**Warning** Windows-based Help files are not compatible with QuickHelp. Make sure that Windows-based Help files are not listed in the HELPFILES environment variable.

---

Choose the List Database command on the File menu to view a list of all the open Help files.

→ **To open additional Help files:**

1. Choose the Open Database command from the File menu.
2. Type the name of the Help file to be opened in the dialog box that appears. You can specify all Help files in a directory by typing \*.HLP.
3. Press ENTER or choose the OK button.

→ **To close an open Help file:**

1. Choose the Close Database command from the File menu.  
The File menu changes to a list of open Help files.
2. Choose the Help file to close.

## Displaying a Topic

You can view information about a topic by using the Search command on the View menu. When topic information is displayed, it is shown in the same format as information presented by the Microsoft Advisor.

→ **To display a topic from any of the open Help files:**

1. Choose the Search command from the View menu.
2. Type the topic you want information about in the dialog box.
3. Click the OK button or press ENTER.

QuickHelp searches for the topic in the open Help files. If the topic cannot be found, a dialog box informs you that the search failed. If the search is successful, information about the topic is displayed in the QuickHelp window.

## Navigating Through Topics

A series of commands on the View menu allow you to display selected topics. These commands include the following:

Command	Description
View History	Displays a list of all the topics that have recently been displayed. See “Using Topic Lists” on page 673 for information on using the list.
View Last	Displays the last topic you looked at.
View Next	Displays the next topic in the Help file.
View Back	Moves backward one topic in the Help file.

## Using the QuickHelp Window

The QuickHelp window shown in Figure 21.5 is similar to the Microsoft Advisor Help window. Information that doesn't fully fit in a window can be scrolled, and hyperlinks are used to display additional information. The main difference is that information presented in QuickHelp cannot be copied selectively.

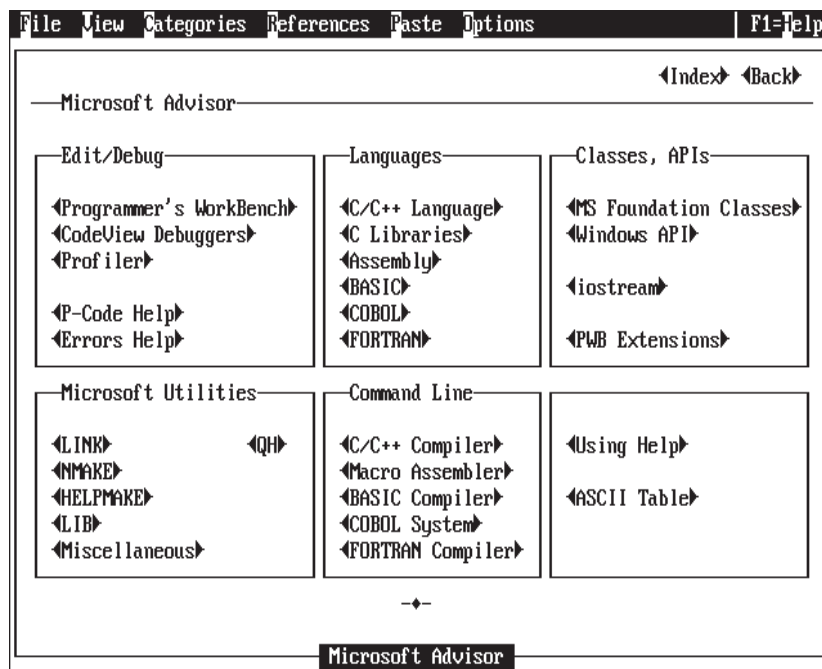

Figure 21.5 The QuickHelp Window



## Copying and Pasting in QuickHelp

To transfer information from QuickHelp to another program, specify a file with the Rename Paste File command in the File menu. Once the file is specified, choose the Current Window or the Current Topic command in the Paste menu to transfer the text to that file. Be sure to specify a new file when you paste because QuickHelp overwrites the existing file by default. To append to an existing file, choose the Paste Mode command from the Options menu. The default filename is PASTE.QH in the directory specified by the TMP environment variable.

## More About QuickHelp

In addition to the features mentioned previously, QuickHelp has a variety of other options such as changing the appearance of the Help window, searching for text within topics, and controlling the function of the right mouse button.

➔ **To learn more about QuickHelp's features:**

1. Make sure the QH.HLP file is open.
2. To view QuickHelp's Help, press F1.

-or-

To get information about a menu command, click it with the right mouse button, or highlight the command and press F1.

## Managing Help Files

When you run the MASM Version 6.10 SETUP program, you are given a choice of whether to install the Help files. If you choose to install Help, SETUP copies the Help files to the directory that you specify. By default, this is the C:\MASMHlp directory.

Several other Microsoft products contain a Microsoft Advisor Help system. If you have more than one of these products, you can use all the files as one system by copying all .HLP files to a common directory. However, make sure that Windows-based Help files are separate from the Advisor Help files.

Some Help files, such as UTILS.HLP, exist in other Microsoft language products. When an existing Help file has the same filename as a MASM Help file, use the most recent file. Note that the files RC.HLP and UTILERR.HLP are obsolete and should be deleted or moved to another directory.

The HELPFILES environment variable tells the Advisor where to find Help files. You usually set this variable in AUTOEXEC.BAT. If you move the Help files, make sure to change the SET command in AUTOEXEC.BAT to point HELPFILES to the new location.

## Managing Many Help Files

If you have a large number of Help files, you may reach a limit on the number of physical Help files or Help databases that can be open at one time. QuickHelp, PWB, and CodeView display a message when you have too many Help files. If this is the case, you must do one or more of the following:

- ◆ Delete all obsolete Help files.
- ◆ Move rarely used Help files to another directory. You can then open these files as you need them.
- ◆ Concatenate some Help files.

It is recommended that you always keep ADVISOR.HLP. Moreover, for Help on error messages, you must use the Help file for the tool that issues the error. It is recommended that you save backup copies of all Help files before concatenating, splitting, or deleting any files.

To open and close Help files in PWB, use the **SetHelp** function. To open and close Help files in QuickHelp, choose the Open Database and Close Database commands from the File menu.

You can get a listing of the open Help files in PWB and QuickHelp. These lists show the open Help files, the Help databases contained in the files, and the title for each database if it has one. To get a list of open Help files in PWB, execute the function sequence **Arg ? SetHelp**. With the default keystrokes, press ALT+A, type a question mark (?), then press SHIFT+CTRL+S. To get a list of open Help files in QuickHelp, choose the List Databases command from the File menu. Once you have created the list of Help files, you can print it for later reference.

## Concatenating Help Files

To concatenate two or more physical Help files, use the MS-DOS COPY command. (Before you concatenate a Help file, save a backup copy of the files you are going to concatenate.) The syntax for using the COPY command to combine Help files is:

**COPY** *file /b* [[+ *file /b*]]... *newfile*

Use a plus sign (+) between the filenames of the original Help files. Specify the /b option to copy the files as binary files. If you don't specify a new filename, the resulting file takes the name of the first file and the original file is overwritten.

You can use this command to combine two Microsoft Advisor Help files. For example, to create a physical Help file named ADVISOR.HLP that contains ADVISOR.HLP and QH.HLP, use the following command:

```
COPY ADVISOR.HLP /b + QH.HLP /b
```

You can also combine your own Help file (created using HELPMAKE) with Microsoft Help files.

## Splitting Help Files

To split a physical Help file into its component databases, use the HELPMAKE utility. (Before you split a Help file, save a backup copy of the file you are going to split.) The syntax for using HELPMAKE to split a Help file is:

### **HELMAKE /DS *file***

Specify the /DS option when splitting a Help file. For more information on the /DS option, as well as other uses of HELPMAKE, see Chapter 18. HELPMAKE creates individual physical files with the name of the original Help database. The resulting files are created in the current directory.

For example, the following command extracts the component Help databases from the UTILS.HLP file:

```
HELMAKE /DS UTILS.HLP
```

The UTILS.HLP file itself is not changed. You can delete the unneeded component files and then concatenate the remaining files to create a new version of UTILS.HLP.



# Appendixes

Appendix A	Error Messages .....	685
Appendix B	Regular Expressions .....	845



## A P P E N D I X A

## Error Messages

The error messages generated by MASM components fall into three categories:

- ◆ Fatal errors. These indicate a severe problem that prevents the utility from completing its normal process.
- ◆ Nonfatal errors. The utility may complete its process. If it does, its result is not likely to be the one you want.
- ◆ Warnings. These messages indicate conditions that may prevent you from getting the results you want.

All error messages take the form:

```
Utility: Filename (Line) : [Error type] (Code): Message text
```

*Utility* is the program that sent the error message.

*Filename* is the file that contains the error-generating condition.

*Line* is the approximate line where the error condition exists.

*Error type* is Fatal Error, Error, or Warning.

*Code* is the unique 5- or 6-digit error code.

*Message text* is a short and general description of the error condition.

## Error Message Lists

Messages for each utility are listed below in numerical order, with a brief explanation of each error. The following two tables list the messages by utility and error code, respectively.

**Table A.1 Error Codes Listed by Utility**

<b>Utility Name</b>	<b>Error Type</b>	<b>Code</b>	<b>Page</b>
BSCMAKE	Fatal	BK1500 to BK1515	688
	Warnings	BK4500 to BK4503	691
C/C++ Expression Evaluators	All	CAN0000 to CAN0063; CXX0000, CXX0064	692
CodeView	Nonfatal	CV0000 to CV5014	700
CVPACK	Fatal	CK1000 to CK1021	716
	Warnings	CK4000 to CK4003	720
EXEHDR	Fatal	U1100 to U1140	721
Math Coprocessor	All	M6101 to M6205	722
H2INC	Fatal	HI1003 to HI1801	724
	Nonfatal	HI2000 to HI2555	727
	Warnings	HI4000 to HI4820	745
HELPMAKE	Fatal	H1000 to H1990	761
	Nonfatal	H2000 to H2003	766
	Warnings	H4000 to H4003	766
IMPLIB	Fatal	IM1600 to IM1608	767
	Nonfatal	IM2601 to IM2603	768
	Warnings	IM4600 and IM4601	768
LIB	Fatal	U1150 to U1203	769
	Nonfatal	U2152 to U2159	772
	Warnings	U4150 to U4158	773
LINK	Fatal	L1001 to L1129	775
	Nonfatal	L2000 to L2064	786
	Warnings	L4000 to L4086	791
ML	Fatal	A1000 to A1901	798
	Nonfatal	A2000 to A2901	802
	Warnings	A4000 to A6005	825
NMAKE	Fatal	U1000 to U1099; U1450 to U1455	828
	Nonfatal	U2001	838
	Warnings	U4001 to U4009	838
PWB	All	PWB3089 TO PWB3912; PWB12078 TO PWB12086	840
SBRPACK	All	SB1000 to SB1006	842



**Table A.2 Error Codes Listed by Error Code Range**

Code	Utility Name	Error Type	Page
A1000 to A1901	ML	Fatal	798
A2000 to A2901	ML	Nonfatal	802
A4000 to A6005	ML	Warnings	825
BK1500 to BK1515	BSCMAKE	Fatal	688
BK4500 to BK4503	BSCMAKE	Warnings	691
CAN0000 to CAN0063; CXX0000, CXX0064	C/C++ Expression Evaluators	All	692
CK1000 to CK1021	CVPACK	Fatal	716
CK4000 to CK4003	CVPACK	Warnings	720
CV0000 to CV5014	CodeView	Nonfatal	700
H1000 to H1990	HELPMAKE	Fatal	761
H2000 to H2003	HELPMAKE	Nonfatal	766
H4000 to H4003	HELPMAKE	Warnings	766
HI1003 to HI1801	H2INC	Fatal	724
HI2000 to HI2555	H2INC	Nonfatal	727
HI4000 to HI4820	H2INC	Warnings	745
IM1600 to IM1608	IMPLIB	Fatal	767
IM2600 to IM2603	IMPLIB	Nonfatal	768
IM4600 and IM4601	IMPLIB	Warnings	768
L1001 to L1129	LINK	Fatal	775
L2000 to L2064	LINK	Nonfatal	786
L4000 to L4086	LINK	Warnings	791
M6101 to M6205	Math Coprocessor	All	722
PWB3089 to PWB3912; PWB12078 to PWB12086	PWB	All	840
SB1000 to SB1006	SBRPACK	All	842
U1000 to U1099	NMAKE	Fatal	828
U1100 to U1140	EXEHDR	Fatal	721
U1150 to U1203	LIB	Fatal	769
U1450 to U1455	NMAKE	Fatal	828
U2001	NMAKE	Nonfatal	838
U2152 to U2159	LIB	Nonfatal	772
U4001 to U4009	NMAKE	Warnings	838
U4150 to U4158	LIB	Warnings	773

## BSCMAKE Error Messages

Microsoft Browser Database Maintenance Utility (BSCMAKE) generates the following error messages:

- ◆ Fatal errors (BK1xxx) cause BSCMAKE to stop execution.
- ◆ Warnings (BK4xxx) indicate possible problems in the database-building process.

## BSCMAKE Fatal Error Messages

### **BK1500 UNKNOWN ERROR**

**Contact Microsoft Product Support Services**

BSCMAKE detected an unknown error condition.

Note the circumstances of the error and notify Microsoft Corporation by following the instructions in the “Microsoft Support Services” section of the introduction to this book.

### **BK1501 unknown character *character* in option *option***

BSCMAKE did not recognize the given character specified for the given option.

### **BK1502 incomplete specification for option *option***

The given option did not contain the correct syntax.

### **BK1503 cannot write to file *filename***

BSCMAKE could not write to the given file.

One of the following may have occurred:

- ◆ The disk was full.
- ◆ A hardware error occurred.

### **BK1504 cannot position in file *filename***

BSCMAKE could not move to a location in the given file.

One of the following may have occurred:

- ◆ The disk was full.
- ◆ A hardware error occurred.
- ◆ The file was truncated. Truncation can occur if the compiler runs out of disk space or is interrupted when it is creating the .SBR file.

**BK1505 cannot read from file *filename***

BSCMAKE could not read from the given file.

One of the following may have occurred:

- ◆ The file was corrupt.
- ◆ The file was truncated. Truncation can occur if the compiler runs out of disk space or is interrupted when it is creating the .SBR file.

**BK1506 cannot open file *filename***

BSCMAKE could not open the given file.

One of the following may have occurred:

- ◆ No more file handles were available. Increase the number of file handles by changing the FILES setting in CONFIG.SYS to allow a larger number of open files. FILES=50 is the recommended setting.
- ◆ The file was locked by another process.
- ◆ The disk was full.
- ◆ A hardware error occurred.
- ◆ The specified output file had the same name as an existing subdirectory.

**BK1507 cannot open temporary file *filename***

BSCMAKE could not open one of its temporary files.

One of the following may have occurred:

- ◆ No more file handles were available. Increase the number of file handles by changing the FILES setting in CONFIG.SYS to allow a larger number of open files. FILES=50 is the recommended setting.
- ◆ The TMP environment variable was not set to a valid drive and directory.
- ◆ The disk was full.

**BK1508 cannot delete temporary file *filename***

BSCMAKE could not delete one of its temporary files.

One of the following may have occurred:

- ◆ Another process had the file open.
- ◆ A hardware error occurred.

**BK1509 out of heap space**

BSCMAKE ran out of memory.

One of the following may be a solution:

- ◆ Reduce the memory that BSCMAKE will require by using one or more options. Use /Ei or /Es to eliminate some input files. Use /Em to eliminate macro bodies.
- ◆ Run BSCMAKE (or PWB if you are building a database in PWB) in an MS-DOS session within Windows to use virtual memory provided under the Windows operating system.
- ◆ Free some memory by removing terminate-and-stay-resident (TSR) software.
- ◆ Reconfigure the EMM driver.
- ◆ Change CONFIG.SYS to specify fewer buffers (the BUFFERS command) and fewer drives (the LASTDRIVE command).
- ◆ Run BSCMAKEV.EXE instead of BSCMAKE.EXE.

**BK1510 corrupt .SBR file filename**

The given .SBR file is corrupt or does not have the expected format.

Recompile to regenerate the .SBR file.

**BK1511 invalid response file specification**

BSCMAKE did not understand the command-line specification for the response file. The specification was probably wrong or incomplete.

For example, the following specification causes this error:

```
bscmake @
```

**BK1512 database capacity exceeded**

BSCMAKE could not build a database because the number of definitions, references, modules, or other information exceeded the limit for a database.

One of the following may be a solution:

- ◆ Exclude some information using the /Em, /Es, or /Ei option.
- ◆ Omit the /Iu option if it was used.
- ◆ Divide the list of .SBR files and build multiple databases.

**BK1513 nonincremental update requires all .SBR files**

An attempt was made to build a new database, but one or more of the specified .SBR files was truncated. This message is always preceded by warning BK4502, which will give the name of the .SBR file that caused the error.

BSCMAKE can process a truncated, or zero-length, .SBR file only when a database already exists and is being incrementally updated.

One of the following may be a cause:

- ◆ The database file was missing.
- ◆ The wrong database name was specified.
- ◆ The database was corrupted, and a full build was required.

**BK1514 all .SBR files truncated and not in database**

None of the .SBR files specified for an update was a part of the original database. This message is always preceded by warning BK4502, which will give the name of the .SBR file that caused the error.

One of the following may be a cause:

- ◆ The wrong database name was specified.
- ◆ The database was corrupted, and a full build was required.

**BK1515 *bscfile* : incompatible version; cannot incrementally update**

The given database (.BSC file) was not created with this version of BSCMAKE. A database can be incrementally built only by the same version of BSCMAKE as the one used to fully build the database.

## BSCMAKE Warning Messages

**BK4500 UNKNOWN WARNING  
Contact Microsoft Product Support Services**

An unknown error condition was detected by BSCMAKE.

Note the circumstances of the error and notify Microsoft Corporation by following the instructions in the “Microsoft Support Services” section of the introduction to this book.

**BK4501 ignoring unknown option *option***

BSCMAKE did not recognize the given option and ignored it.

If the given option is */r*, it must be specified first on the BSCMAKE command line.

**BK4502 truncated .SBR file *filename* not in database**

The given zero-length .SBR file, specified during a database update, was not originally part of the database.

If a zero-length file that is not part of the original build of the database is specified during a rebuild of that database, BSCMAKE issues this warning. One of the following may be a cause:

- ◆ The wrong database name was specified.
- ◆ The database was deleted (error BK1513 will result).
- ◆ The database file was corrupted, requiring a full build.

**BK4503 minor error in .SBR file *filename* ignored**

The given .SBR file contained an error that did not halt the build. However, the resulting .BSC file may not be correct.

Recompile to regenerate the .SBR file.

## CodeView C/C++ Expression Evaluator Errors

**CAN0000 no error condition**

No error has occurred, and this message should not appear.

You can continue debugging normally.

Note the circumstances of the error and notify Microsoft Corporation by following the instructions in the “Microsoft Support Services” section of the introduction to this book.

**CAN0001 exception executing user function**

The code being executed caused a general protection fault.

**CAN0002 error accessing user memory**

The expression attempts to reference memory that is not allocated to the program being debugged.

**CAN0003 internal error in expression evaluator**

The CodeView expression evaluator encountered an internal error.

Note the circumstances of the error and notify Microsoft Corporation by following the instructions in the “Microsoft Support Services” section of the introduction to this book.

**CAN0004 syntax error**

The syntax of the expression is incorrect.

Retype the expression with the correct syntax.

- CAN0005 operator not supported**  
An unsupported C operator was specified in an expression.  
You can usually write an equivalent expression using the supported C operators.
- CAN0006 missing left parenthesis**  
Unbalanced parentheses were found in the expression.  
Retype the expression with balanced parentheses.
- CAN0007 missing right parenthesis**  
Unbalanced parentheses were found in the expression.  
Retype the expression with balanced parentheses.
- CAN0008 missing \at end of string**  
The double quotation mark (") expected at the end of the string literal was missing.  
Retype the expression, enclosing the string literal in double quotation marks.
- CAN0009 missing ' after character constant**  
The single quotation mark (') expected at the end of the character constant was missing.  
Retype the expression, enclosing the character constant in single quotation marks.
- CAN0010 missing left bracket**  
The expression contains unbalanced square brackets.  
Retype the expression with balanced square brackets.
- CAN0011 missing right bracket**  
The expression contains unbalanced square brackets.  
Retype the expression with balanced square brackets.
- CAN0012 missing left curly brace**  
The expression contains an unbalanced curly brace.  
Retype the expression with balanced curly braces.
- CAN0013 missing operator**  
An operator was expected in the expression but was not found.  
Check the syntax of the expression.
- CAN0014 missing operand**  
An operator was specified without a required operand.  
Check the syntax of the expression.

**CAN0015 expression too complex (stack overflow)**

The expression entered was too complex or nested too deeply for the amount of storage available to the C expression evaluator.

Overflow usually occurs because of too many pending calculations.

Rearrange the expression so that each component of the expression can be evaluated as it is encountered, rather than having to wait for other parts of the expression to be calculated.

Break the expression into multiple commands.

**CAN0016 constant too big**

The CodeView C expression evaluator cannot accept an unsigned integer constant larger than 4,294,967,295 (FFFFFFFF hexadecimal), or a floating-point constant whose magnitude is larger than approximately 1.8E+308.

**CAN0017 symbol not found**

A symbol specified in an expression could not be found.

One possible cause of this error is a case mismatch in the symbol name. Since C and C++ are case-sensitive languages, a symbol name must be given in the exact case in which it is defined in the source.

**CAN0018 bad register name**

A specified register does not exist or cannot be displayed.

CodeView can display the following registers: AX, SP, DS, IP, BX, BP, ES, FL, CX, SI, SS, DX, DI, CS.

When running with MS-DOS on an 80386 machine, the 386 option can be selected to display the following registers: EAX, ESP, DS, GS, EBX, EBP, ES, SS, ECX, ESI, FS, EIP, EDX, EDI, CS, EFL.

**CAN0019 bad type cast**

The CodeView C expression evaluator cannot perform the type cast as written.

One of the following may have occurred:

- ◆ The specified type is unknown.
- ◆ There were too many levels of pointer types.

For example, the type cast:

```
(char far * far *)h_message
```

cannot be evaluated by the CodeView C expression evaluator.

**CAN0020 operand types bad for this operation**

An operator was applied to an expression with an invalid type for that operator.

For example, it is not valid to take the address of a register, or subscript an array with a floating-point expression.



**CAN0021 struct or union used as scalar**

A structure or union was used in an expression, but no element was specified.

When manipulating a structure or union variable, the name of the variable may appear by itself, without a field qualifier. If a structure or union is used in an expression, it must be qualified with the specific element desired.

Specify the element whose value is to be used in the expression.

**CAN0022 function call before `_main`**

The CodeView C expression evaluator cannot evaluate a function before CodeView has entered the function `_main`. The program is not properly initialized until `_main` has been called.

Execute `g main;p` to enable function calls in expressions.

**CAN0023 bad radix**

The radix specified is not recognized by the CodeView C expression evaluator. Only decimal, hexadecimal, and octal radices are valid.

**CAN0024 operation needs l-value**

An expression that does not evaluate to an l-value was specified for an operation that requires an l-value.

An l-value (so called because it appears on the left side of an assignment statement) is an expression that refers to a memory location.

For example, `buffer[count]` is a valid l-value because it points to a specific memory location. The logical comparison `zed != 0` is not a valid l-value because it evaluates to TRUE or FALSE, not a memory address.

**CAN0025 operator needs struct/union**

An operator that takes an expression of struct or union type was applied to an expression that is not a struct or union.

Components of class, structure, or union variables must have a fully qualified name. Components cannot be entered without full specification.

**CAN0026 bad format string**

A format string was improperly specified.

Check the syntax of the expression.

**CAN0027 tp addr not l-value**

Check the syntax of the expression.

**CAN0028 not struct/union element**

An expression of the form `Struct.Member` or `pStruct->Member` was specified, but *member* is not an element of the structure.

The expression may not be parenthesized correctly.

**CAN0029 not struct pointer**

The member-selection operator (`->`) was applied to an expression that is not a pointer to a structure.

Check that the entire expression is parenthesized correctly, or type cast the address expression to the appropriate structure pointer type.

**CAN0030 expression not evaluable**

The expression could not be evaluated as written.

This error is frequently caused by dereferencing a pointer which is not valid.

Check that the syntax of the expression is correct, and that all symbols are specified in the exact case as they are defined in the program.

**CAN0031 expression not expandable**

The CodeView C expression evaluator encountered an internal error.

You may be able to write an equivalent expression that can be evaluated correctly.

Note the circumstances of the error and notify Microsoft Corporation by following the instructions in the "Microsoft Support Services" section of the introduction to this book.

**CAN0032 divide by 0**

The expression contains a divisor of zero, which is illegal. This divisor may be the literal number zero, or it may be an expression that evaluates to zero.

**CAN0033 error in OMF type information**

The executable file did not have a valid OMF (Object Module Format) for debugging by CodeView.

One of the following may have occurred:

- ◆ The executable file was not created with the linker released with this version of CodeView. Relink the object code using the current version of LINK.EXE.
- ◆ The executable file was not created with the high-level language released with this version of CodeView. Recompile the program with the current version of the compiler.
- ◆ The .EXE file may have been corrupted. Recompile and relink the program.

**CAN0034 types incompatible with operator**

The operand types specified are not legal for the operation.

For example, a pointer cannot be multiplied by any value.

You may need to type cast the operands to a type compatible with the operator.

**CAN0035 overlay not resident**

An attempt was made to access an overlay that is not currently resident in RAM.

Execute the program until the overlay is loaded.

**CAN0036 bad context {...} specification**

This message can be generated by any of several errors in the use of the context-resolution operator (`{}`).

◆ The syntax of the context-resolution operator (`{}`) was given incorrectly.

The syntax of the context operator is:

```
{ [function], [module], [dll] } expression
```

This specifies the context of *expression*. The context operator has the same precedence and usage as a type-cast.

Trailing commas can be omitted. If any of `[function]`, `[module]`, or `[dll]` contain a literal comma, you must enclose the entire name in parentheses.

◆ The function name was spelled incorrectly, or does not exist in the specified module or dynamic-link library.

Since C is a case-sensitive language, *function* must be given in the exact case as it is defined in the source. The C expression evaluator ignores the CodeView case-sensitivity state set with the OC command or the Case Sensitive command in the Options menu.

◆ The module or DLL could not be found.

Check the full path name of the specified module or DLL.

**CAN0037 out of memory**

The CodeView C expression evaluator ran out of memory evaluating the expression.

**CAN0038 function argument count and/or type mismatch**

The function call as specified does not match the prototype for the function.

Retype the call with the correct number of arguments. Type cast each argument to match the prototype, as necessary.

**CAN0039 symbol is ambiguous**

The CodeView C expression evaluator cannot determine which instance of a symbol to use in an expression. The symbol occurs more than once in the inheritance tree.

You must use the scope resolution operator (::) to explicitly specify the instance to use in the expression.

**CAN0040 function requires implicit conversion**

Implicit conversions involving constructor calls are not supported by the CodeView C expression evaluator.

**CAN0041 class element must be static member or member function**

A nonstatic member of a class (or structure or union) was used without specifying which instantiation of the class to use.

Only static data members or member functions can be used without specifying an instantiation.

**CAN0042 bad line number**

This error should never occur.

Note the circumstances of the error and notify Microsoft Corporation by following the instructions in the "Microsoft Support Services" section of the introduction to this book.

**CAN0043 this pointer used outside member function**

This pointer can only be used for nonstatic member functions.

**CAN0044 use of `_based(void)` pointer requires `>` operator**

A pointer based on `void` cannot be used directly. You must form a complete pointer using the `>` operator.

**CAN0045 not a function**

An argument list was supplied for a symbol in the program that is not the name of a function.

For example, this error is generated for the expression

```
queue( alpha, beta
```

when `queue` is not a function.

**CAN0046 argument list required for member function**

An expression called a member function but did not specify any actual parameters.

**CAN0047 argument list does not match a function**

An expression called a function with an actual parameter list that did not match the formal parameter list of any function with the same name defined in the program.

Overloaded functions can be called only if there is an exact parameter match, or a match that does not require the construction of an object.

- CAN0048 calling sequence not supported**  
A function specified in the expression uses a calling sequence not supported by the CodeView C expression evaluator. You cannot call this function in a CodeView expression.
- CAN0049 obsolete OMF - please relink program**  
The program used an old OMF (Object Module Format).  
The program must be linked with LINK version 5.30 or later, and packed with CVPACK version 4.0 or later.
- CAN0050 left side of :: must be class/struct/union**  
The symbol on the left side of the scope-resolution operator (::) was not a class, structure or union.
- CAN0051 more than one overloaded symbol specified in breakpoint**  
CodeView could not determine which of more than one overloaded symbol to use as a breakpoint.
- CAN0052 member function not present**  
A member function was specified as a breakpoint but could not be found. This error can be caused by setting a breakpoint at a function that has been inlined.  
Recompile the file with inlining forced off (/Ob0) to set a breakpoint in this function.  
An expression called a function that was not defined.
- CAN0053 nonfunction symbol match while binding breakpoints**  
A symbol used as a breakpoint was not a function. This error can be caused by specifying a data member as a breakpoint.
- CAN0054 register in breakpoint expression illegal**  
A register cannot be used in a breakpoint expression.
- CAN0055 ambiguous symbol in context operator**  
A symbol in the context operator ({} ) referred to more than one symbol in the program.  
The scope resolution operator (::) may be able to resolve the ambiguity.
- CAN0056 error in line number**  
An invalid line number was specified.
- CAN0057 no code at line number**  
No code was generated for the specified line number. It cannot be used as a breakpoint.
- CAN0058 overloaded operator not found**  
A class type was specified as the left operand in an expression, but an overloaded operator was not defined for the class.

**CAN0059 left operand is class not a function name**

The left operand of a function call was a class name and could not be resolved to a function call. This error can be caused by omitting the name of a member function in an expression.

**CAN0060 register is not available**

An expression specified a register that cannot be used.

This error can be caused by trying to access a register that does not exist on the machine running CodeView, for example, accessing 80386-specific registers on an 8088-based machine.

**CAN0061 function nesting depth exceeded**

The expression contains a function nesting depth greater than the limit.

The expression should be modified to reduce the nesting depth.

**CAN0062 constructor calls not supported**

An expression made a call to a constructor.

Expressions cannot make explicit calls to constructors or make conversions that require a call to a constructor.

**CXX0063 overloaded operator -> not supported**

The expression used an overloaded class member access operator (->).

**CXX0064 can't set breakpoint on bound virtual member function**

A breakpoint was set on a virtual member function through a pointer to an object, such as:

```
pClass->vfunc( int );
```

A breakpoint can be set on a virtual function by entering the class, such as:

```
Class::vfunc( int );
```

## CodeView Error Messages

**CV0000 no error; NOERROR; No Error Condition**

You should not normally receive this error message since CV0000 indicates that no error occurred.

**CV0002 no such file or directory**

The specified file does not exist or a path does not specify an existing directory.

Check the file or directory name in the most recent command.

One of the following may have occurred:

- ◆ The View Source (VS) command or the Open Source command from the File menu was used to view a nonexistent file.
- ◆ An attempt was made to print to a nonexistent file or directory.

**CV0003 program terminated: restart to continue**

CodeView has detected a termination request by the program being debugged.

The program cannot be executed because it has terminated and has not been restarted. Program memory remains allocated and may still be examined at this point.

To run the program again, reload it using the Restart command.

**CV0005 I/O error**

An attempt was made to access an address that is not accessible to the program being debugged.

Check the previous command for numeric constants used as addresses and for pointers used for indirection.

**CV0007 number of arguments exceeds DOS limit of 128**

CodeView is not able to restart the program that is being debugged because the number of arguments to the executable program exceeds the limit of 128.

**CV0008 executable file format error**

The system is not able to load the program to be debugged. The file is not an executable file, or it has an invalid format for this operating system.

Try to run the program outside of CodeView to see if it is a valid executable file.

This error can be caused if there is not enough memory available to run the program.

Try making more memory available to the program.

**CV0012 out of memory**

CodeView was unable to allocate or reallocate the memory that it required because not enough memory was available.

Possible solutions include the following:

- ◆ Recompile without symbolic information in some of the modules. CodeView requires memory to hold information about the program being debugged. Compile some modules with the /Zd option instead of /Zi, or don't use either option.
- ◆ Remove other programs or drivers running in the system that could be consuming significant amounts of memory.
- ◆ Decrease the settings in CONFIG.SYS for FILES and BUFFERS.

**CV0013 access denied**

A specified file's permission setting does not allow the required access.

One of the following may have occurred:

- ◆ An attempt was made to write to a read-only file.
- ◆ A locking or sharing violation occurred.
- ◆ An attempt was made to open a directory instead of a file.

**CV0014 invalid address**

The command expected an address but was given an argument that could not be interpreted as a valid address.

A name or constant may have been specified without the period (.) that indicates a filename or line number.

**CV0018 no such file or directory**

The specified file does not exist or a path does not specify an existing directory.

Check the file or directory name in the most recent command.

One of the following may have occurred:

- ◆ The View Source (VS) command or the Open Source command from the File menu was used to view a nonexistent file.
- ◆ An attempt was made to print to a nonexistent file or directory.

**CV0022 invalid argument**

An invalid value was given as an argument.



**CV0024 too many open files**

CodeView could not open a file it needed because a file handle was not available.

Increase the number of file handles by changing the FILES setting in CONFIG.SYS to allow a larger number of open files. FILES=50 is the recommended setting.

The program being debugged may have so many files open that all available handles are exhausted. Check that the program has not left files open unnecessarily. The first four handles are reserved by the operating system.

Additional files can be made available by closing source windows. If more files are needed, set helpbuffers=0 in the [pwb] section of TOOLS.INI. As a result, online help cannot be used but several file handles will be made available.

**CV0028 no space left on device**

The disk does not have any space available for writing.

One of the following may have occurred:

- ◆ CodeView could not find room for writing a temporary file.
- ◆ An attempt was made to write to a disk that was full.

**CV0101 no CodeView information for *filename***

The executable file or dynamic-link library (DLL) did not contain the symbols needed by CodeView.

Be sure to compile the program or DLL using the /Zi option. If linking in a separate step, be sure to use the /CO option. Use the most current version of LINK.

**CV0102 unpacked CodeView information in *filename*: use CVPACK**

For this version of CodeView, you must process all executable files using CVPACK, which compresses the debugging information in the file.

Pass the file through CVPACK.EXE before starting CodeView.

**CV0103 relink *filename* with the current linker**

This version of CodeView expects the executable file to be in the format produced by the current version of the linker.

Make sure PWB, NMAKE, or the compiler is not running an older version of the linker.

**CV0104 CodeView information for *filename* is newer than this version of CodeView**  
The executable file was compiled or linked with a version of a Microsoft compiler that is newer than the version of CodeView you are using.

Try one of the following:

- ◆ Reinstall CodeView that came with the new compiler.
- ◆ Remove older versions of CodeView that may be present on your hard disk.
- ◆ Recompile the program with an older version of a Microsoft compiler.

**CV1001 invalid breakpoint command**  
CodeView could not interpret the breakpoint command.

The command probably used an invalid symbol or the incorrect command format.

**CV1003 extra input ignored**  
The first part of the command line was interpreted correctly.

The remainder of the line could not be interpreted or was unnecessary.

**CV1004 invalid register**  
The Register (**R**) command named a register that does not exist or cannot be displayed. CodeView can access the following registers: AX, SP, DS, IP, BX, BP, ES, FL, CX, SI, SS, DX, DI, CS.

When running with MS-DOS or the Windows operating system on an 80386 or an 80486 machine, the 80386 registers option can be selected to access the following registers: EAX, ESP, DS, GS, EBX, EBP, ES, SS, ECX, ESI, FS, EIP, EDX, EDI, CS, EFL.

When debugging p-code, CodeView can also access the following registers: TL, TH, PQ.

**CV1006 breakpoint number or '\*' expected**  
A breakpoint was specified without a number or asterisk.  
A Breakpoint Clear (BC), Breakpoint Disable (BD), or Breakpoint Enable (BE) command requires one or more numbers to specify the breakpoints or an asterisk to specify all breakpoints.

For example, the following command causes this error:

```
bc rika
```

- CV1007     unable to open file**  
The specified file cannot be opened.  
One of the following may have occurred:
- ◆ The file may not exist in the specified directory.
  - ◆ The filename was misspelled.
  - ◆ The file's attributes are set so that it cannot be opened.
  - ◆ A locking or sharing violation occurred.
- CV1011     no previous regular expression**  
The Repeat Last Find command was executed, but a regular expression (search string) was not previously specified.
- CV1012     regular expression too long**  
The regular expression was too long or complex.  
Use a simpler or more general regular expression.
- CV1016     match not found**  
A string could not be found that matched the search pattern.
- CV1017     syntax error**  
The command contained a syntax error.  
This error is probably caused by an invalid command or expression.
- CV1018     unknown symbol**  
The symbolic name specified could not be found.  
One of the following may have occurred:
- ◆ The specified name was misspelled.
  - ◆ The wrong case was used when case sensitivity was turned on. Case sensitivity is toggled by the Case Sensitivity command from the Options menu or is set by the Option (O) Command-window command.
  - ◆ The module containing the specified symbol may not have been compiled with the /Zi option to include symbolic information.
  - ◆ A search was made for an undefined label or function.

**CV1021 unknown format specifier; specify one of A,B,I,IU,IX,L,LU,LX,R,RL,RT**

An unknown format specifier was given to a View Memory (VM), Memory Dump (MD), or Memory Enter (ME) command.

The valid format specifiers are:

Specifier	Display Format
A	ASCII
B	byte
I	16-bit signed decimal integer
IU	16-bit unsigned decimal integer
IX	16-bit hexadecimal integer
L	32-bit signed decimal integer
LU	32-bit unsigned decimal integer
LX	32-bit hexadecimal integer
R	32-bit single precision floating point
RL	64-bit double precision floating point
RT	80-bit 10-byte real (long double)

This error is probably due to a mistyped command.

**CV1022 invalid flag**

An attempt was made to examine or change a flag, but the flag name was not valid.

Any flags preceding the invalid name were changed to the values specified. Any flags after the invalid name were not changed.

Use the flag mnemonics displayed after entering the R FL command.

**CV1023 no code at this line number**

A line number was specified but code was not generated for that line. This error can be caused by a blank line, comment line, line with program declarations, or line moved or removed by compiler optimization.

To set a breakpoint at a line deleted by the optimizer, recompile the program with the /Od option to turn off optimization.

Note that in a multiline statement the code is associated only with one line of the statement.

This error can be caused by debugging a program whose source has been modified after it was compiled. Recompile the file before running it through CodeView.

**CV1027 invalid radix: specify 8, 10, or 16**

The Radix (N) command takes three radices: 8 (octal), 10 (decimal), and 16 (hexadecimal). Other radices are not permitted. The new radix is always entered as a decimal number, regardless of the current radix.

- CV1031 no source lines at this address**  
An attempt was made to view an address that does not have source code.  
This error can be caused by debugging a program whose source has been modified after it was compiled. Recompile the file before debugging it with CodeView.
- CV1039 not a text file**  
An attempt was made to load a file that is not a text file. The file may be binary data.  
This error can also occur if the first line of a file includes characters that are in the range of ASCII 0 to 8, 14 to 31, or 127 (0x0 to 0x8, 0xE to 0x1F, or 0x7F).  
The Source window can only be used to view text files.
- CV1040 video mode changed without /S option**  
The program being debugged changed screen modes, and CodeView was not set for swapping. The program output is now damaged or unrecoverable.  
To be able to view program output, exit CodeView and restart it with the Swap (/S) option.
- CV1041 file error**  
CodeView could not write to the disk.  
One of the following may have occurred:
- ◆ There was not enough space on the disk.
  - ◆ The file was locked by another process.
- CV1042 library module not loaded**  
The program being debugged uses load-on-demand dynamic-link libraries (DLLs). At least one of these libraries is needed but could not be found.
- CV1043 application output lost; screen exchange is off**  
The program being debugged wrote to the display when the Flip (/F) or Swap (/S) option was turned off. The program output was lost.  
When flipping is on, video page 1 is usually reserved for CodeView. Programs usually write to video page 0 by default. Programs that write to video page 1 must be debugged with swapping on.  
Turn Flip or Swap on to be able to view program output.
- CV1046 invalid executable file: relink**  
The executable file did not have a valid format.  
One of the following may have occurred:
- ◆ The executable file was not created with the linker released with this version of CodeView. Relink the object code using the current version of LINK.EXE.
  - ◆ The .EXE file may have been corrupted. Recompile and relink the program.

**CV1047 overlay not resident**

An attempt was made to access machine code from an overlay section of code that is not currently resident in memory.

Execute the program until the overlay is loaded.

**CV1048 floating-point support not loaded**

An attempt was made to access the math processor registers in a program that does not use floating-point arithmetic.

One of the following can cause this error:

- ◆ Math processor registers can only be accessed through the floating-point library code. If the program does not perform floating-point calculations, this error can occur because the floating-point library code will not be loaded and cannot be used to access math processor registers.
- ◆ If the program does not use floating-point instructions, this error can occur when you attempt to access the math processor before any floating-point instructions have been performed. The run-time library includes a floating-point instruction near the beginning so that the math processor registers are always accessible.
- ◆ If a floating-point instruction occurs in an assembly language routine before such an instruction occurs in the high-level language code that calls the routine, this error occurs.

**CV1050 expression not a memory address**

The expression does not evaluate to an address.

For example, `buffer[count]` is a valid address because it points to a specific memory location. The logical comparison `zed != 0` is not a valid address because it evaluates to TRUE or FALSE, not a memory address.

**CV1051 missing or corrupt emulator information**

Status information about the floating-point emulator is missing or corrupt.

The program probably wrote to this area of memory. Make sure the pointer points to its intended object.

**CV1053 TOOLS.INI not found**

The directory listed in the INIT environment variable did not contain a TOOLS.INI file.

Check the INIT variable to be sure that it points to the correct directory.

**CV1054 cannot read this version of CURRENT.STS**

The state file (CURRENT.STS) has a version number that is not recognized by this version of CodeView.

The old CURRENT.STS was ignored, and a new one will be created when CodeView exits.

- CV1056 cannot understand entry in *filename***  
At least one line in the given file (either the state file or the TOOLS.INI file) could not be interpreted.  
On startup, CodeView reads the state file (CURRENT.STS) and the TOOLS.INI file (if the latter is available).  
Examine the given file to find the problem.
- CV1057 CURRENT.STS not found; creating**  
Since the state file (CURRENT.STS) could not be located at startup, CodeView created a state file.
- CV1058 no source window open**  
A command was entered to manipulate the contents of a Source window, but a Source window was not open.
- CV1059 no CodeView source information**  
CodeView symbol listing for the source file or module being debugged does not exist.  
Be sure the file was compiled with the /Zi option or the /Zd option. If linking in a separate step, be sure to use the /CO option.
- CV1060 command not supported for current configuration**  
If you have specified the two monitors option (/2), you cannot specify the flip/swap option (/of- or /of+) from the CodeView Command Window.
- CV1061 no second monitor connected to system**  
CodeView was invoked with the /2 option, but there was only one monitor for CodeView to use.
- CV1062 invalid code-segment context change**  
An attempt was made to set the IP register to a line or address in a different segment.
- CV1063 cannot create CURRENT.STS**  
CodeView could not find an existing state file (CURRENT.STS), and CodeView tried to create one but failed.  
One of the following may have occurred:
- ◆ There was not enough space either on the disk containing the program to be debugged or on the disk pointed to by the INIT environment variable.
  - ◆ There were not enough free file handles. Increase the number of file handles by changing the FILES setting in CONFIG.SYS to allow a larger number of open files.
  - ◆ The environment variable INIT pointed to a directory that does not exist.

**CV1064 window could not be opened**

CodeView tried to open a window, but failed to do so.

This error is probably caused by a lack of memory available to CodeView.

Exit CodeView and make more memory available, then restart CodeView.

**CV1065 cannot load expression evaluator *filename***

CodeView could not load the specified expression evaluator.

Make sure that *filename* is a valid expression evaluator DLL. If not, try reinstalling the CodeView DLLs from the distribution disks.

**CV1066 cannot load expression evaluator *filename*; limit is 10**

Up to 10 expression evaluators can be specified in the TOOLS.INI file.

Try removing expression evaluators you won't be using in your debugging session.

**CV1067 extension missing for Expression Evaluator: *filename* in TOOLS.INI**

The Eval entry in the TOOLS.INI file expected a list of filename extensions.

**CV1068 breakpoint specifier is out of range**

The breakpoint number specified was higher than the number of current breakpoints.

**CV1250 general expression-evaluator error**

An error occurred in a CodeView expression evaluator.

This error is probably caused by a lack of memory available to the expression evaluator.

You can free memory by doing one or more of the following:

- ◆ Close windows that are not needed. The Memory window should be closed if possible.
- ◆ Delete breakpoints that are not needed.
- ◆ Disable options that are not needed.

As a last resort, exit CodeView and start the debugging session again.

This error can also be caused by an expression that cannot be evaluated by the expression evaluator.

**CV1251 *message***

An error occurred within a CodeView expression evaluator.

No further explanation is available.



- CV1254 invalid address expression**  
The expression entered does not evaluate to an address.  
The expression must be in a form that can appear on the left side of an assignment and refer to a memory location.  
For example, `buffer[count]` is a valid l-value because it points to a specific memory location. The logical comparison `zed != 0` is not a valid l-value because it evaluates to TRUE or FALSE, not a memory address.
- CV1255 no data members**  
The class, structure, or union that was expanded did not have data members. A class must contain at least one data member to be expanded.
- CV2206 corrupt CodeView information in *filename*; discarding**  
This error can be caused by using mismatched versions of development tools. Verify that the versions of all tools are current and synchronized.  
Try recompiling the file with the `/Zd` switch (Prepare for Debugging option).  
This option produces an object file containing only public symbols (global or external) and line numbers.
- CV2207 loaded symbols for *module***  
CodeView automatically loaded the symbols for the given dynamic-link library (DLL). The DLL can now be debugged.  
This message is for your information only and does not indicate an error.
- CV2209 cannot restart; current process is not the process being debugged**  
The debugging session was halted, and a different process was started.  
Return to the debugged program's process by setting a breakpoint in it and issue a Go command.
- CV2210 invalid tab setting; using 8**  
The value for tabs cannot be less than 0 or greater than 19. If you supply a value that is not in this range, the default tab value is 8.
- CV2211 cannot terminate; current process is not the process being debugged**  
The debugging session was halted, and a different process was current.  
Return to the debugged program's process by setting a breakpoint in it and issue a Go command.
- CV2401 missing argument for *option option***  
This error can be caused by splitting a response file line naming a program to be debugged and its command-line options. The program name and its command-line option must be on one line.

- CV2402 unknown option *option*; ignored**  
The specified option was not a valid option.  
Check that the option was typed correctly.
- CV2403 response files cannot be nested**  
A response file cannot refer to another response file.
- CV2404 cannot open response file: *filename***  
The specified response file could not be opened.  
Check that the name of the file is spelled correctly and that the response file is correct.
- CV2405 command line option, *option*, invalid for target operating system**  
The specified command line option was illegal in this context.
- CV2406 command-line is too big. arguments truncated**  
The command line argument in a response file was longer than the limit of 256 bytes.
- CV3608 out of memory**  
CodeView needed additional memory, but insufficient memory was available.  
Possible solutions include the following:
- ◆ Remove some drivers or applications that have been loaded in high memory.
  - ◆ Recompile without symbolic information in some of the modules. CodeView requires memory to hold information about the program being debugged. Compile some modules with the /Zd option instead of /Zi, or don't use either option.
  - ◆ Remove other programs or drivers running in the system that could be consuming significant amounts of high memory.
  - ◆ Free some memory by removing terminate-and-stay-resident (TSR) software.
  - ◆ Remove unneeded watch expressions or breakpoints.
- CV3620 bad DLL format in *filename***  
CodeView did not recognize the format of the specified CodeView dynamic-link library (DLL) file.  
The DLL may be damaged or may be the wrong version.  
This error is caused if the specified file is not a DLL.
- CV3621 cannot find DLL *filename***  
CodeView could not find the specified dynamic-link library (DLL). This may be caused by a mistyped filename in the TOOLS.INI file.

- CV3622 cannot load DLL *filename***  
CodeView was unable to load the specified dynamic-link library (DLL) file.  
Reinstall the CodeView DLL from the distribution disks.
- CV3623 wrong DLL *filename***  
CodeView expected one type of dynamic-link library (DLL) but read a different type. This error is probably caused by specifying an incorrect filename in the TOOLS.INI file. For example, you may have specified an execution model in the expression-evaluator entry.
- CV3624 cannot load execution model *filename* - limit is 1**  
Too many execution models are specified in the TOOLS.INI file.  
Only one execution model can be used at a time.  
Remove those execution models you are not using in your debugging session.
- CV3625 no transport layer; exiting**  
CodeView needs a transport layer to make appropriate calls to the operating system in local debugging and to a remote computer in remote debugging.  
Check your TOOLS.INI file, and make sure there is a Transport entry in the [cv] or [cvw] CodeView section.
- CV3626 no execution model; exiting**  
CodeView needs an execution model in order to function.  
Check your TOOLS.INI file, and make sure there is a Native entry specified.
- CV3627 no nonnative execution models found**  
You must specify a nonnative execution model in order to debug a p-code program.  
Add the following line to your TOOLS.INI file:  
`model:nmd1pcd.dll`
- CV3628 too many transport layers: choose one**  
Only one transport layer can be selected at one time.
- CV3629 too many execution models: choose one**  
Only one execution model can be selected at a time.  
Additional execution models should be removed.
- CV3630 no symbol handler found; exiting**  
A symbol handler dynamic-link library (DLL) could not be found. The DLLs that CodeView uses must be in a location specified by the cvdllpath entry in the [cvw] or [cv] section of TOOLS.INI.

- CV3631 program being debugged contains p-code, but no *model*: specified in tools.ini**  
The entry `model=nmd1pcd.dll` must be specified in TOOLS.INI to debug a program that contains p-code.
- CV4000 assembler: not enough operands**  
Additional operands are required for this instruction.  
The instruction was rejected and the address was not advanced.
- CV4001 assembler: too many operands**  
Too many operands were specified for the most recently issued instruction.  
The instruction was rejected and the address was not advanced.
- CV4002 assembler: incorrect operand size**  
An instruction required an operand of a different size.  
The instruction was rejected and the address was not advanced.
- CV4003 assembler: illegal range**  
The size of a specified value exceeds the size expected by the instruction.  
The instruction was rejected and the address was not advanced.
- CV4004 assembler: overflow**  
Numeric overflow occurred while assembling the current instruction.  
The instruction was rejected and the address was not advanced.
- CV4005 assembler: syntax error**  
The syntax for the instruction is incorrect.  
The instruction was rejected and the address was not advanced.
- CV4006 assembler: unknown opcode**  
An instruction was not recognized.  
Check that the instruction was typed correctly.  
The instruction was rejected and the address was not advanced.
- CV4007 assembler: extra characters**  
The instruction contained extra characters that could not be recognized. The instruction may have been mistyped.  
The line was ignored.  
The instruction was rejected and the address was not advanced.

- CV4008 assembler: illegal operand**  
The wrong type of operand was used for this context.  
The instruction may have been mistyped.  
The instruction was rejected and the address was not advanced.
- CV4009 assembler: illegal segment**  
An invalid segment was used.  
The instruction was rejected and the address was not advanced.
- CV4010 assembler: illegal register**  
An illegal or nonexistent register was accessed.  
The register name may have been mistyped.  
This error can be caused by trying to access 80386- or 80486-specific registers when CodeView is running on an 8088- or 80286-based machine.  
The instruction was rejected and the address was not advanced.
- CV4011 assembler: divide by zero**  
CodeView encountered a divide-by-zero error while assembling the current instruction.  
The instruction was rejected and the address was not advanced.
- CV4012 cannot assemble code with current execution model**  
This error can be caused by trying to assemble p-code in CodeView.
- CV4500 bad fixed format length: using variable length**  
An invalid length was specified for the Memory window. CodeView will set the length based on the current window width.  
Try specifying a different length.
- CV4501 invalid window id**  
The window ID was invalid. It must be either 0 or 1.
- CV4502 unable to open the requested memory window**  
CodeView could not open a Memory window.  
The only valid window IDs are 0 and 1. You may need to close some windows.
- CV5001 cannot select**  
The cursor was not on the same line as an automatically selectable symbol.
- CV5004 cannot read file**  
CodeView could not read a file.  
Read the file again. If the second read fails, exit and restart CodeView. If the read process still fails, the file may be corrupt.

**CV5005 no file selected**

A module must be selected before OK is chosen.

To exit the dialog box without selecting a module, choose Cancel.

**CV5009 no watch expression to delete**

An attempt was made to delete one or more watch variables (watch expressions), but watch expressions are not currently selected.

**CV5012 packed executable file**

CodeView cannot step through the beginning of files that are linked with the /EXEPACK option. There are two solutions to this problem:

- ◆ Relink without this option to debug the file and then switch back to linking with /EXEPACK for the release version of your program.
- ◆ Execute the program through startup code, and set breakpoints only after the program has entered main.

**CV5013 no expression evaluators found; exiting**

CodeView needs at least one expression evaluator in order to operate.

Check the [cv] or [cvw] section of your TOOLS.INI file and specify at least one Eval entry.

**CV5014 cannot execute function in watch expression**

A watch expression cannot specify a function to be executed.

## CVPACK Error Messages

Microsoft Debugging Information Compactor (CVPACK) generates the following error messages:

- ◆ Fatal errors (CK1xxx) cause CVPACK to stop execution.
- ◆ Warnings (CK4xxx) indicate possible problems in the packing process.

## CVPACK Fatal Error Messages

**CK1000 unknown error; contact Microsoft Product Support Services**

CVPACK detected an unknown error condition.

Note the circumstances of the error and notify Microsoft Corporation by following the instructions in the “Microsoft Support Services” section of the introduction to this book.

**CK1001 out of memory**

The executable file is too big for the available memory. This error can occur with MS-DOS when there is little extra memory. Even though CVPACK uses virtual memory, which involves swapping to disk, some information can be stored only in real memory.

One of the following may be a solution:

- ◆ Assemble and link in separate steps (that is, use NMAKE).
- ◆ Recompile one or more of the object files without debugging information. If the file was compiled using the /Zi option, use either /Zd or no option.
- ◆ Add more memory to your computer.

**CK1002 out of virtual memory**

There was not enough virtual memory for CVPACK to pack the executable file. Virtual memory can be any of the following:

- ◆ Conventional memory. Remove TSR (terminate-and-stay-resident) programs or run CVPACK outside of a shell or a makefile.
- ◆ Extended or expanded memory. Run CVPACK under a DPMI server, or as an MS-DOS session within the Windows operating system (386 Enhanced Mode).
- ◆ Disk space. Free some disk storage.

**CK1003 cannot open file**

CVPACK could not open the specified executable file.

One of the following may be a cause:

- ◆ The specified file does not exist. Check the spelling of the filename and path.
- ◆ The executable file was opened or deleted by another process.

**CK1004 file is read-only**

CVPACK cannot pack a read-only file. Change the read attribute on the executable file and run CVPACK again.

**CK1005 invalid executable file**

CVPACK could not process the executable file. One of the following may be a cause:

- ◆ The debugging information in the executable file is corrupt.
- ◆ The executable file is a zero-length file.

**CK1006 invalid module *module***

The given object file did not have a valid format.

Check the linker version.

- CK1007**    **invalid *table* table in module *module***  
The given table in the given object file was not valid.  
Check the compiler and linker versions.
- CK1008**    **cannot write packed information**  
There was not enough space on disk for CVPACK to write the packed executable file. This leaves a corrupt file on disk.  
Make more space available on disk and relink the program.
- CK1009**    **module *module* unknown type index *number*;**  
**contact Microsoft Product Support Services**  
The debugging information in the executable file is corrupt. This is due to an internal error in either the compiler or CVPACK. Recompile the program. If the problem persists, note the circumstances of the error and notify Microsoft Corporation by following the instructions in the "Microsoft Support Services" section of the introduction to this book.
- CK1010**    **symbol error in module *module*;**  
**contact Microsoft Product Support Services**  
The debugging information in the executable file is corrupt. This is due to an internal error in either the compiler or CVPACK. Recompile the program. If the problem persists, note the circumstances of the error and notify Microsoft Corporation by following the instructions in the "Microsoft Support Services" section of the introduction to this book.
- CK1011**    **error in type *number* for module *module*;**  
**contact Microsoft Product Support Services**  
The debugging information in the executable file is corrupt. This is due to an internal error in either the compiler or CVPACK. Recompile the program. If the problem persists, note the circumstances of the error and notify Microsoft Corporation by following the instructions in the "Microsoft Support Services" section of the introduction to this book.
- CK1012**    **no Symbol and Type Information**  
The executable file does not contain debugging information.  
Link the program using the /CO option to put at least minimal debugging information in the executable file. To include full debugging information in an object file, compile or assemble using the /Zi option. To include minimal information and line numbers, compile or assemble using the /Zd option.



**CK1013 debugging information missing or unknown format**

One of the following has occurred:

- ◆ The program did not contain debugging information. Recompile using /Zi or /Zd, then link using /CO.
- ◆ The executable file was linked using an obsolete or unsupported linker. Use Microsoft LINK version 5.3x or later.
- ◆ The executable file was already packed using a previous version of CVPACK.

**CK1014 module *module* type *number* refers to skipped type index; contact Microsoft Product Support Services**

The debugging information in the executable file is corrupt. This is due to an internal error in the compiler. Recompile the program. If the problem persists, note the circumstances of the error and notify Microsoft Corporation by following the instructions in the “Microsoft Support Services” section of the introduction to this book.

**CK1015 too many segments in module *module***

The **alloc\_text** pragma was used more than 20 times in an object file that was compiled with Microsoft C version 6.x or earlier.

One of the following may be a solution:

- ◆ Recompile using Microsoft C/C++ version 7.0 or later.
- ◆ Split the object file into multiple files.
- ◆ Group the pragma statements according to segment.

**CK1016 unable to execute MPC for CVPACK /PCODE**

CVPACK could not find MPC.EXE on the path.

**CK1017 precompiled types file *filename* not found**

The program used a precompiled header, but the program was linked without the object file that was created when the header was precompiled.

**CK1018 precompiled types object file *filename* inconsistent with precompiled header used to compile object file *filename***

The program used a precompiled header, but the object file linked to the program was not the object file that was created when the header was precompiled. Either the user or the creator changed since the last compilation.

Recompile and relink. If a makefile is used, check the makefile dependencies.

- CK1020**    **packed type index exceeds 65535 in module *module***  
The debugging information exceeded a CVPACK limit.  
This error may occur when precompiled headers are used.  
One of the following may be a solution:
- ◆ Eliminate unused type strings.
  - ◆ Compile some object files without debugging information.
- CK1021**    **error in precompiled types signature in module *module***  
The program was compiled with an out-of-date precompiled header.  
Delete the object file and recompile.
- CK 1022**    **Symbol table for *file* is too large**  
The corrective action is to compile *file* without CodeView information, reduce the number of symbols in the file, or split the file into two or more pieces.

## CVPACK Warning Messages

- CK4000**    **unknown warning; contact Microsoft Product Support Services**  
CVPACK detected an unknown error condition.  
  
Note the circumstances of the error and notify Microsoft Corporation by following the instructions in the “Microsoft Support Services” section of the introduction to this book.
- CK4001**    **file already packed**  
CVPACK took no action because the executable file has already been processed by CVPACK 4.00.
- CK4002**    **duplicate public symbol *symbol* in module *module***  
The given symbol was redefined in the given module. CVPACK deleted the second occurrence of the symbol.  
  
Probably an earlier version of the linker was used. Use LINK 5.30 or later.
- CK4003**    **error in lexical scopes for module *module*, symbols deleted**  
The scoping of symbols in the given object module was corrupted. CVPACK deleted the symbols in the module.  
  
This is probably a compiler error. Recompile and relink the object file.

## EXEHDR Error Messages

This section includes error messages generated by the Microsoft EXE File Header Utility (EXEHDR). EXEHDR errors (U1100 through U1140) are always fatal.

## EXEHDR Fatal Error Messages

- U1110**     **malformed number** *number*  
A command-line option for EXEHDR required a value, but the given number was mistyped.
- U1111**     **option requires value**  
A command-line option for EXEHDR required a value, but no value was specified or the specified value was in an illegal format for the given option.
- U1112**     **value out of legal range** *lower – upper*  
A command-line option for EXEHDR required a value, but the specified number did not fall in the required decimal range.
- U1113**     **value out of legal range** *lower – upper*  
A command-line option for EXEHDR required a value, but the specified number did not fall in the required hexadecimal range.
- U1114**     **missing option value; option** *option* **ignored**  
The given command-line option for EXEHDR required a value, but nothing was specified. EXEHDR ignored the option.
- U1115**     **option** *option* **ignored**  
The given command-line option for EXEHDR was ignored. This error usually occurs with error U1116, unrecognized option.
- U1116**     **unrecognized option:** *option*  
A command-line option for EXEHDR was not recognized. This error usually occurs with either U1115, option ignored, or U1111, option requires value.
- U1120**     **input file missing**  
No input file was specified on the EXEHDR command line.
- U1121**     **command line too long:** *commandline*  
The given EXEHDR command line exceeded the limit of 512 characters.
- U1130**     **cannot read** *filename*  
EXEHDR could not read the input file. Either the file is missing or the file attribute is set to prevent reading.
- U1131**     **invalid .EXE file**  
The input file specified on the EXEHDR command line was not recognized as an executable file.
- U1132**     **unexpected end-of-file**  
EXEHDR found an unexpected end-of-file condition while reading the executable file. The file is probably corrupt.

**U1140 out of memory**

There was not enough memory for EXEHDR to decode the header of the executable file.

## Math Coprocessor Error Messages

The error messages listed below correspond to exceptions generated by the math coprocessor hardware. Refer to the manufacturer's documentation for your processor for a detailed discussion of hardware exceptions. These errors may also be detected by the floating-point emulator or alternate math library.

**M6101 invalid**

An invalid operation occurred. This error usually occurs when the operand is NAN (not a number) or infinity.

This error terminates the program with exit code 129.

**M6102 denormal**

A very small floating-point number was generated, which may no longer be valid because of a loss of significance. Denormal floating-point exceptions are usually masked, causing them to be trapped and operated upon.

This error terminates the program with exit code 130.

**M6103 divide by 0**

A floating-point operation attempted to divide by zero.

This error terminates the program with exit code 131.

**M6104 overflow**

An overflow occurred in a floating-point operation.

This error terminates the program with exit code 132.

**M6105 underflow**

An underflow occurred in a floating-point operation. Underflow floating-point exceptions are usually masked, causing the underflowing value to be replaced by 0.0.

This error terminates the program with exit code 133.

**M6106 inexact**

Loss of precision occurred in a floating-point operation. This exception is usually masked. Many floating-point operations cause a loss of precision.

This error terminates the program with exit code 134.

- M6107 unemulated**  
An attempt was made to execute a coprocessor instruction that is invalid or is not supported by the emulator.  
This error terminates the program with exit code 135.
- M6108 square root**  
The operand in a square-root operation was negative.  
This error terminates the program with exit code 136.  
The **sqrt** function in the C run-time library and the FORTRAN intrinsic function **SQRT** do not generate this error. The C **sqrt** function checks the argument before performing the operation and returns an error value if the operand is negative. The FORTRAN **SQRT** function generates the DOMAIN error M6201 instead of this error.
- M6110 stack overflow**  
A floating-point expression caused a stack overflow on the 8087/80287/80387 coprocessor or the emulator.  
Stack-overflow floating-point exceptions are trapped up to a limit of seven levels in addition to the eight levels usually supported by the 8087/80287/80387 coprocessor.  
This error terminates the program with exit code 138.
- M6111 stack underflow**  
A floating-point operation resulted in a stack underflow on the 8087/80287/80387 coprocessor or the emulator.  
This error terminates the program with exit code 139.
- M6201 *function* : \_DOMAIN error**  
An argument to the given function was outside the domain of legal input values for that function.
- M6202 *function* : \_SING error**  
An argument to the given function was a singularity value for this function. The function is not defined for that argument.  
For example, in FORTRAN the following statement generates this error:  

```
result = LOG10(0.0)
```

  
This error calls the **\_matherr** function with the function name, its arguments, and the error type. You can rewrite the **\_matherr** function to customize the handling of certain run-time floating-point math errors.

**M6203**     *function* : **\_OVERFLOW error**

The given function result was too large to be represented.

This error calls the **\_matherr** function with the function name, its arguments, and the error type. You can rewrite the **\_matherr** function to customize the handling of certain run-time floating-point math errors.

**M6205**     *function* : **\_TLOSS error**

A total loss of significance (precision) occurred.

This error may be caused by giving a very large number as the operand of **sin**, **cos**, or **tan** because the operand must be reduced to a number between 0 and  $2\pi$ .

## H2INC Error Messages

### H2INC Fatal Errors

**HI1003**     **error count exceeds n; stopping compilation**

Errors in the program were too numerous or too severe to allow recovery, and the compiler must terminate.

**HI1004**     **unexpected end-of-file found**

The default disk drive did not contain sufficient space for the compiler to create temporary files. The space required is approximately two times the size of the source file.

This message also appears when the **#if** directive occurs without a corresponding closing **#endif** directive while the **#if** test directs the compiler to skip the section.

**HI1007**     **unrecognized flag *string* in *option***

The *string* in the command-line *option* was not a valid option.

**HI1008**     **no input file specified**

The compiler was not given a file to compile.

**HI1009**     **compiler limit : macros nested too deeply**

Too many macros were being expanded at the same time.

This error occurs when a macro definition contains macros to be expanded and those macros contain other macros.

Try to split the nested macros into simpler macros.

**HI1011**     **compiler limit : *identifier* : macro definition too big**

The macro definition was longer than allowed.

Split the definition into shorter definitions.

- HI1012**     **unmatched parenthesis nesting - missing *character***  
The parentheses in a preprocessor directive were not matched. The missing character is either a left, (, or right, ), parenthesis.
- HI1016**     **`#if[n]def` expected an identifier**  
An identifier must be specified with the **`#ifdef`** and **`#ifndef`** directives.
- HI1017**     **invalid integer constant expression**  
The expression in an **`#if`** directive either did not exist or did not evaluate to a constant.
- HI1018**     **unexpected `'#elif'`**  
The **`#elif`** directive is legal only when it appears within an **`#if`**, **`#ifdef`**, or **`#ifndef`** construct.
- HI1019**     **unexpected `'#else'`**  
The **`#else`** directive is legal only when it appears within an **`#if`**, **`#ifdef`**, or **`#ifndef`** construct.
- HI1020**     **unexpected `'#endif'`**  
An **`#endif`** directive appeared without a matching **`#if`**, **`#ifdef`**, or **`#ifndef`** directive.
- HI1021**     **invalid preprocessor command *string***  
The characters following the number sign (#) did not form a valid preprocessor directive.
- HI1022**     **expected `'#endif'`**  
An **`#if`**, **`#ifdef`**, or **`#ifndef`** directive was not terminated with an **`#endif`** directive.
- HI1023**     **cannot open source file *filename***  
The given file either did not exist, could not be opened, or was not found.  
Make sure the environment settings are valid and that the correct path name for the file is specified.  
If this error appears without an error message, the compiler has run out of file handles. If in MS-DOS, increase the number of file handles by changing the FILES setting in CONFIG.SYS to allow a larger number of open files. FILES=20 is the recommended setting.
- HI1024**     **cannot open include file *filename***  
The specified file in an **`#include`** preprocessor directive could not be found.  
Make sure settings for the INCLUDE and TMP environment variables are valid and that the correct path name for the file is specified.  
If this error appears without an error message, the compiler has run out of file handles. If in MS-DOS, increase the number of file handles by changing the FILES setting in CONFIG.SYS to allow a larger number of open files. FILES=20 is the recommended setting.

**HI1026**     **parser stack overflow, please simplify your program**

The program cannot be processed because the space required to parse the program causes a stack overflow in the compiler.

Simplify the program by decreasing the complexity of expressions. Decrease the level of nesting in for and switch statements by putting some of the more deeply nested statements in separate functions. Break up very long expressions involving ',' operators or function calls.

**HI1033**     **cannot open assembly language output file *filename***

There are several possible causes for this error:

- ◆ The given name is not valid
- ◆ The file cannot be opened for lack of space.
- ◆ A read-only file with the given name already exists.

**HI1036**     **cannot open source listing file *filename***

There are several possible causes for this error:

- ◆ The given name is not valid.
- ◆ The file cannot be opened for lack of space.
- ◆ A read-only file with the given name already exists.

**HI1039**     **unrecoverable heap overflow in Pass 3**

The post-optimizer compiler pass overflowed the heap and could not continue.

One of the following may be a solution:

- ◆ Break up the function containing the line that caused the error.
- ◆ Recompile with the /Od option, removing optimization.
- ◆ In MS-DOS, remove other programs or drivers running in the system which could be consuming significant amounts of memory.
- ◆ In MS-DOS, if using NMAKE, compile without using NMAKE.

**HI1040**     **unexpected end-of-file in source file *filename***

The compiler detected an unexpected end-of-file condition while creating a source listing or mingled source/object listing.

**HI1047**     **limit of *option* exceeded at *string***

The given option was specified too many times. The given string is the argument to the option that caused the error.

If the CL or H2INC environment variables have been set, options in these variables are read before options specified on the command line. The CL environment variable is read before the H2INC environment variable.



- HI1048** This error existed in previous versions of H2INC as “unknown option *character* in *option*.” This condition now generates warning HI4799.
- HI1049** This error existed in previous versions of H2INC as “invalid numerical argument *string*.” This condition now generates warning HI4052.
- HI1050** ***segment* : code segment too large**  
A code segment grew to within 36 bytes of 64K during compilation.  
A 36-byte pad is used because of a bug in some 80286 chips that can cause programs to exhibit strange behavior when, among other conditions, the size of a code segment is within 36 bytes of 64K.
- HI1052** **compiler limit : #if/#ifdef nested too deeply**  
The program exceeded the maximum of 32 nesting levels for **#if** and **#ifdef** directives.
- HI1053** **compiler limit : struct/union nested too deeply**  
A structure or union definition was nested to more than 15 levels.  
Break the structure or union into two parts by defining one or more of the nested structures using **typedef**.
- HI1090** ***segment* data allocation exceeds 64K**  
The size of the named segment exceeds 64K.  
This error occurs with **\_based** allocation.
- HI1800** This error existed in previous versions of H2INC as “*option*: unrecognized option.” This condition now generates warning HI4799.
- HI1801** **incomplete model specification**  
Only part of a custom memory-model specification was specified on the command line.  
When you specify a custom memory model with the /A command-line option, you must specify code pointer distance, data pointer distance, and DS register setup. This error is equivalent to the D2013 error message for CL.

## H2INC Nonfatal Errors

- HI2000** **UNKNOWN ERROR Contact Microsoft Product Support Services**  
The compiler detected an unknown error condition.  
Note the circumstances of the error and notify Microsoft Corporation by following the instructions in the “Microsoft Support Services” section of the introduction to this book.

**HI2001    newline in constant**

A string constant was continued onto a second line without either a backslash or closing and opening quotes.

To break a string constant onto two lines in the source file, do one of the following:

- ◆ End the first line with the line-continuation character, a backslash, \.
- ◆ Close the string on the first line with a double quotation mark, and open the string on the next line with another quotation mark.

It is not sufficient to end the first line with \n, the escape sequence for embedding a newline character in a string constant.

The following two examples demonstrate causes of this error:

```
printf("Hello,  
world");
```

or

```
printf("Hello, \n  
world");
```

The following two examples show ways to correct this error:

```
printf("Hello, \n  
world");
```

or

```
printf("Hello, "  
" world");
```

Note that any spaces at the beginning of the next line after a line-continuation character are included in the string constant. Note, also, that neither solution actually places a newline character into the string constant. To embed this character:

```
printf("Hello, \n\  
world");
```

or

```
printf("Hello,\nworld");
```

or

```
printf("Hello,\n"world");
```

or

```
printf("Hello, "\nworld");
```

- HI2003** **expected *defined id***  
An identifier was expected after the preprocessing keyword *defined*.
- HI2004** **expected *defined(id)***  
An identifier was expected after the left parenthesis, (, following the preprocessing keyword *defined*.
- HI2005** **#line expected a line number, found *token***  
A **#line** directive lacked the required line-number specification.
- HI2006** **#include expected a file name, found *token***  
An **#include** directive lacked the required file-name specification.
- HI2007** **#define syntax**  
An identifier was expected following **#define** in a preprocessing directive.
- HI2008** ***character* : unexpected in macro definition**  
The given character was found immediately following the name of the macro.
- HI2009** **reuse of macro formal *identifier***  
The given identifier was used more than once in the formal-parameter list of a macro definition.
- HI2010** ***character* : unexpected in macro formal-parameter list**  
The given character was used incorrectly in the formal-parameter list of a macro definition.
- HI2012** **missing name following '<'**  
An **#include** directive lacked the required filename specification.
- HI2013** **missing '>'**  
The closing angle bracket (>) was missing from an **#include** directive.

- HI2014**     **preprocessor command must start as first non-white-space**  
Non-white-space characters appeared before the number sign (#) of a preprocessor directive on the same line.
- HI2015**     **too many characters in constant**  
A character constant contained more than one character.  
Note that an escape sequence (for example, \t for tab) is converted to a single character.
- HI2016**     **no closing single quotation mark**  
A newline character was found before the closing single quotation mark of a character constant.
- HI2017**     **illegal escape sequence**  
An escape sequence appeared where one was not expected.  
An escape sequence (a backslash, \, followed by a number or letter) may occur only in a character or string constant.
- HI2018**     **unknown character** *hexnumber*  
The ASCII character corresponding to the given hexadecimal number appeared in the source file but is an illegal character.  
One possible cause of this error is corruption of the source file. Edit the file and look at the line on which the error occurred.
- HI2019**     **expected preprocessor directive, found** *character*  
The given character followed a number sign (#), but it was not the first letter of a preprocessor directive.
- HI2021**     **expected exponent value, not** *character*  
The given character was used as the exponent of a floating-point constant but was not a valid number.
- HI2022**     ***number* : too big for character**  
The octal number following a backslash (\) in a character or string constant was too large to be represented as a character.
- HI2025**     ***identifier* : enum/struct/union type redefinition**  
The given identifier had already been used for an enumeration, structure, or union tag.
- HI2026**     ***identifier* : member of enum redefinition**  
The given identifier has already been used for an enumeration constant, either within the same enumeration type or within another visible enumeration type.
- HI2027**     **use of undefined enum/struct/union** *identifier*  
The given identifier referred to a structure or union type that was not defined.

- HI2028**     **struct/union member needs to be inside a struct/union**  
Structure and union members must be declared within the structure or union.  
This error may be caused by an enumeration declaration containing a declaration of a structure member, as in the following example:
- ```
enum a {  
    january,  
    february,  
    int march; /* Illegal structure declaration */  
};
```
- HI2030**     *identifier* : **struct/union member redefinition**  
The identifier was used for more than one member of the same structure or union.
- HI2031**     *identifier* : **function cannot be struct/union member**  
The given function was declared to be a member of a structure or union.  
To correct this error, use a pointer to the function instead.
- HI2033**     *identifier* : **bit field cannot have indirection**  
The given bit field was declared as a pointer (\*), which is not allowed.
- HI2034**     *identifier* : **type of bit field too small for number of bits**  
The number of bits specified in the bit-field declaration exceeded the number of bits in the given base type.
- HI2035**     **struct/union identifier : unknown size**  
The given structure or union had an undefined size.  
Usually this occurs when referencing a declared but not defined structure or union tag.  
For example, the following causes this error:
- ```
struct s_tag *ps;  
ps = &my_var;  
*ps = 17; /* This line causes the error */
```
- HI2037**     **left of operator specifies undefined struct/union identifier**  
The expression before the member-selection operator (-> or .) identified a structure or union type that was not defined.
- HI2038**     *identifier* : **not struct/union member**  
The given identifier was used in a context that required a structure or union member.
- HI2041**     **illegal digit character for base number**  
The given character was not a legal digit for the base used.

**HI2042 signed/unsigned keywords mutually exclusive**

The keywords *signed* and *unsigned* were both used in a single declaration, as in the following example:

```
unsigned signed int i;
```

**HI2056 illegal expression**

An expression was illegal because of a previous error, which may not have produced an error message.

**HI2057 expected constant expression**

The context requires a constant expression.

**HI2058 constant expression is not integral**

The context requires an integral constant expression.

**HI2059 syntax error : token**

The token caused a syntax error.

**HI2060 syntax error : end-of-file found**

The compiler expected at least one more token.

Some causes of this error include:

- ◆ Omitting a semicolon (;), as in

```
int *p
```

- ◆ Omitting a closing brace (}) from the last function, as in

```
main()  
{
```

**HI2061 syntax error : identifier *identifier***

The identifier caused a syntax error.

**HI2062 type *type* unexpected**

The compiler did not expect the given type to appear here, possibly because it already had a required type.

**HI2063 *identifier* : not a function**

The given identifier was not declared as a function, but an attempt was made to use it as a function.

**HI2064 term does not evaluate to a function**

An attempt was made to call a function through an expression that did not evaluate to a function pointer.

- HI2065**     *identifier : undefined*  
An attempt was made to use an identifier that was not defined.
- HI2066**     **cast to function type is illegal**  
An object was cast to a function type, which is illegal.  
However, it is legal to cast an object to a function pointer.
- HI2067**     **cast to array type is illegal**  
An object was cast to an array type.
- HI2068**     **illegal cast**  
A type used in a cast operation was not legal for this expression.
- HI2069**     **cast of void term to nonvoid**  
The void type was cast to a different type.
- HI2070**     **illegal sizeof operand**  
The operand of a **sizeof** expression was not an identifier or a type name.
- HI2071**     *identifier : illegal storage class*  
The given storage class cannot be used in this context.
- HI2072**     *identifier : initialization of a function*  
An attempt was made to initialize a function.
- HI2043**     **illegal break**  
A break statement is legal only within a do, for, while, or switch statement.
- HI2044**     **illegal continue**  
A continue statement is legal only within a do, for, or while statement.
- HI2045**     *identifier : label redefined*  
The label appeared before more than one statement in the same function.
- HI2046**     **illegal case**  
The keyword case may appear only within a switch statement.
- HI2047**     **illegal default**  
The keyword default may appear only within a switch statement.
- HI2048**     **more than one default**  
A switch statement contained more than one default label.
- HI2049**     **case value *value* already used**  
The case value was already used in this switch statement.

- HI2050 nonintegral switch expression**  
A switch expression did not evaluate to an integral value.
- HI2051 case expression not constant**  
Case expressions must be integral constants.
- HI2052 case expression not integral**  
Case expressions must be integral constants.
- HI2054 expected '(' to follow *identifier***  
The context requires parentheses after the function identifier.  
One cause of this error is forgetting an equal sign (=) on a complex initialization, as in
- ```
int array1[] /* Missing = */
{
  1, 2, 3
};
```
- HI2055 expected formal-parameter list, not a type list**  
An argument-type list appeared in a function definition instead of a formal-parameter list.
- HI2075 *identifier* : array initialization needs curly braces**  
There were no curly braces, {}, around the given array initializer.
- HI2076 *identifier* : struct/union initialization needs curly braces**  
There were no curly braces, {}, around the given structure or union initializer.
- HI2077 nonscalar field initializer *identifier***  
An attempt was made to initialize a bit-field member of a structure with a nonscalar value.
- HI2078 too many initializers**  
The number of initializers exceeded the number of objects to be initialized.
- HI2079 *identifier* uses undefined struct/union *name***  
The *identifier* was declared as structure or union type name, but the *name* had not been defined. This error may also occur if an attempt is made to initialize an anonymous union.
- HI2080 illegal far *\_fastcall* function**  
A far *\_fastcall* function may not be compiled with the /Gw option, or with the /Gq option if stack checking is enabled.
- HI2082 redefinition of formal parameter *identifier***  
A formal parameter to a function was redeclared within the function body.
- HI2084 function *function* already has a body**  
The function has already been defined.



**HI2086** *identifier : redefinition*

The given identifier was defined more than once, or a subsequent declaration differed from a previous one.

The following are ways to cause this error:

```
int a;
char a;
main()
{
}
main()
{
int a;
int a;
}
```

However, the following does not cause this error:

```
int a;
int a;
main()
{
}
```

**HI2087** *identifier : missing subscript*

The definition of an array with multiple subscripts was missing a subscript value for a dimension other than the first dimension.

The following is an example of an illegal definition:

```
int func(a)
char a[10]{};
{ }
```

The following is an example of a legal definition:

```
int func(a)
char a[][5];
{ }
```

**HI2090** **function returns array**

A function cannot return an array. It can return a pointer to an array.

**HI2091** **function returns function**

A function cannot return a function. It can return a pointer to a function.

**HI2092** **array element type cannot be function**

Arrays of functions are not allowed. Arrays of pointers to functions are allowed.

- HI2095**     *function : actual has type void : parameter number*  
An attempt was made to pass a void argument to a function. The given number indicates which argument was in error.  
Formal parameters and arguments to functions cannot have type void. They can, however, have type void \* (pointer to void).
- HI2100**     **illegal indirection**  
The indirection operator (\*) was applied to a nonpointer value.
- HI2101**     **'&' on constant**  
The address-of operator (&) did not have an **lvalue** as its operand.
- HI2102**     **'&' requires lvalue**  
The address-of operator (&) must be applied to an **lvalue** expression.
- HI2103**     **'&' on register variable**  
An attempt was made to take the address of a register variable.
- HI2104**     **'&' on bit field ignored**  
An attempt was made to take the address of a bit field.
- HI2105**     *operator needs lvalue*  
The given operator did not have an **lvalue** operand.
- HI2106**     *operator : left operand must be lvalue*  
The left operand of the given operator was not an lvalue.
- HI2107**     **illegal index, indirection not allowed**  
A subscript was applied to an expression that did not evaluate to a pointer.
- HI2108**     **nonintegral index**  
A nonintegral expression was used in an array subscript.
- HI2109**     **subscript on nonarray**  
A subscript was used on a variable that was not an array.
- HI2110**     **pointer + pointer**  
An attempt was made to add one pointer to another using the plus (+) operator.
- HI2111**     **pointer + nonintegral value**  
An attempt was made to add a nonintegral value to a pointer.
- HI2112**     **illegal pointer subtraction**  
An attempt was made to subtract pointers that did not point to the same type.

- HI2113**     **pointer subtracted from nonpointer**  
The right operand in a subtraction operation using the minus (-) operator was a pointer, but the left operand was not.
- HI2114**     **operator : pointer on left; needs integral right**  
The left operand of the given operator was a pointer; so the right operand must be an integral value.
- HI2115**     **identifier : incompatible types**  
An expression contained incompatible types.
- HI2117**     **operator : illegal for struct/union**  
Structure and union type values are not allowed with the given operator.
- HI2118**     **negative subscript**  
A value defining an array size was negative.
- HI2120**     **void illegal with all types**  
The void type was used in a declaration with another type.
- HI2121**     **operator : bad left/right operand**  
The left or right operand of the given operator was illegal for that operator.
- HI2124**     **divide or mod by zero**  
A constant expression was evaluated and found to have a zero denominator.
- HI2128**     **identifier : huge array cannot be aligned to segment boundary**  
The given huge array was large enough to cross two segment boundaries, but could not be aligned to both boundaries to prevent an individual array element from crossing a boundary.  
  
If the size of a huge array causes it to cross two boundaries, the size of each array element must be a power of two, so that a whole number of elements will fit between two segment boundaries.
- HI2129**     **static function *function* not found**  
A forward reference was made to a static function that was never defined.
- HI2130**     **#line expected a string containing the file name, found *token***  
The optional token following the line number on a #line directive was not a string.
- HI2131**     **more than one memory attribute**  
More than one of the keywords **\_near**, **\_far**, **\_huge**, or **\_based** were applied to an item, as in the following example:
- ```
typedef int _near nint;  
nint _far a; /* Illegal */
```

- HI2132**     **syntax error : unexpected identifier**  
An identifier appeared in a syntactically illegal context.
- HI2133**     **identifier : unknown size**  
An attempt was made to declare an unsized array as a local variable.
- HI2134**     **identifier : struct/union too large**  
The size of a structure or union exceeded the 64K compiler limit.
- HI2136**     **function : prototype must have parameter types**  
A function prototype declarator had formal-parameter names, but no types were provided for the parameters.  
  
A formal parameter in a function prototype must either have a type or be represented by an ellipsis (...) to indicate a variable number of arguments and no type checking.  
  
One cause of this error is a misspelling of a type name in a prototype that does not provide the names of formal parameters.
- HI2137**     **empty character constant**  
The illegal empty-character constant ("") was used.
- HI2139**     **type following identifier is illegal**  
Two types were used in the same declaration.  
  
For example:  
  
`int double a;`
- HI2141**     **value out of range for enum constant**  
An enumeration constant had a value outside the range of values allowed for type int.
- HI2143**     **syntax error : missing *token1* before *token2***  
The compiler expected *token1* to appear before *token2*.  
  
This message may appear if a required closing brace (}), right parenthesis ()), or semicolon (;) is missing.
- HI2144**     **syntax error : missing *token* before type *type***  
The compiler expected the given token to appear before the given type name.  
  
This message may appear if a required closing brace (}), right parenthesis ()), or semicolon (;) is missing.
- HI2145**     **syntax error : missing *token* before identifier**  
The compiler expected the given token to appear before an identifier.  
  
This message may appear if a semicolon (;) does not appear after the last declaration of a block.

- HI2146**     **syntax error : missing *token* before identifier *identifier***  
The compiler expected the given token to appear before the given identifier.
- HI2147**     **unknown size**  
An attempt was made to increment an index or pointer to an array whose base type has not yet been declared.
- HI2148**     **array too large**  
An array exceeded the maximum legal size of 64K.  
Either reduce the size of the array, or declare it with **`_huge`**.
- HI2149**     ***identifier* : named bit field cannot have 0 width**  
The given named bit field had zero width. Only unnamed bit fields are allowed to have zero width.
- HI2150**     ***identifier* : bit field must have type int, signed int, or unsigned int**  
The ANSI C standard requires bit fields to have types of int, signed int, or unsigned int. This message appears only when compiling with the `/Za` option.
- HI2151**     **more than one language attribute**  
More than one keyword specifying a calling convention for a function was given.
- HI2152**     ***identifier* : pointers to functions with different attributes**  
An attempt was made to assign a pointer to a function declared with one calling convention (**`_cdecl`**, **`_fortran`**, **`_pascal`**, or **`_fastcall`**) to a pointer to a function declared with a different calling convention.
- HI2153**     **hex constants must have at least 1 hex digit**  
The hexadecimal constants `0x`, `0X` and `\x` are illegal. At least one hexadecimal digit must follow the `x` or `X`.
- HI2154**     ***segment* : does not refer to a segment name**  
A **`_based`**-allocated variable must be allocated in a segment unless it is extern and uninitialized.
- HI2156**     **pragma must be outside function**  
A pragma that must be specified at a global level, outside a function body, occurred within a function.

For example, the following causes this error:

```
main()
{
#pragma optimize("l", on)
}
```

- HI2157**     *function* : **must be declared before use in pragma list**  
The function name in the list of functions for an **alloc\_text** pragma has not been declared prior to being referenced in the list.
- HI2158**     *identifier* : **is a function**  
The given identifier was specified in the list of variables in a **same\_seg** pragma but was previously declared as a function.
- HI2159**     **more than one storage class specified**  
A declaration contained more than one storage class, as in  

```
extern static int i;
```
- HI2160**     **## cannot occur at the beginning of a macro definition**  
A macro definition began with a token-pasting operator (**##**), as in  

```
#define mac(a,b) ##a
```
- HI2161**     **## cannot occur at the end of a macro definition**  
A macro definition ended with a token-pasting operator (**##**), as in  

```
#define mac(a,b) a##
```
- HI2162**     **expected macro formal parameter**  
The token following a stringizing operator (**#**) was not a formal-parameter name.  
For example:  

```
#define print(a) printf(#b)
```
- HI2165**     *keyword* : **cannot modify pointers to data**  
The **\_fortran**, **\_pascal**, **\_cdecl**, or **\_fastcall** keyword was used illegally to modify a pointer to data, as in the following example:  

```
char _pascal *p;
```
- HI2166**     **lvalue specifies const object**  
An attempt was made to modify an item declared with const type.
- HI2167**     *function* : **too many actual parameters for intrinsic function**  
A reference to the intrinsic function name contained too many actual parameters.
- HI2168**     *function* : **too few actual parameters for intrinsic function**  
A reference to the intrinsic function name contained too few actual parameters.

**HI2171** *operator : illegal operand*

The given unary operator was used with an illegal operand type, as in the following example:

```
int (*fp)();  
double d,d1;  
fp++;  
d = ~d1;
```

**HI2172** *function : actual is not a pointer : parameter number*

An attempt was made to pass an argument that was not a pointer to a function that expected a pointer. The given number indicates which argument was in error.

**HI2173** *function : actual is not a pointer : parameter number1, parameter list number2*

An attempt was made to pass a nonpointer argument to a function that expected a pointer.

This error occurs in calls that return a pointer to a function. The first number indicates which argument was in error; the second number indicates which argument list contained the invalid argument.

**HI2174** *function : actual has type void : parameter number1, parameter list number2*

An attempt was made to pass a void argument to a function. Formal parameters and arguments to functions cannot have type void. They can, however, have type void \* (pointer to void).

This error occurs in calls that return a pointer to a function. The first number indicates which argument was in error; the second number indicates which argument list contained the invalid argument.

**HI2177** **constant too big**

Information was lost because a constant value was too large to be represented in the type to which it was assigned.

**HI2178** *identifier : storage class for same\_seg variables must be extern*

The given variable was specified in a **same\_seg** pragma, but it was not declared with extern storage class.

**HI2179** *identifier : was used in same\_seg, but storage class is no longer extern*

The given variable was specified in a **same\_seg** pragma, but it was redeclared with a storage class other than extern.

**HI2185** *identifier* : illegal **\_based** allocation

A **\_based**-allocated variable that explicitly has extern storage class and is uninitialized may not have a base of any of the following:

```
(_segment) & var  
_segname ("_STACK")  
(_segment)_self  
void
```

If the variable does not explicitly have extern storage class or it is uninitialized, then its base must use **\_segname**("string") where *string* is any segment name or reserved segment name except "\_STACK".

**HI2187** **cast of near function pointer to far function pointer**

An attempt was made to cast a near function pointer as a far function pointer.

**HI2189** **#error** : *string*

An **#error** directive was encountered. The *string* is the descriptive text supplied in the directive.

**HI2193** *identifier* : **already in a segment**

A variable in the **same\_seg** pragma has already been allocated in a segment, using **\_based**.

**HI2194** *segment* : **is a text segment**

The given text segment was used where a data, const, or bss segment was expected.

**HI2195** *segment* : **is a data segment**

The given data segment was used where a text segment was expected.

**HI2200** *function* : **function has already been defined**

A function name passed as an argument in an **alloc\_text** pragma has already been defined.

**HI2201** *function* : **storage class must be extern**

A function declaration appears within a block, but the function is not declared extern. This causes an error if the **/Za** option is in effect.

For example, the following causes this error, when compiled with **/Za**:

```
main()  
{  
    static int func1();  
}
```

**HI2205** *identifier* : **cannot initialize extern block-scoped variables**

A variable with extern storage class may not be initialized in a function.



- HI2208 no members defined using this type**  
An **enum**, **struct**, or **union** was defined without any members. This is an error only when compiling with /Za; otherwise, it is a warning.
- HI2209 type cast in \_based construct must be (\_segment)**  
The only type allowed within a cast in a **\_based** declarator is **(\_segment)**.
- HI2210 identifier : must be near/far data pointer**  
The base in a **\_based** declarator must not be an array, a function, or a **\_based** pointer.
- HI2211 (\_segment) applied to function identifier *function***  
The item cast in a **\_based** declarator must not be a function.
- HI2212 identifier : \_based not available for functions/pointers to functions**  
Functions cannot be **\_based**-allocated. Use the **alloc\_text** pragma.
- HI2213 identifier : illegal argument to \_based**  
A symbol used as a base must have type **\_segment** or be a near or far pointer.
- HI2214 pointers based on void require the use of :>**  
A **\_based** pointer based on void cannot be dereferenced. Use the **:>** operator to create an address that can be dereferenced.
- HI2215 :> operator only for objects based on void**  
The right operand of the **:>** operator must be a pointer based on void, as in  

```
char _based(void) *cbvpi
```
- HI2216 attribute1 may not be used with attribute2**  
The given function attributes are incompatible.  
Some combinations of attributes that cause this error are
- ◆ **\_saveregs** and **\_interrupt**
  - ◆ **\_fastcall** and **\_saveregs**
  - ◆ **\_fastcall** and **\_interrupt**
  - ◆ **\_fastcall** and **\_export**

- HI2217**     *attribute1 must be used with attribute2*  
The first function attribute requires the second attribute to be used.  
Some causes for this error include
- ◆ An interrupt function explicitly declared as near. Interrupt functions must be far.
  - ◆ An interrupt function or a function with a variable number of arguments, when that function is declared with the **\_fortran**, **\_pascal**, or **\_fastcall** attribute. Functions declared with the **\_interrupt** attribute or with a variable number of arguments must use the C calling conventions. Remove the **\_fortran**, **\_pascal**, or **\_fastcall** attribute from the function declaration.
- HI2218**     **type in \_based construct must be void**  
The only type allowed within a **\_based** construct is void.
- HI2219**     **syntax error : type qualifier must be after '\*'**  
Either const or volatile appeared where a type or qualifier is not allowed, as in  

```
int (const *p);
```
- HI2220**     **warning treated as error - no object file generated**  
When the compiler option /WX is used, the first warning generated by the compiler causes this error message to be displayed.  
Either correct the condition that caused the warning, or compile at a lower warning level or without /WX.
- HI2221**     **'!' : left operand points to struct/union, use '->'**  
The left operand of the '!' operator must be a **struct/union** type. It cannot be a pointer to a **struct/union** type.  
This error usually means that a -> operator must be used.
- HI2222**     **-> : left operand has struct/union type, use '.'**  
The left operand of the -> operator must be a pointer to a **struct/union** type. It cannot be a **struct/union** type.  
This error usually means that a '!' operator must be used.
- HI2223**     **left of ->member must point to struct/union**  
The left operand of the -> operator is not a pointer to a **struct/union** type.  
This error can occur when the left operand is an undefined variable. Undefined variables have type **int**.

- HI2224**    **left of *.member* must have struct/union type**  
The left operand of the '**!**' operator is not a **struct/union** type.  
This error can occur when the left operand is an undefined variable. Undefined variables have type **int**.
- HI2225**    ***tagname* : first member of struct is unnamed**  
The **struct** with the given tag started with an unnamed member (an alignment member). **Struct** definitions must start with a named member.

## H2INC Warnings

- HI4000**    **UNKNOWN WARNING Contact Microsoft Product Support Services**  
(level 1)    The compiler detected an unknown error condition.  
  
Note the circumstances of the error and notify Microsoft Corporation by following the instructions in the "Microsoft Support Services" section of the introduction to this book.
- HI4001**    **nonstandard extension used - *extension***  
(level 1, 4)    The given nonstandard language extension was used when the **/Ze** option was specified.  
  
This is a level 4 warning, except in the case of a function pointer cast to data when the Quick Compile option, **/qc**, is in use, which produces a level 1 warning.  
  
If the **/Za** option has been specified, this condition generates a syntax error.
- HI4002**    **too many actual parameters for macro *identifier***  
(level 1)    The number of actual arguments specified with the given identifier was greater than the number of formal parameters given in the macro definition of the identifier.  
  
The additional actual parameters are collected but ignored during expansion of the macro.
- HI4003**    **not enough actual parameters for macro *identifier***  
(level 1)    The number of actual arguments specified with the given identifier was less than the number of formal parameters given in the macro definition of the identifier.  
  
When a formal parameter is referenced in the definition and the corresponding actual parameter has not been provided, empty text is substituted in the macro expansion.

**HI4004**     **missing ')' after *defined*****(level 1)**

The closing parenthesis was missing from an **#if** defined phrase.

The compiler assumes a right parenthesis, ), after the first identifier it finds. It then attempts to compile the remainder of the line, which may result in another warning or error.

The following example causes this warning and a fatal error:

```
#if defined( ID1 ) || ( ID2 )
```

The compiler assumed a right parenthesis after ID1, then found a mismatched parenthesis in the remainder of the line. The following avoids this problem:

```
#if defined( ID1 ) || defined( ID2 )
```

**HI4005**     ***identifier* : macro redefinition****(level 1)**

The given identifier was defined twice. The compiler assumed the new macro definition.

To eliminate the warning, either remove one of the definitions or use an **#undef** directive before the second definition.

This warning is caused in situations where a macro is defined both on the command line and in the code with a **#define** directive.

**HI4006**     **#undef expected an identifier****(level 1)**

The name of the identifier whose definition was to be removed was not given with the **#undef** directive. The **#undef** was ignored.

**HI4007**     ***identifier* : must be attribute****(level 2)**

The attribute of the given function was not explicitly stated. The compiler forced the attribute.

For example, the function main must have the **\_cdecl** attribute.

**HI4008**     ***identifier* : \_fastcall attribute on data ignored****(level 2)**

The **\_fastcall** attribute on the given data identifier was ignored.

**HI4009**     **string too big, trailing characters truncated****(level 1)**

A string exceeded the compiler limit of 2047 on string size. The excess characters at the end of the string were truncated.

To correct this problem, break the string into two or more strings.

- HI4010**      **identifier is a MASM keyword**  
(level 1)      This warning is issued if the .h include file tries to redefine a MASM keyword.
- H2INC will give a warning whenever such conflicts take place. This includes **#define**, **typedef**, structures, and other variables. If you want to redefine a MASM keyword, use **#define** instead. A **#define** in the .INC file will not try to redefine the MASM keyword unless the /Ht option is set.
- This warning will also be issued anytime converting a **typedef** statement will result in a type with the same name as the type. The translation is not done in this case. For more information on warning HI4010, see "Miscellaneous Utilities."
- HI4011**      **identifier truncated to *identifier***  
(level 1)      Only the first 31 characters of an identifier are significant. The characters after the limit were truncated.
- This may mean that two identifiers that are different before truncation may have the same identifier name after truncation.
- HI4015**      ***identifier* : bit-field type must be integral**  
(level 1)      The given bit field was not declared as an integral type. The compiler assumed the base type of the bit field to be unsigned.
- Bit fields must be declared as unsigned integral types.
- HI4016**      ***function* : no function return type, using int as default**  
(level 3)      The given function had not yet been declared or defined, so the return type was unknown. A default return type of **int** was assumed.
- HI4017**      **cast of int expression to far pointer**  
(level 1)      A far pointer represents a full segmented address. On an 8086/8088 processor, casting an **int** value to a far pointer may produce an address with a meaningless segment value.
- The compiler extended the **int** expression to a 4-byte value.
- HI4020**      ***function* : too many actual parameters**  
(level 1)      The number of arguments specified in a function call was greater than the number of parameters specified in the function prototype or function definition.
- The extra parameters were passed according to the calling convention used on the function.
- HI4021**      ***function* : too few actual parameters**  
(level 1)      The number of arguments specified in a function call was less than the number of parameters specified in the function prototype or function definition.
- Only the provided actual parameters are passed. If the called function references a variable that was not passed, the results are undefined and may be unexpected.

- HI4022**      *function : pointer mismatch : parameter number*  
(level 1)      The pointer type of the given parameter was different from the pointer type specified in the argument-type list or function definition.  
  
The parameter will be passed without change. Its value will be interpreted as a pointer within the called function.
- HI4023**      *function : **\_based** pointer passed to unprototyped function : parameter number*  
(level 1)      When in a near data model, only the offset portion of a **\_based** pointer is passed to an unprototyped function. If the function expects a far pointer, the resulting code will be wrong. In any data model, if the function is defined to take a **\_based** pointer with a different base, the resulting code may be unpredictable.  
  
If a prototype is used before the call, the call will be generated correctly.
- HI4024**      *function : different types : parameter number*  
(level 1)      The type of the given parameter in a function call did not agree with the type given in the argument-type list or function definition.  
  
The parameter will be passed without change. The function will interpret the parameter's type as the type expected by the function.
- HI4028**      **parameter number declaration different**  
(level 1)      The type of the given parameter did not agree with the corresponding type in the argument-type list or with the corresponding formal parameter.  
  
The original declaration was used.
- HI4030**      **first parameter list longer than the second**  
(level 1)      A function was declared more than once with different parameter lists.  
  
The first declaration was used.
- HI4031**      **second parameter list is longer than the first**  
(level 1)      A function was declared more than once with different parameter lists.  
  
The first declaration was used.
- HI4034**      **sizeof returns 0**  
(level 1)      The **sizeof** operator was applied to an operand that yielded a size of zero.  
  
This warning is informational.
- HI4040**      **memory attribute on identifier ignored**  
(level 1)      The **\_near**, **\_far**, **\_huge**, or **\_based** keyword has no effect in the declaration of the given identifier and is ignored.  
  
One cause of this warning is a huge array that is not declared globally. Declare huge arrays outside of main.

**HI4042** *identifier* : has bad storage class

(level 1)

The storage class specified for *identifier* cannot be used in this context.

The default storage class for this context was used in place of the illegal class:

- ◆ If *identifier* was a function, the compiler assumed extern class.
- ◆ If *identifier* was a formal parameter or local variable, the compiler assumed auto class.
- ◆ If *identifier* was a global variable, the compiler assumed the variable was declared with no storage class.

**HI4044** `_huge` on *identifier* ignored, must be an array

(level 1)

The compiler ignored the `_huge` memory attribute on the given identifier. Only arrays may be declared with the `_huge` memory attribute. On pointers, `_huge` must be used as a modifier, not as a memory attribute.

**HI4047** *operator* : different levels of indirection

(level 1)

An expression involving the specified operator had inconsistent levels of indirection.

If both operands are of arithmetic type, or if both are not (such as array or pointer), then they are used without change, though the compiler may DS-extend one of the operands if one is far and one is near. If one is arithmetic and one is not, the arithmetic operator is converted to the type of the other operator.

For example, the following code causes this warning but is compiled without change:

```
char **p;
char *q;
p = q;    /* Warning */
```

**HI4048** array's declared subscripts different

(level 1)

An expression involved pointers to arrays of different size.

The pointers were used without conversion.

**HI4049** *operator* : indirection to different types

(level 1)

The pointer expressions used with the given operator had different base types.

The expressions were used without conversion.

For example, the following code causes this warning:

```
struct ts1 *s1;
struct ts2 *s2;
s2 = s1;    /* Warning */
```

- HI4050**     *operator* : **different code attributes**  
(level 4)     The function-pointer expressions used with *operator* had different code attributes. The attribute involved is either **\_export** or **\_loadds**.
- This is a warning and not an error, because **\_export** and **\_loadds** affect only entry sequences and not calling conventions.
- HI4051**     **type conversion, possible loss of data**  
(level 2)     Two data items in an expression had different base types, causing the type of one item to be converted. During the conversion, a data item was truncated.
- HI4052**     **invalid numerical argument** *string*  
A numerical argument was expected instead of the given string.
- HI4053**     **at least one void operand**  
(level 1)     An expression with type void was used as an operand.  
The expression was evaluated using an undefined value for the void operand.
- HI4063**     *function* : **function too large for post-optimizer**  
(level 2)     Not enough space was available to optimize the given function.  
One of the following may be a solution:
- ◆ Recompile with fewer optimizations.
  - ◆ Divide the function into two or more smaller functions.
- HI4066**     **local symbol-table overflow - some local symbols may be missing in listings**  
(level 2)     The listing generator ran out of heap space for local variables, so the source listing may not contain symbol-table information for all local variables.
- HI4067**     **unexpected characters following** *directive* **directive - newline expected**  
(level 1)     Extra characters followed a preprocessor directive and were ignored. This warning appears only when compiling with the */Za* option.  
For example, the following code causes this warning:
- ```
#endif     NO_EXT_KEYS
```
- To remove the warning, compile with */Ze* or use comment delimiters:
- ```
#endif     /* NO_EXT_KEYS */
```
- HI4071**     *function* : **no function prototype given**  
(level 2)     The given function was called before the compiler found the corresponding function prototype.  
The function will be called using the default rules for calling a function without a prototype.



- HI4072**     *function : no function prototype on \_fastcall function*  
(level 1)     A **\_fastcall** function was called without first being prototyped.  
Functions that are **\_fastcall** should be prototyped to guarantee that the registers assigned at each point of call are the same as the registers assumed when the function is defined. A function defined in the new ANSI style is a prototype.  
A prototype must be added when this warning appears, unless the function takes no arguments or takes only arguments that cannot be passed in the general-purpose registers.
- HI4073**     **scoping too deep, deepest scoping merged when debugging**  
(level 1)     Declarations appeared at a static nesting level greater than 13. As a result, all declarations beyond this level will seem to appear at the same level.
- HI4076**     *type : may be used on integral types only*  
(level 1)     The signed or unsigned type modifier was used with a nonintegral type.  
The given qualifier was ignored.  
The following example causes this warning:  

```
unsigned double x;
```
- HI4079**     **unexpected token** *token*  
(level 1)     An unexpected separator token was found in the argument list of a pragma.  
The remainder of the pragma was ignored.
- HI4082**     **expected an identifier, found** *token*  
(level 1)     An identifier was missing from the argument list.  
The remainder of the pragma was ignored.
- HI4083**     **expected '(', found** *token*  
(level 1)     A left parenthesis, (, was missing from a pragma's argument list.  
The pragma was ignored.  
The following example causes this warning:  

```
#pragma check_pointer on)
```
- HI4084**     **expected a pragma keyword, found** *token*  
(level 1)     The *token* following **#pragma** was not recognized as a directive.  
The pragma was ignored.  
The following example causes this warning:  

```
#pragma (on)
```

**HI4085 expected [on | off]**

(level 1) The pragma expected an on or off parameter, but the specified parameter was unrecognized or missing.

The pragma was ignored.

**HI4086 expected [1 | 2 | 4]**

(level 1) The pragma expected a parameter of either 1, 2, or 4, but the specified parameter was unrecognized or missing.

**HI4087 function : declared with void parameter list**

(level 1) The given function was declared as taking no parameters, but a call to the function specified actual parameters.

The extra parameters were passed according to the calling convention used on the function.

The following example causes this warning:

```
int f1(void);  
f1(10);
```

**HI4088 function : pointer mismatch : parameter number, parameter list number**

(level 1) The argument passed to the given function had a different level of indirection from the given parameter in the function definition.

The parameter will be passed without change. Its value will be interpreted as a pointer within the called function.

**HI4089 function : different types : parameter number, parameter list number**

(level 1) The argument passed to the given function did not have the same type as the given parameter in the function definition.

The parameter will be passed without change. The function will interpret the parameter's type as the type expected by the function.

**HI4090 different const/volatile qualifiers**

(level 1) A pointer to an item declared as const was assigned to a pointer that was not declared as const. As a result, the const item pointed to could be modified without being detected.

The expression was compiled without modification.

The following example causes this warning:

```
const char *p = "abcde";  
int str(char *s);  
str(p);
```

**HI4091 no symbols were declared****(level 2)**

The compiler detected an empty declaration, as in the following example:

```
int ;
```

The declaration was ignored.

**HI4092 untagged enum/struct/union declared no symbols****(level 2)**

The compiler detected an empty declaration using an untagged structure, union, or enumerated variable.

The declaration was ignored.

For example, the following code causes this warning:

```
struct { . . . };
```

**HI4093 unescaped newline in character constant in inactive code****(level 3)**

The constant expression of an **#if**, **#elif**, **#ifdef**, or **#ifndef** preprocessor directive evaluated to 0, making the code that follows inactive. Within that inactive code, a newline character appeared within a set of single or double quotation marks.

All text until the next double quotation mark was considered to be within a character constant.

**HI4095 expected ')', found *token*****(level 1)**

More than one argument was given for a pragma that can take only one argument.

The compiler assumed the expected parenthesis and ignored the remainder of the line.

**HI4096 *attribute1* must be used with *attribute2*****(level 2)**

The use of *attribute2* requires the use of *attribute1*.

For example, using a variable number of arguments (...) requires that **\_cdecl** be used. Also, **\_interrupt** functions must be **\_far** and **\_cdecl**.

The compiler assumed *attribute1* for the function.

**HI4098 void function returning a value****(level 1)**

A function declared with a void return type also returned a value.

A function was declared with a void return type but was defined as a value.

The compiler assumed the function returns a value of type int.

**HI4104 *identifier* : near data in same\_seg pragma, ignored****(level 1)**

The given near variable was specified in a **same\_seg** pragma.

The *identifier* was ignored.

- HI4105**     *identifier* : **code modifiers only on function or pointer to function**  
(level 1)    The given identifier was declared with a code modifier that can be used only with a function or function pointer.  
              The code modifier was ignored.
- HI4109**     **unexpected identifier** *identifier*  
(level 1)    The pragma contained an unexpected token.  
              The pragma was ignored.
- HI4110**     **unexpected token** *int constant*  
(level 1)    The pragma contained an unexpected integer constant.  
              The pragma was ignored.
- HI4111**     **unexpected token** *string*  
(level 1)    The pragma contained an unexpected string.  
              The pragma was ignored.
- HI4112**     **macro name *name* is reserved, *command* ignored**  
(level 1)    The given command attempted to define or undefine the predefined macro *name* or the preprocessor operator *defined*. The given command is displayed as either **#define** or **#undef**, even if the attempt was made using command-line options.  
              The command was ignored.
- HI4113**     **function parameter lists differed**  
(level 1)    A function pointer was assigned to a function pointer, but the parameter lists of the functions do not agree.  
              The expression was compiled without modification.
- HI4114**     **same type qualifier used more than once**  
(level 1)    A type qualifier (const, volatile, signed, or unsigned) was used more than once in the same type.  
              The second occurrence of the qualifier was ignored.
- HI4115**     ***tag* : type definition in formal parameter list**  
(level 1)    The given tag was used to define a **struct**, **union**, or **enum** in the formal parameter list of a function.  
              The compiler assumed the definition was at the global level.
- HI4116**     **(no tag) : type definition in formal parameter list**  
(level 1)    A **struct**, **union**, or **enum** type with no tag was defined in the formal parameter list of a function.  
              The compiler assumed the definition was at the global level.

**HI4119**     **different bases *name1* and *name2* specified**

(level 1)     The **\_based** pointers in the expression have different symbolic bases. There may be truncation or loss in the code generated.

**HI4120**     **\_based/unbased mismatch**

(level 1)     The expression contains a conversion between a **\_based** pointer and another pointer that is unbased. Some information may have been truncated.

This warning commonly occurs when a **\_based** pointer is passed to a function that accepts a near or far pointer.

**HI4123**     **different base expressions specified**

(level 1)     The expression contains a conversion between **\_based** pointers, but the base expressions of the **\_based** pointers are different. Some of the **\_based** conversions may be unexpected.

**HI4125**     **decimal digit terminates octal escape sequence**

(level 4)     An octal escape sequence in a character or string constant was terminated with a decimal digit.

The compiler evaluated the octal number without the decimal digit, and assumed the decimal digit was a character.

The following example causes this warning:

```
char array1[] = "\709";
```

If the digit 9 was intended as a character and was not a typing error, correct the example as follows:

```
char array[] = "\0709"; /* String containing "89" */
```

**HI4126**     ***flag* : unknown memory model flag**

(level 1)     The flag used with the /A option was not recognized and was ignored.

**HI4128**     **storage-class specifier after type**

(level 4)     A storage-class specifier (auto, extern, register, static) appears after a type in a declaration. The compiler assumed the storage class specifier occurred before the type.

New-style code places the storage-class specifier first.

**HI4129**     ***character* : unrecognized character escape sequence**

(level 4)     The *character* following a backslash in a character or string constant was not recognized as a valid escape sequence.

As a result, the backslash is ignored and not printed, and the character following the backslash is printed.

To print a single backslash (\), specify a double backslash (\\).

**HI4130**     *operator : logical operation on address of string constant*

**(level 4)**     The operator was used with the address of a string literal. Unexpected code was generated.

For example, the following code causes this warning:

```
char *pc;  
pc = "Hello";  
if (pc == "Hello") ...
```

The if statement compares the value stored in the pointer *pc* to the address of the string "Hello" which is separately allocated each time it occurs in the code. It does not compare the string pointed to by *pc* with the string "Hello."

To compare strings, use the *strcmp* function.

**HI4131**     *function : uses old-style declarator*

**(level 4)**     The function declaration or definition is not a prototype.

New-style function declarations are in prototype form.

## ◆ old style

```
int addrec( name, id )  
char *name;  
int id;  
{ }
```

## ◆ new style

```
int addrec( char *name, int id )  
{ }
```

**HI4132**     *object : const object should be initialized*

**(level 4)**     The value of a const object cannot be changed, so the only way to give the const object a value is to initialize it.

It will not be possible to assign a value to *object*.

**HI4135**     *conversion between different integral types*

**(level 3)**     Information was lost between two integral types.

For example, the following code causes this warning:

```
int intvar;  
long longvar;  
intvar = longvar;
```

If the information is merely interpreted differently, this warning is not given, as in the following example:

```
unsigned uintvar = intvar;
```

**HI4136 conversion between different floating types****(level 4)**

Information was lost or truncated between two floating types.

For example, the following code causes this warning:

```
double doublevar;  
float floatvar;  
floatvar = doublevar;
```

Note that unsuffixed floating-point constants have type double, so the following code causes this warning:

```
floatvar = 1.0;
```

If the floating-point constant should be treated as float type, use the F (or f) suffix on the constant to prevent the following warning:

```
floatvar = 1.0F;
```

**HI4138 \*/ found outside of comment****(level 1)**

The compiler found a closing comment delimiter (\*/) without a preceding opening delimiter. It assumed a space between the asterisk (\*) and the forward slash (/).

The following example causes this warning:

```
int */comment*/ptr;
```

In this example, the compiler assumed a space before the first comment delimiter (/\*), and issued the warning but compiled the line normally. To remove the warning, insert the assumed space.

Usually, the cause of this warning is an attempt to nest comments.

To comment out sections of code that may contain comments, enclose the code in an **#if/#endif** block and set the controlling expression to zero, as in:

```
#if 0  
int my_variable; /* Declaration currently not needed */  
#endif
```

**HI4139**     *hexnumber* : hex escape sequence is out of range**(level 1)**

A hex escape sequence appearing in a character or string constant was too large to be converted to a character.

If in a string constant, the compiler cast the low byte of the hexadecimal number to a char. If in a char constant, the compiler made the cast and then sign extended the result. If in a char constant and compiled with */J*, the compiler cast the value to an unsigned char.

For example, '\x1ff' is out of range for a character. Note that the following code causes this warning:

```
printf("\x7Bell\n");
```

The number 7be is a legal hex number, but is too large for a character. To correct this example, use three hex digits:

```
printf("\x007Bell\n");
```

**HI4186**     **string too long - truncated to 40 characters****(level 1)**

The string argument for a title or subtitle pragma exceeded the maximum allowable length and was truncated.

**HI4200**     **local variable *identifier* used without having been initialized****(level 1)**

A reference was made to a local variable that had not been assigned a value. As a result, the value of the variable is unpredictable.

This warning is given only when compiling with global register allocation on (*/Oe*).

**HI4201**     **local variable *identifier* may be used without having been initialized****(level 3)**

A reference was made to a local variable that might not have been assigned a value. As a result, the value of the variable may be unpredictable.

This warning is given only when compiling with the global register allocation on (*/Oe*).

**HI4202**     **unreachable code****(level 4)**

The flow of control can never reach the indicated line.

This warning is given only when compiling with one of the global optimizations (*/Oe*, */Og*, or */Ol*).

**HI4203**     ***function* : function too large for global optimizations****(level 1)**

The named function was too large to fit in memory and be compiled with the selected optimization. The compiler did not perform any global optimizations (*/Oe*, */Og*, or */Ol*). Other */O* optimizations, such as */Oa* and */Oi*, are still performed.

One of the following may remove this warning:

- ◆ Recompile with fewer optimizations.
- ◆ Divide the function into two or more smaller functions.



**HI4204** *function* : in-line assembler precludes global optimizations

(level 3) The use of in-line assembler in the named function prevented the specified global optimizations (/Oe, /Og, or /Ol) from being performed.

**HI4205** **statement has no effect**

(level 4) The indicated statement will have no effect on the program execution.

Some examples of statements with no effect:

```
l;  
a + 1;  
b == c;
```

**HI4209** **comma operator within array index expression**

(level 4) The value used as an index into an array was the last one of multiple expressions separated by the comma operator.

An array index legally may be the value of the last expression in a series of expressions separated by the comma operator. However, the intent may have been to use the expressions to specify multiple indexes into a multidimensional array.

For example, the following line, which causes this warning, is legal in C, and specifies the index c into array a:

```
a[b, c]
```

However, the following line uses both b and c as indexes into a two-dimensional array:

```
a[b][c]
```

**HI4300** **insufficient memory to process debugging information**

(level 2) The program was compiled with the /Zi option, but not enough memory was available to create the required debugging information.

One of the following may be a solution:

- ◆ Split the current file into two or more files and compile them separately.
- ◆ Remove other programs or drivers running in the system which could be consuming significant amounts of memory.

**HI4301** **loss of debugging information caused by optimization**

(level 2) Some optimizations, such as code motion, cause references to nested variables to be moved. The information about the level at which the variables are declared may be lost. As a result, all declarations will seem to be at nesting level 1.

- HI4323 (level 3) potential divide by 0**  
The second operand in a divide operation evaluated to zero at compile time, giving undefined results.  
The 0 operand may have been generated by the compiler, as in the following example:  

```
func1() { int i,j,k; i /= j && k; }
```
- HI4324 (level 3) potential mod by 0**  
The second operand in a remainder operation evaluated to zero at compile time, giving undefined results.
- HI4799 (level 1) unknown option *character in option***  
A command line option was specified that was not understood by H2INC, or the given character was not a valid letter for the option.  
For example, the following line:  

```
#pragma optimize("q", on)
```

  
causes the following warning:  

```
unknown option 'q' in '#pragma optimize'
```
- HI4800 (level 1) more than one memory model specified**  
There was more than one memory model given at the command line. The /AT, /AS, /AM, /AC, /AL, and /AH options specify the memory model.  
This error is caused by conflicting options specified at the command line and in the CL and H2INC environment variables.
- HI4801 (level 1) more than one target processor specified**  
There was more than one processor type given at the command line. The /G0, /G1, and /G2 options specify the processor type.  
This error is caused by conflicting options specified at the command line and in the CL and H2INC environment variables.
- HI4802 (level 1) ignoring invalid /Zp value *value***  
The alignment value specified to the /Zp option was not 1, 2, or 4. The default of 1 was assumed.
- HI4810 (level 2) untranslatable basic type size**  
H2INC could not translate the item to a MASM type.  
The C void type cannot be translated to a similar MASM type.
- HI4811 (level 1) static function prototype not translated**  
H2INC does not translate static items, as they are not visible outside the C source file.

- HI4812 (level 1) static variable declaration not accepted with /Mn switch**  
H2INC does not translate static items, as they are not visible outside the C source file.
- HI4815 (level 1) *string* : EQU string truncated to 254 characters**  
A **#define** statement exceeded 254 characters, the maximum length of a MASM **EQU** statement. The string was truncated.
- HI4816 (level 1) ignoring *\_fastcall* function definition**  
H2INC does not translate function declarations or prototypes with the **\_fastcall** attribute. The **\_fastcall** calling convention cannot be used directly with MASM. See the documentation with your C compiler for details on **\_fastcall**.
- HI4820 (level 1) ignoring function definition : *function()***  
H2INC translates header information only; it cannot convert program code. H2INC does not translate function bodies.

## HELPMAKE Error Messages

Microsoft Help File Maintenance Utility (HELPMAKE) generates the following error messages:

- ◆ Fatal Errors (H1xxx) cause HELPMAKE to stop execution. No output file is produced.
- ◆ Errors (H2xxx) do not prevent an output file from being produced, but parts of the conversion are not completed.
- ◆ Warnings (H4xxx) do not prevent an output file from being produced, but problems may exist in the output.

## HELPMAKE Fatal Error Messages

- H1000 /A requires character**  
The /A option requires an application-specific control character.  
The correct form is:

/Ac

where *c* is the control character.

**H1001 /E compression level must be numeric**

The /E option requires either no argument or a numeric value in the range 0–15.

The correct form is:

/En

where *n* specifies the amount of compression requested.

**H1002 multiple /O parameters specified**

Only one output file can be specified with the /O option.

**H1003 invalid /S file-type identifier**

The /S option was given an argument other than 1, 2, or 3.

The /S option requires specification of the type of input file. An invalid file-type identifier was specified.

The correct form is:

/Sn

where *n* specifies the format of the input file. Valid values are 1 (RTF), 2 (QuickHelp format), and 3 (minimally formatted ASCII).

**H1004 /S requires file-type identifier**

The /S option requires specification of the type of input file. There was no file-type identifier specified.

The correct form is:

/Sn

where *n* specifies the format of the input file. Valid values are 1 (RTF), 2 (QuickHelp format), and 3 (minimally formatted ASCII).

**H1005 /W fixed width invalid**

An invalid width was specified with the /W option. The valid range is 11–255.

**H1006 multiple /K parameters specified**

The option for specifying a keyword separator file, /K, was used more than once on the HELPMAKE command line.

Only one file containing separator characters can be specified.

**H1050 option invalid with /DS**

The /C, /L, and /O options for encoding are invalid with the /DS option for decoding.

**H1051 improper arguments for /D**

The /D option permits either no argument or an S or U argument. In addition, /D is invalid with the /C or /L option.

- H1052 encode requires /O option**  
Database encoding was requested without a specified output-file name for the operation.
- H1053 compression level exceeds 15**  
A value greater than 15 was specified with the /E option.  
The /E option requires either no argument or a numeric value in the range 0–15.  
The correct form is:  
`/En`  
where *n* specifies the amount of compression requested.
- H1097 no operation specified**  
The HELPMAKE command line did not contain an option for encoding, decoding, or Help.  
HELPMAKE requires the /E, /D, /H, or /? option.
- H1098 unrecognized option**  
An unrecognized name followed the option indicator.  
An option is specified by a forward slash (/) or a dash (–) and an option name.
- H1099 syntax error on command line**  
HELPMAKE cannot interpret the command line.
- H1100 cannot open file**  
One of the files specified on the HELPMAKE command line could not be found or created.
- H1101 error writing file**  
The output file could not be written, probably because the disk is full.
- H1102 no input file specified**  
In an encoding operation, no input Help text file was specified.
- H1103 no context strings found**  
No context strings were found in the input stream during encoding.  
Either the file is empty or the specified /S value does not correspond to the Help text formatting.
- H1104 no topic text found**  
No topic text was found in the Help text file.  
Either the file is empty or the specified /S value does not correspond to the Help text formatting.

**H1107 cannot overwrite input file**

The /DS option for splitting a concatenated Help file was specified, but the Help file contained a database with the same name as the Help file. It may be that the Help file is not a concatenated file and contains only one database, and the database has the same name as its physical Help file.

One of the following may be a solution:

- ◆ Rename the Help file so that the filename does not match any of the database names.
- ◆ Run HELPMAKE from a directory other than the one that holds the physical Help file. Since HELPMAKE creates the split files in the current directory, no filename conflict occurs.

**H1200 insufficient memory to allocate context buffer**

There was insufficient memory to run HELPMAKE.

HELPMAKE requires 256K free memory.

**H1201 insufficient memory to allocate utility buffer**

There was insufficient memory to run HELPMAKE.

HELPMAKE requires 256K free memory.

**H1250 not a valid compressed Help file**

The input file specified for a decompression operation is not a valid Help database file.

**H1251 cannot decompress locked Help file**

An attempt was made to decompress a Help database file that is locked.

A file is locked if the /L option is specified when the Help file is created.

**H1300 word too long in RTF processing**

A single word was longer than the specified format width (set by the /W option) or was found to be longer than 128 characters when HELPMAKE was reformatting a paragraph.

**H1302 attribute stack overflow processing RTF**

RTF attribute groups are nested too deeply. HELPMAKE supports a maximum of 50 levels of attribute-group nesting in RTF format.

**H1303 unknown RTF attribute**

An unknown RTF formatting command was found.

One of the following may have occurred:

- ◆ A new RTF attribute was used. HELPMAKE recognizes a set of attributes that were current at the time this version of HELPMAKE was created. It interprets some of the attributes and knows to ignore the others. Any RTF attribute defined after HELPMAKE was created is not known by HELPMAKE and will cause this error.
- ◆ The RTF file is corrupted.

**H1304 topic too large**

A topic exceeded the limit for the size of topics.

A single topic cannot exceed 64K.

**H1305 topic text without context string**

The source file contained topic text that was not preceded by a .context definition.

**H1900 internal virtual memory error**

This message indicates an internal HELPMAKE error.

Note the circumstances of the error and notify Microsoft Corporation by following the instructions in the "Microsoft Support Services" section of the introduction to this book.

**H1901 out of local memory**

This message indicates an internal HELPMAKE error.

Note the circumstances of the error and notify Microsoft Corporation by following the instructions in the "Microsoft Support Services" section of the introduction to this book.

**H1902 out of disk space for swap file**

The current drive or directory is full.

HELPMAKE uses a temporary swap file, written to the current drive and directory. The temporary file can grow to 1.5 times the size of the input files (for large Help files) and is not removed until the final Help file is completed.

**H1903 cannot open swap file**

HELPMAKE was unable to create its temporary swap file on the current drive and directory for one of the following reasons:

- ◆ The current drive or directory is full.
- ◆ The device cannot be written to.

**H1990 internal compression error**

This message indicates an internal HELPMAKE error.

Note the circumstances of the error and notify Microsoft Corporation by following the instructions in the "Microsoft Support Services" section of the introduction to this book.

## HELPMAKE Error Messages

**H2000 line too long, truncated**

A line exceeded the fixed width specified by the /W option or the default of 76 characters. HELPMAKE truncated the extra characters.

**H2001 duplicate context string**

A context string preceded more than one topic in a Help database. A context string can be associated with only one block of topic text.

**H2002 zero length hot spot**

A cross-reference was specified, but the word or anchored text associated with it was of zero length.

With no visible text to associate with the cross-reference, the hot spot will be inoperative. This error is issued as a warning and does not prevent the building of a Help file. However, some applications may not be able to use the resulting Help file correctly.

The following example will cause this error:

```
\a\vcross_reference\v
```

**H2003 unrecognized dot command**

A line in the source file contained a dot (.) in column 1, but it was not followed by a command recognized by HELPMAKE.

## HELPMAKE Warning Messages

**H4000 keyword compression analysis table size exceeded  
no further new words will be analyzed**

The maximum number (16,000) of unique keywords has been encountered during keyword compression. This happens only in very large Help files. No further keywords will be included in the analysis. HELPMAKE continues to analyze how frequently words occur that it has already encountered.

**H4002 reference to undefined local context**

A string specifying a local context was used in a cross-reference but was not defined in a .context statement.

A local context begins with an at sign (@). Each local context that is used must be defined in a .context statement in one of the input files to HELPMAKE.



**H4003 negative left indent**

Topic text in an RTF file was formatted with a left indent to a position to the left of column 1. HELPMAKE deleted all text preceding column 1.

## IMPLIB Error Messages

Microsoft Import Library Manager (IMPLIB) generates the following error messages:

- ◆ Fatal errors (IM16xx) cause IMPLIB to stop execution.
- ◆ Errors (IM26xx) prevent IMPLIB from creating an import library.
- ◆ Warnings (IM46xx) indicate possible problems in the output file being created.

## IMPLIB Fatal Error Messages

**IM1600 error writing to output file—*message***

IMPLIB could not create the import library for the given reason.

Probably the drive or directory where the import library is being created is full.

**IM1601 out of memory, near/far heap exhausted**

There was not enough room in memory for the heap needed by IMPLIB.

Increase the available memory. Some ways to do this include:

- ◆ Remove TSR (terminate-and-stay-resident) programs.
- ◆ Run IMPLIB outside of an NMAKE session.
- ◆ Run IMPLIB outside of a shell.

**IM1602 syntax error in module-definition file**

IMPLIB could not understand the contents of a .DEF input file.

**IM1603 *filename* : cannot create file—*message***

IMPLIB could not create the given file for the given reason.

One of the following may be a cause:

- ◆ The file already exists with a read-only attribute.
- ◆ There is insufficient disk space to create the file.
- ◆ The drive cannot be written to.

**IM1604** *filename* : **cannot open file**—*message*

IMPLIB could not find the specified module-definition (.DEF) file or dynamic-link library (DLL) for the given reason.

**IM1605** **too many nested include files in module-definition file**

A module-definition (.DEF) file contained an **INCLUDE** statement specifying a nested set of include files that exceeded the limit for nesting. The limit is 10 levels.

**IM1606** **missing or invalid include file name**

A syntax error occurred in an **INCLUDE** statement in a module-definition (.DEF) file.

One of the following may have occurred:

- ◆ A filename was not specified.
- ◆ More than one filename was specified.
- ◆ A long filename was specified without being enclosed in quotation marks or was enclosed in one single and one double quotation mark.

**IM1607** *extension* : **invalid extension for target library**

The given extension was specified for the import library.

An import library cannot be given a .DEF or .DLL extension.

**IM1608** **no .DLL or .DEF source file specified**

No input file was specified on the IMPLIB command line.

## IMPLIB Error Messages

**IM2601** *symbol* **multiply defined**

The given symbol was defined more than once in the input files.

**IM2602** **unexpected end of name table in DLL**

A dynamic-link library (DLL) specified to IMPLIB was corrupted.

**IM2603** *filename* : **invalid .DLL file**

IMPLIB did not recognize the given input file as a dynamic-link library (DLL).

## IMPLIB Warning Messages

**IM4600** *line number* **too long; truncated to 512 characters**

The given line in the module-definition (.DEF) file exceeded the limit on line length. IMPLIB ignored text after the first 512 characters.

**IM4601** **unrecognized option** *option*; **option ignored**

The given option was not a valid IMPLIB option. IMPLIB used the rest of the command line to try to build an import library.

## LIB Error Messages

This section lists error messages generated by the LIB utility.

Microsoft Library Manager (LIB) generates the following error messages:

- ◆ Fatal errors (U1150 through U1203) cause LIB to stop execution.
- ◆ Errors (U2152 through U2159) do not stop execution but prevent LIB from creating a library.
- ◆ Warnings (U4150 through U4158) indicate possible problems in the library being created.

### LIB Fatal Error Messages

**U1150**      **page size too small; use option /PAGE:n to increase it**

The page size of an input library was too small, indicating an invalid input .LIB file.

**U1151**      **syntax error : illegal file specification**

A command operator was not followed by a module name or filename.

One possible cause of this error is an option specified with a dash (-) instead of a forward slash (/).

**U1152**      **syntax error : option name missing**

A forward slash (/) appeared on the command line without an option name after it.

**U1153**      **syntax error : option value missing**

The /PAGE option was given without a value following it.

**U1154**      **unrecognized option**

An unrecognized name followed the option indicator (/).

An option is specified by a forward slash (/) and a name. The name can be specified by a legal abbreviation of the full name.

**U1155**      **syntax error : illegal input**

A specified command did not follow correct LIB syntax.

**U1156**      **syntax error**

A specified command did not follow correct LIB syntax.

**U1157 comma or newline missing**

A comma or newline character was expected in the command line but did not appear.

One cause of this error is an incorrectly placed comma, as in the following command line:

```
LIB math.lib, -mod1 +mod2;
```

The line must be entered as follows:

```
LIB math.lib -mod1 +mod2;
```

**U1158 terminator missing**

The last line of the response file supplied to LIB did not end with a newline character.

**U1161 cannot rename old library**

LIB could not rename the old library with a .BAK extension because the .BAK version already existed with read-only protection.

Change the protection attribute on the .BAK file.

**U1162 cannot reopen library**

The old library could not be reopened after it was renamed with a .BAK extension.

One of the following may have occurred:

- ◆ Another process deleted the file or changed it to read-only.
- ◆ The floppy disk containing the file was removed.
- ◆ A hard-disk error occurred.

**U1163 error writing to cross-reference file**

The disk or root directory was full.

Delete or move files to make space.

**U1164 name length exceeds 255 characters**

A filename specified on the command line exceeded the LIB limit of 255 characters. Reduce the number of characters in the name.

**U1170 too many symbols**

The number of symbols in all object files and libraries exceeded the capacity of the dictionary created by LIB.

Create two or more smaller libraries.

**U1171 insufficient memory**

LIB did not have enough memory to run.

Remove any shells or resident programs, or add more memory.

- U1172 no more virtual memory**  
The LIB session required more memory than the 1-megabyte limit imposed by LIB.  
Try using the /NOE option or reducing the number of object modules.
- U1173 internal failure**  
Note the circumstances of the error and notify Microsoft Corporation by following the instructions in the “Microsoft Support Services” section of the introduction to this book.
- U1174 mark : not allocated**  
Note the circumstances of the error and notify Microsoft Corporation by following the instructions in the “Microsoft Support Services” section of the introduction to this book.
- U1175 free : not allocated**  
Note the circumstances of the error and notify Microsoft Corporation by following the instructions in the “Microsoft Support Services” section of the introduction to this book.
- U1180 write to extract file failed**  
The disk or root directory was full.  
Delete or move files to make space.
- U1181 write to library file failed**  
The disk or root directory was full.  
Delete or move files to make space.
- U1182 *filename* : cannot create extract file**  
The disk or root directory was full, or the given extract file already existed with read-only protection.  
Make space on the disk or change the protection of the extract file.
- U1183 cannot open response file**  
The response file was not found.
- U1184 unexpected end-of-file on command input**  
An end-of-file character was received prematurely in response to a prompt.
- U1185 cannot create new library**  
The disk or root directory was full, or the library file already existed with read-only protection.  
Make space on the disk or change the protection of the library file.
- U1186 error writing to new library**  
The disk or root directory was full.  
Delete or move files to make space.

**U1187 cannot open temporary file VM.TMP**

The disk or root directory was full.

Delete or move files to make space.

**U1188 insufficient disk space for temporary file**

The library manager cannot write to the virtual memory.

Note the circumstances of the error and notify Microsoft Corporation by following the instructions in the “Microsoft Support Services” section of the introduction to this book.

**U1189 cannot read from temporary file**

The library manager cannot read the virtual memory.

Note the circumstances of the error and notify Microsoft Corporation by following the instructions in the “Microsoft Support Services” section of the introduction to this book.

**U1190 interrupted by user**

LIB was interrupted with either CTRL+C or CTRL+BREAK.

**U1191 *libraryname* : cannot write to read-only file**

Operations cannot be performed on the given library because it is marked as a read-only file.

Change the protection attribute on the library.

**U1200 *filename* : invalid library header**

The input library file had an invalid format.

Either it was not a library file or it was corrupted.

**U1203 *filename* : invalid object file near *location***

The given file was not a valid object file or was corrupted at the given location.

## LIB Error Messages

**U2152 *filename* : cannot create listing**

One of the following may have occurred:

- ◆ The directory or disk was full.
- ◆ The cross-reference-listing file already existed with read-only protection.

- U2155**     *module* : **module not in library; ignored**  
The specified module was not found in the input library.  
One cause of this error is a filename or directory containing a hyphen or dash (–). LIB interprets the dash as the operator for the delete command. This error occurs if you install a Microsoft language product in a directory that has a dash in its path, such as C:\MS-C. The SETUP program for a language calls LIB to create combined libraries, but the dash in the command line passed to LIB causes the library-building session to fail.  
Another possible cause of this error is an option specified with a dash (–) instead of a forward slash (/).
- U2157**     *filename* : **cannot access file**  
LIB was unable to open the specified file, probably because the file did not exist.  
Check the path and filename.
- U2158**     *library* : **invalid library header; file ignored**  
The given library had an incorrect format and was not combined.
- U2159**     *filename* : **invalid format (number); file ignored**  
The given file was not recognized as a XENIX archive and was not combined.

## LIB Warning Messages

- U4150**     *module* : **module redefinition ignored**  
A module was specified with the add operator (+) to be added to a library, but a module having that name was already in the library.  
One cause of this error is an incorrect specification of the replace operator (– +).
- U4151**     *symbol* : **symbol defined in module *module*; redefinition ignored**  
The given symbol was defined in more than one module.
- U4153**     *option* : *value* : **page size invalid; ignored**  
The argument specified with the /PAGE option was not valid for that option. The value must be an integer power of 2 between 16 and 32,768. LIB assumed an existing page size from a library that is being combined.
- U4155**     *modulename* : **module not in library**  
The given module specified with a command operator does not exist in the library.  
If the replacement command (– +) was specified, LIB added the file anyway. If the delete (–), copy (\*), or move (– \*) command was specified, LIB ignored the command.

**U4156** *library* : output-library specification ignored

A new library was created because the filename specified in the *oldlibrary* field did not exist. However, a filename was also specified in the *newlibrary* field. LIB ignored the *newlibrary* specification.

For example, both of the following command lines cause this error if PROJECT.LIB does not already exist:

```
LIB project.lib +one.obj, new.lst, project.lib
LIB project.lib +one.obj, new.lst, new.lib
```

**U4157** insufficient memory, extended dictionary not created

Insufficient memory prevented LIB from creating an extended dictionary.

The library is still valid, but the linker cannot take advantage of the extended dictionary to speed linking.

**U4158** internal error, extended dictionary not created

An internal error prevented LIB from creating an extended dictionary.

The library is still valid, but the linker cannot take advantage of the extended dictionary to speed linking.

## LINK Error Messages

Microsoft Segmented-Executable Linker (LINK) generates the following error messages:

- ◆ Fatal errors (L1xxx) cause LINK to stop execution.
- ◆ Errors (L2xxx) do not stop execution but might prevent LINK from creating the main output file.
- ◆ Warnings (L4xxx) indicate possible problems in the output file being created.



## LINK Fatal Error Messages

**L1001**     *option* : **option name ambiguous**

A unique option name did not appear after the option indicator.

An option is specified by a forward slash (/) and a name. The name can be specified by an abbreviation of the full name, but the abbreviation must be unambiguous.

For example, since many options begin with the letter **N**, the following command causes this error:

```
LINK /N main;
```

This error can also occur if the wrong version of the linker is being used. Check the directories in the PATH environment variable for other versions of LINK.EXE.

**L1003**     **/Q and /EXEPACK incompatible**

LINK cannot be given both the /Q option and the /EXEPACK option.

**L1004**     *value* : **invalid numeric value**

An incorrect value was specified with a LINK option.

For example, this error occurs if a nonnumeric string is specified with an option that requires a number.

**L1005**     *option* : **packing limit exceeds 64K**

The value specified with the /PACKC or /PACKD option exceeded the limit of 65,536 bytes.

**L1006**     *number* : **stack size exceeds 64K-2**

One of the following may have occurred:

- ◆ The given value specified with the /STACK option exceeded the limit of 65,534 bytes.
- ◆ A space appeared before or after the colon (: ) between /STACK and the argument specified with it.

**L1007**     **/OVERLAYINTERRUPT : interrupt number exceeds 255**

An overlay interrupt number greater than 255 was specified with the /OV option value.

Check the *Microsoft MS-DOS Programmer's Reference* or other MS-DOS technical manual for information about interrupts.

**L1008**     **/SEGMENTS : segment limit set too high**

The value specified with the /SEG option exceeded 16,375.

**L1009**     *value* : **/CPARM : illegal value**

The value specified with the /CPARM option was not in the range 1-65,535.

- L1020 no object files specified**  
The object-files field was empty.  
LINK requires the name of at least one object file.
- L1021 cannot nest response files**  
A response file was specified in a response file.
- L1022 response line too long**  
A line in a response file was longer than 255 characters.  
To extend a field to another line, put a plus sign (+) at the end of the current line.
- L1023 terminated by user**  
The LINK session was halted by CTRL+C or CTRL+BREAK.
- L1024 nested right parentheses**  
The parentheses for assigning overlays were specified incorrectly.
- L1025 nested left parentheses**  
The parentheses for assigning overlays were specified incorrectly.
- L1026 unmatched right parenthesis**  
The parentheses for assigning overlays were specified incorrectly.
- L1027 unmatched left parenthesis**  
The parentheses for assigning overlays were specified incorrectly.
- L1030 missing internal name**  
An **IMPORTS** statement specified an ordinal value but not an internal name for the routine or data item being imported.  
An item imported by ordinal must be given an internal name.
- L1031 module description redefined**  
The module-definition (.DEF) file contained more than one **DESCRIPTION** statement.
- L1032 module name redefined**  
The module-definition (.DEF) file contained more than one **NAME** or **LIBRARY** statement.
- L1033 input line too long; *number* characters allowed**  
The LINK command line cannot exceed the given number of characters.

- L1034 name truncated to *string***  
A name specified either on the LINK command line or in a module-definition (.DEF) file exceeded 255 characters. The name was truncated to the given string.  
This is a warning, not a fatal error. However, it indicates a serious problem. This message may be followed by another error as LINK tries to use the specified name. For example, if the string is a filename, LINK issues an error when it cannot open the file.
- L1035 syntax error in module-definition file**  
A statement in the module-definition (.DEF) file was incorrect.
- L1040 too many exported entries**  
The program exceeded the limit of 65,535 exported names.
- L1041 resident names table overflow**  
The size of the resident names table exceeded 65,535 bytes.  
An entry in the resident names table is made for each exported routine designated **RESIDENTNAME** and consists of the name plus three bytes of information. The first entry is the module name.  
Reduce the number of exported routines or change some to nonresident status.
- L1042 nonresident names table overflow**  
The size of the nonresident names table exceeded 65,535 bytes.  
An entry in the nonresident names table is made for each exported routine not designated **RESIDENTNAME** and consists of the name plus three bytes of information. The first entry is the **DESCRIPTION** statement.  
Reduce the number of exported routines or change some to resident status.
- L1043 relocation table overflow**  
More than 32,768 long calls, long jumps, or other long pointers appeared in the program.  
Replace long references with short references wherever possible.
- L1044 imported names table overflow**  
The size of the imported names table exceeds 65,535 bytes.  
An entry in the imported names table is made for each new name given in the **IMPORTS** section, including the module names, and consists of the name plus one byte.  
Reduce the number of imports.

- L1045 too many TYPDEF records**  
An object file contained more than 255 TYPDEF records.  
TYPDEF records describe communal variables. (TYPDEF is an MS-DOS term. It is explained in the *Microsoft MS-DOS Programmer's Reference* and in other reference books on MS-DOS.)  
This error appears only with programs created by the Microsoft FORTRAN Compiler or other compilers that support communal variables.
- L1046 too many external symbols in one module**  
An object file specified more than 1023 external symbols.  
Break the object file into smaller files.
- L1047 too many group, segment, and class names in one module**  
An object file contained too many group, segment, and class names.  
Reduce the number of groups, segments, or classes in the object file, or break the object file into smaller files.
- L1048 too many segments in one module**  
An object file had more than 255 segments.  
Either create fewer segments or break the object file into smaller files.
- L1049 too many segments**  
The program contained more than the maximum number of segments.  
The maximum number of segments is set with the /SEG option (in the range 1–16,384). If /SEG is not specified, the default is 128.  
If this error occurs when linking a p-code program, recompile and use CL's /NQ option to combine the temporary p-code segments.
- L1050 too many groups in one module**  
An object file contained more than 21 group definitions (GRPDEF).  
Reduce the number of group definitions or split the module.  
(Group definitions are explained in the *Microsoft MS-DOS Programmer's Reference* and in other reference books on MS-DOS.)
- L1051 too many groups**  
The program defined more than 20 groups, not counting DGROUP.  
Reduce the number of groups.
- L1052 too many libraries**  
An attempt was made to link with more than 32 libraries.  
Combine libraries, or use modules that require fewer libraries.

**L1053 out of memory for symbol table**

The program had more symbolic information than could fit in available memory. Symbolic information includes public, external, segment, group, class, and file names.

One of the following may be a solution:

- ◆ Eliminate as many public symbols as possible.
- ◆ Combine object files or segments.
- ◆ Link from the command line instead of from a makefile or PWB.
- ◆ Remove terminate-and-stay-resident programs or otherwise free some memory.

**L1054 requested segment limit too high**

LINK did not have enough memory to allocate tables describing the requested number of segments. The number of segments is the value specified with the /SEG option or the default of 128.

One of the following may be a solution:

- ◆ Assemble with /c and link in a separate step.
- ◆ Link again using the /SEG option to set fewer segments.
- ◆ Remove terminate-and-stay-resident programs or otherwise free some memory.

**L1056 too many overlays**

The program defined more than 127 overlays.

**L1057 data record too large**

An LEDATA record in an object module contained more than 1024 bytes of data. This is a translator error. (LEDATA is an MS-DOS term explained in the *Microsoft MS-DOS Programmer's Reference* and in other MS-DOS reference books.)

Note which translator (compiler or assembler) produced the incorrect object module. Please report the circumstances of the error to Microsoft Corporation by following the instructions in the "Microsoft Support Services" section of the introduction to this book.

**L1063 out of memory for debugging information**

LINK ran out of memory for processing debugging information.

Reduce the amount of debugging information by compiling some object files with /Zd instead of /Zi or with neither option.

- L1064 out of memory—near/far heap exhausted**  
LINK was not able to allocate enough memory for the given heap.  
One of the following may be a solution:
- ◆ Reduce the size of code, data, and symbols in the program.
  - ◆ If the program is a segmented executable file, put some code into a dynamic-link library.
- L1065 too many interoverlay calls**  
**use /DYNAMIC:*nnn*; current limit is *number***  
The program had more than the given limit of interoverlay calls.  
The maximum number of interoverlay calls is set with the /DYNAMIC option (in the range 1–10,922). If /DYNAMIC is not specified, the default is 256.  
To determine the setting needed by the program, run LINK with the /INFO option. The output gives the number of interoverlay calls that are generated and the current limit.
- L1066 size of *overlaynumber* overlay exceeds 64K**  
The overlay represented by the given number exceeded the MOVE size limit of 65,535 bytes.
- L1067 memory allocation error**  
Note the circumstances of the error and notify Microsoft Corporation by following the instructions in the “Microsoft Support Services” section of the introduction to this book.
- L1070 *segment* : segment size exceeds 64K**  
A single segment contained more than 65,536 bytes of code or data.  
Try changing the memory model to use far code or data as appropriate. If the program is in C, use CL’s /NT option or the **\_\_based** keyword (or its predecessor, the **alloc\_text** pragma) to build smaller segments.
- L1071 segment **\_TEXT** exceeds 64K–16**  
The segment named **\_TEXT** grew larger than 65,520 bytes. This error is likely to occur only in small-model C programs, but it can occur when any program with a segment named **\_TEXT** is linked using the LINK /DOSSEG option.  
Small-model C programs must reserve code addresses 0 and 1; this range is increased to 16 for alignment purposes.  
Try compiling and linking using the medium or large model. If the program is in C, use CL’s /NT option or the **\_\_based** keyword (or its predecessor, the **alloc\_text** pragma) to build smaller segments.
- L1072 common area exceeds 64K**  
The program had more than 65,536 bytes of communal variables. This error occurs only with programs produced by the Microsoft FORTRAN optimizing compiler or other compilers that support communal variables.

- L1073 file-segment limit exceeded**  
The number of physical or file segments exceeded the limit of 255 imposed by the Windows operating system for each application or dynamic-link library.  
A file segment is created for each group definition, nonpacked logical segment, and set of packed segments.  
Reduce the number of segments, or put more information into each segment. Use the /PACKC option or the /PACKD option or both.
- L1074 *group* : group exceeds 64K**  
The given group exceeds the limit of 65,536 bytes.  
Reduce the size of the group, or remove any unneeded segments from the group. Refer to the map file for a listing of segments.
- L1075 entry table exceeds 64K-1**  
The entry table exceeded the limit of 65,535 bytes.  
The table contains an entry for each exported routine and for each address that is the target of a far relocation, when **PROTMODE** is not enabled and the target segment is designated **MOVABLE**.  
Declare **PROTMODE** if applicable, reduce the number of exported routines, or make some segments **FIXED** if possible.
- L1078 file-segment alignment too small**  
The segment-alignment size specified with the /ALIGN option was too small.
- L1080 cannot open list file**  
The disk or the root directory was full.  
Delete or move files to make space.
- L1081 out of space for run file**  
The disk or the root directory was full.  
Delete or move files to make space.
- L1082 *filename* : stub file not found**  
LINK could not open the file given in the **STUB** statement in the module-definition (.DEF) file.  
The file must be in the current directory or in a directory specified by the PATH environment variable.

**L1083 cannot open run file**

One of the following may have occurred:

- ◆ The disk or the root directory was full.
- ◆ Another process opened or deleted the file.
- ◆ A read-only file existed with the same name.
- ◆ The floppy disk containing the file was removed.
- ◆ A hard-disk error occurred.

**L1084 cannot create temporary file**

One of the following may have occurred:

- ◆ The disk or the root directory was full.
- ◆ The directory specified in the TMP environment variable did not exist.

**L1085 cannot open temporary file—*message***

LINK could not open a temporary file for the given reason.

One of the following may have occurred:

- ◆ The disk or the root directory was full.
- ◆ The directory specified in the TMP environment variable did not exist.

**L1086 temporary file missing**

An internal error has occurred.

Note the circumstances of the error and notify Microsoft Corporation by following the instructions in the “Microsoft Support Services” section of the introduction to this book.

**L1087 unexpected end-of-file on temporary file**

A problem occurred with the temporary linker-output file.

One of the following may have occurred:

- ◆ The disk that holds the temporary file was removed.
- ◆ The disk or directory specified in the TMP environment variable was full.

**L1088 out of space for list file**

The disk or the root directory was full.

Delete or move files to make space.



- L1089**     *filename* : **cannot open response file**  
LINK could not find the given response file.  
One of the following may have occurred:
- ◆ The response file does not exist.
  - ◆ The name of the response file was incorrectly specified.
  - ◆ An old version of LINK was used. Check your path. To see the version number of LINK, run LINK with the */?* option.
- L1090**     **cannot reopen list file**  
The original floppy disk was not replaced at the prompt.  
Restart the LINK session.
- L1091**     **unexpected end-of-file on library**  
The floppy disk containing the library was probably removed.  
Replace the disk containing the library and run LINK again.
- L1092**     **cannot open module-definition file**  
LINK could not find the specified module-definition (.DEF) file.  
Check that the name of the .DEF file is spelled correctly.
- L1093**     *filename* : **object file not found**  
LINK could not find the given object file.  
Check that the name of the object file is spelled correctly.
- L1094**     *filename* : **cannot open file for writing**  
LINK was unable to open the given file with write permission.  
Check the attributes for the file.
- L1095**     *filename* : **out of space for file**  
LINK ran out of disk space for the specified output file.  
Delete or move files to make space.
- L1096**     **unexpected end-of-file in response file**  
LINK encountered a problem while reading the response file.  
One of the following may be a cause:
- ◆ The response file is corrupt.
  - ◆ The file was deleted between reads.

- L1097**     **I/O error—*message***  
LINK encountered the given input or output error.
- L1098**     **cannot open include file *filename*—*message***  
LINK could not open the given include file for the given reason.  
An include file is specified in an **INCLUDE** statement in the module-definition (.DEF) file.
- L1100**     **stub .EXE file invalid**  
The file specified in the **STUB** statement in the module-definition (.DEF) file is not a valid MS-DOS executable file.
- L1101**     **invalid object module**  
LINK could not link one of the object files.  
Check that the correct version of LINK is being used.  
If the error persists after recompiling, note the circumstances of the error and notify Microsoft Corporation by following the instructions in the “Microsoft Support Services” section of the introduction to this book.
- L1102**     **unexpected end-of-file**  
The given library or object file had an invalid format.
- L1103**     **attempt to access data outside segment bounds**  
A data record in an object file specified data extending beyond the end of a segment. This is a translator error.  
Note which translator (compiler or assembler) produced the incorrect object module and the circumstances in which it was produced. Please report the error to Microsoft Corporation by following the instructions in the “Microsoft Support Services” section of the introduction to this book.
- L1104**     ***filename* : invalid library**  
The given file had an invalid format for a library.
- L1105**     **invalid object due to interrupted incremental compile**  
Delete the object file, recompile the program, and relink.
- L1106**     **unknown COMDAT allocation type for *symbol*; record ignored**  
This is a translator error. The given symbol is either a routine or a data item.  
Note which translator (compiler or assembler) produced the incorrect object module and the circumstances in which it was produced. Please report this error to Microsoft Corporation by following the instructions in the “Microsoft Support Services” section of the introduction to this book.

- L1107 unknown COMDAT selection type for *symbol*; record ignored**  
This is a translator error. The given symbol is either a routine or a data item.  
Note which translator (compiler or assembler) produced the incorrect object module and the circumstances in which it was produced. Please report this error to Microsoft Corporation by following the instructions in the “Microsoft Support Services” section of the introduction to this book.
- L1108 invalid format of debugging information**  
This is a translator error.  
Note which translator (compiler or assembler) produced the incorrect object module and the circumstances in which it was produced. Please report this error to Microsoft Corporation by following the instructions in the “Microsoft Support Services” section of the introduction to this book.
- L1113 unresolved COMDEF; internal error**  
This is a translator error.  
Note which translator (compiler or assembler) produced the incorrect object module and the circumstances in which it was produced. Please report this error to Microsoft Corporation by following the instructions in the “Microsoft Support Services” section of the introduction to this book.
- L1114 unresolved COMDAT *symbol*; internal error**  
This is a translator error. The given symbol is either a routine or a data item.  
Note which translator (compiler or assembler) produced the incorrect object module and the circumstances in which it was produced. Please report this error to Microsoft Corporation by following the instructions in the “Microsoft Support Services” section of the introduction to this book.
- L1115 *option* : option incompatible with overlays**  
The given option cannot be used when linking an overlaid program.
- L1117 unallocated COMDAT *symbol*; internal error**  
This is a translator error. The given symbol is either a routine or a data item.  
Note which translator (compiler or assembler) produced the incorrect object module and the circumstances in which it was produced. Please report this error to Microsoft Corporation by following the instructions in the “Microsoft Support Services” section of the introduction to this book.
- L1123 *segment* : segment defined both 16-bit and 32-bit**  
Define the segment as either 16-bit or 32-bit.

**L1127 far segment references not allowed with /TINY**

The /TINY option for producing a .COM file was used in a program that has a far segment reference.

Far segment references are not compatible with the .COM file format. High-level-language programs cause this error unless the language supports the tiny memory model. An assembly-language program that references a segment address also causes this error.

For example, the following causes this error:

```
mov ax, seg mydata
```

**L1128 too many nested include files in module-definition file**

Nesting of **INCLUDE** statements in a module-definition (.DEF) file is limited to 10 levels.

**L1129 missing or invalid include file name**

The file specification in an **INCLUDE** statement in the module-definition (.DEF) file was missing or was not a valid filename.

## LINK Error Messages

**L2000 imported starting address**

The program starting address as specified in the **END** statement in an assembly-language file is an imported routine. This is not supported by the Windows operating system.

**L2002 fixup overflow at *number* in segment *segment***

This error message is followed by one of these strings:

- ◆ target external *symbol*
- ◆ **frm seg *name1*, tgt seg *name2*, tgt offset *number***

A fixup overflow is an attempted reference to code or data that is impossible because the source location (where the reference is made “from”) and the target address (where the reference is made “to”) are too far apart. Usually the problem is corrected by examining the source location.

For information about frame and target segments, see the *Microsoft MS-DOS Programmer's Reference*.

**L2003 near reference to far target at *offset* in segment *segment***

**pos: *offset* target external *name***

The program issued a near call or jump to a label in a different segment.

This error occurs most often when specifically declaring an external procedure as near that should be declared as far.

This error can be caused by compiling a small-model C program with CL's /NT option.

- L2005**     **fixup type unsupported at *number* in segment *segment***  
A fixup type occurred that is not supported by LINK. This is probably a translator error.  
Note which translator (compiler or assembler) produced the incorrect object module and the circumstances in which it was produced. Please report this error to Microsoft Corporation by following the instructions in the “Microsoft Support Services” section of the introduction to this book.
- L2010**     **too many fixups in LIDATA record**  
The number of far relocations (pointer- or base-type) in an LIDATA record exceeds the limit imposed by LINK.  
The cause is usually a **DUP** statement in an assembly-language program. The limit is dynamic: a 1,024-byte buffer is shared by relocations and the contents of the LIDATA record. There are 8 bytes per relocation.  
Reduce the number of far relocations in the **DUP** statement.
- L2011**     *identifier* : **NEAR/HUGE conflict**  
Conflicting **NEAR** and **HUGE** attributes were given for a communal variable. This error can occur only with programs produced by the Microsoft FORTRAN optimizing compiler or other compilers that support communal variables.
- L2012**     *arrayname* : **array-element size mismatch**  
A far communal array was declared with two or more different array-element sizes (for instance, an array was declared once as an array of characters and once as an array of real numbers). This error occurs only with the Microsoft FORTRAN optimizing compiler and any other compiler that supports far communal arrays.
- L2013**     **LIDATA record too large**  
An LIDATA record contained more than 512 bytes. This is probably a translator error.  
Note which translator (compiler or assembler) produced the incorrect object module and the circumstances in which it was produced. Please report this error to Microsoft Corporation by following the instructions in the “Microsoft Support Services” section of the introduction to this book.
- L2022**     *entry (alias internalname)* : **export undefined**  
The internal name of the given exported routine or data item is undefined.
- L2023**     *entry (alias internalname)* : **export imported**  
The internal name of the given exported routine or data item conflicts with the internal name of a previously imported routine or data item.

**L2024**     *symbol* : **special symbol already defined**

The program defined a symbol name already used by LINK for one of its own low-level symbols. For example, LINK generates special symbols used in overlay support and other operations.

Choose another name for the symbol to avoid conflict.

**L2025**     *symbol* : **symbol defined more than once**

The same symbol has been found in two different object files.

**L2026**     **entry ordinal** *number*, *name name* : **multiple definitions for same ordinal**

The given exported name with the given ordinal number conflicted with a different exported name previously assigned to the same ordinal. Only one name can be associated with a particular ordinal.

**L2027**     *name* : **ordinal too large for export**

The given exported name was assigned an ordinal that exceeded the limit of 65,535 (64K-1).

**L2028**     **automatic data segment plus heap exceed 64K**

The size of the sum of the following exceeds 64K:

- ◆ Data declared in DGROUP
- ◆ The size of the heap specified in the **HEAPSIZE** statement in the module-definition (.DEF) file
- ◆ The size of the stack specified in either the **/STACK** option or the **STACKSIZE** statement in the .DEF file

Reduce near-data allocation, **HEAPSIZE**, or stack.

**L2029**     *symbol* : **unresolved external**

A symbol was declared to be external in one or more modules, but it was not publicly defined in any module or library.

The name of the unresolved external symbol is given, followed by a list of object modules that contain references to this symbol. This message and the list of object modules are written to the map file, if one exists.

One cause of this error is using the **/NOI** option for files that use case inconsistently in identifiers.

This error can also occur when a program compiled with C/C++ version 7.0 (or later) is linked using **/NOD**. The **/NOD** option tells LINK to ignore all default libraries named in object files. C/C++ 7.0 embeds in an object file both the name of the default run-time library and OLDNAMES.LIB. To avoid this error, either specify OLDNAMES.LIB in the *libraries* field or specify **/NOD:library** where *library* is the name of the default run-time library to be excluded from the search.

- L2030 starting address not code (use class 'CODE')**  
The program starting address, as specified in the **END** statement of an .ASM file, should be in a code segment. Code segments are recognized if their class name ends in “CODE”. This is an error in a segmented-executable file.  
The error message can be disabled by including the **REALMODE** statement in the module-definition (.DEF) file.
- L2041 stack plus data exceed 64K**  
If the total of near data and requested stack size exceeds 64K, the program will not run correctly. LINK checks for this condition only when /DOSSEG is enabled, which is the case in the library startup module for Microsoft language libraries.  
For object modules compiled with the Microsoft C or FORTRAN optimizing compilers, recompile with the /Gt command-line option to set the data-size threshold to a smaller number.  
This is a fatal LINK error.
- L2043 Quick library support module missing**  
The required file QUICKLIB.OBJ was missing. QUICKLIB.OBJ must be linked in when creating a Quick library.
- L2044 *symbol* : symbol multiply defined, use /NOE**  
LINK found what it interprets as a public-symbol redefinition, probably because a symbol defined in a library was redefined.  
Relink with the /NOE option. If error L2025 results for the same symbol, then this is a genuine symbol-redefinition error.
- L2046 share attribute conflict—segment *segment* in group *group***  
The given segment has a different sharing attribute than other segments that are assigned to the given group.  
All segments assigned to a group must have the same attribute, either **SHARED** or **NONSHARED**. The attributes cannot be mixed.
- L2047 IOPL attribute conflict—segment *segment* in group *group***  
The specified segment is a member of the specified group but has an **IOPL** attribute that is different from other segments in the group.

**L2048 Microsoft Overlay Manager module not found**

Overlays were designated, but an overlay manager was missing.

By default, the overlay manager is the Microsoft Overlay Virtual Environment (MOVE). This is provided in MOVE.LIB, which is a component library of the default combined libraries provided with Microsoft C/C++ version 7.0. The error occurs when LINK cannot find the `_moveinit` routine.

If the `/OLDOVERLAY` option is specified, the overlay manager is the Microsoft Static Overlay Manager, which is also provided in the default combined libraries.

**L2050 USE16/USE32 attribute conflict—segment *segment* in group *group***

You cannot group 16-bit segments with 32-bit segments.

**L2052 *symbol* : unresolved external; possible calling convention mismatch**

A symbol was declared to be external in one or more modules, but LINK could not find it publicly defined in any module or library.

The name of the unresolved external symbol is given, followed by a list of object modules that contain references to this symbol. The error message and the list of object modules are written to the map file, if one exists.

This error occurs in a C-language program when a prototype for an externally defined function is omitted and the program is compiled with CL's `/Gr` option. The calling convention for `__fastcall` does not match the assumptions that are made when a prototype is not included for an external function.

Either include a prototype for the function, or compile without the `/Gr` option.

**L2057 duplicate of *function* with different size found; record ignored**

An inconsistent class definition was found.

Check the include files and recompile.

**L2058 different duplicate of *function* found; record ignored**

An inconsistent class definition was found.

Check the include files and recompile.

**L2060 size of data block associated with *symbol* (16-bit segment) exceeds 64K**

A class had too many virtual functions. The given symbol is the v-table for the class, in the form of a decorated name.

**L2061 no space for data block associated with *function* inside *segment* *segment***

The given function was allocated to the given segment, but the segment was full.



- L2062 continuation of COMDAT *function* has conflicting attributes; record ignored**  
This is a translator error.  
Note which translator (compiler or assembler) produced the incorrect object module and the circumstances in which it was produced. Please report this error to Microsoft Corporation by following the instructions in the “Microsoft Support Services” section of the introduction to this book.
- L2063 *function* is allocated in undefined segment**  
The given function was allocated to a nonexistent segment.
- L2064 starting address not in the root overlay**  
The segment or object file that contains the starting address for the program was placed into an overlay.  
The starting address in a C-language program is provided by the **main** function.

## LINK Warning Messages

- L4000 segment displacement included near *offset in segment segment***  
This is the warning generated by the `/W` option.
- L4001 frame-relative fixup, frame ignored near *offset in segment segment***  
A reference was made relative to a segment or group that is different from the target segment of the reference.  
For example, if `_id1` is defined in segment `_TEXT`, the instruction call `DGROUP:_id1` produces this warning. The frame `DGROUP` is ignored, so LINK treats the call as if it were call `_TEXT:_id1`.
- L4002 frame-relative absolute fixup near *offset in segment segment***  
A reference was made relative to a segment or group that was different from the target segment of the reference, and both segments are absolute (defined with `AT`).  
LINK assumed that the executable file will be run only with MS-DOS.
- L4004 possible fixup overflow at *offset in segment segment***  
A near call or jump was made to another segment that was not a member of the same group as the segment from which the call or jump was made.  
This can cause an incorrect real-mode address calculation when the distance between the paragraph address (frame number) of the segment group and the target segment is greater than 64K, even though the distance between the segment where the call or jump was actually made and the target segment is less than 64K.
- L4010 invalid alignment specification**  
The number specified in the `/ALIGN` option must be a power of 2 in the range 2–32,768.

**L4011**     **/PACKC value exceeding 64K–36 unreliable**

The packing limit specified with the /PACKC option was in the range 65,501–65,536 bytes. Code segments with a size in this range are unreliable on some versions of the 80286 processor.

**L4012**     **/HIGH disables /EXEPACK**

The /HIGH and /EXEPACK options cannot be used at the same time.

**L4013**     ***option* : option ignored for segmented executable file**

The given option is not allowed for segmented-executable programs.

**L4014**     ***option* : option ignored for DOS executable file**

The given option is not allowed for MS-DOS programs.

**L4015**     **/CO disables /DSALLOC**

The /CO and /DSALLOC options cannot be used at the same time.

**L4016**     **/CO disables /EXEPACK**

The /CO and /EXEPACK options cannot be used at the same time.

**L4017**     ***option* : unrecognized option name; option ignored**

The given option was not a valid LINK option. LINK ignored the option specification.

One of the following may be a cause:

- ◆ An obsolete option was specified to the current version of LINK. For example, the /INCR option is obsolete in LINK version 5.30. The current options are described in the manual and in online Help. To see a list of options, run LINK with the /? option.
- ◆ An old version of LINK was used. Check your path. To see the version number of LINK, run LINK with the /? option.
- ◆ The name was incorrectly specified. For example, the option specification /NODEFAULTLIBSEARCH is an invalid abbreviation of the /NODEFAULTLIBRARYSEARCH option. Option names can be shortened by removing letters only from the end of the name.

**L4018**     **missing or unrecognized application type; option *option* ignored**

The /PM option accepts only the keywords **PM**, **VIO**, and **NOVIO**.

**L4020**     ***segment* : code-segment size exceeds 64K–36**

Code segments that are 65,501 through 65,536 bytes in length may be unreliable on some versions of the 80286 processor.

- L4021 no stack segment**  
The program did not contain a stack segment defined with the STACK combine type.  
Normally, every program should have a stack segment with the combine type specified as STACK. You can ignore this message if you have a specific reason for not defining a stack or for defining one without the STACK combine type. Linking with versions of LINK earlier than version 2.40 might cause this message since these linkers search libraries only once.
- L4022 *group1, group2* : groups overlap**  
The given groups overlap. Since a group is assigned to a physical segment, groups cannot overlap in segmented-executable files.  
Reorganize segments and group definitions so the groups do not overlap. Refer to the map file.
- L4023 *entry(internalname)* : export internal name conflict**  
The internal name of the given exported function or data item conflicted with the internal name of a previous import definition or export definition.
- L4024 *name* : multiple definitions for export name**  
The given name was exported more than once, an action that is not allowed.
- L4025 *modulename.entry(internalname)* : import internal name conflict**  
The internal name of the given imported function or data item conflicted with the internal name of a previous export or import. (The given entry is either a name or an ordinal number.)
- L4026 *modulename.entry(internalname)* : self-imported**  
The given function or data item was imported from the module being linked. This error can occur if a module tries to import a function or data item from itself or from another source (such as a DLL) that has the same name.
- L4027 *name* : multiple definitions for import internal name**  
The given internal name was imported more than once. Previous import definitions are ignored.
- L4028 *segment* : segment already defined**  
The given segment was defined more than once in a SEGMENTS statement of the module-definition (.DEF) file.
- L4029 *segment* : DGROUP segment converted to type DATA**  
The given logical segment in the group DGROUP was defined as a code segment.  
DGROUP cannot contain code segments because LINK always considers DGROUP to be a data segment. The name DGROUP is predefined as the automatic (or default) data segment.  
LINK converted the named segment to type DATA.

- L4030**     *segment* : **segment attributes changed to conform with automatic data segment**  
The given logical segment in the group DGROUP was given sharing attributes (**SHARED/NONSHARED**) that differed from the automatic data attributes as declared by the DATA instance specification (**SINGLE/MULTIPLE**). The attributes are converted to conform to those of DGROUP.  
  
The name DGROUP is predefined as the automatic (or default) data segment. DGROUP cannot contain code segments because LINK always considers DGROUP to be a data segment.
- L4031**     *segment* : **segment declared in more than one group**  
A segment was declared to be a member of two different groups.
- L4032**     *segment* : **code-group size exceeds 64K-36**  
The given code group has a size in the range 65,501-65,536 bytes, a size that is unreliable on some versions of the 80286 processor.
- L4033**     **first segment in mixed group *group* is a USE32 segment**  
A 16-bit segment must be first in a group created with both USE16 and USE32 segments. LINK continued to build the executable file, but the resulting file may not run correctly.
- L4034**     **more than 1024 overlay segments; extra put in root**  
The limit on the number of segments that can go into overlays is 1024. Segments starting with the 1025th segment are assigned to the permanently resident portion of the program (the root).
- L4036**     **no automatic data segment**  
The application did not define a group named DGROUP.  
  
DGROUP has special meaning to LINK, which uses it to identify the automatic (or default) data segment used by the operating system. Most segmented-executable applications require DGROUP.  
  
This warning will not be issued if **DATA NONE** is declared or if the executable file is a dynamic-link library.
- L4037**     *group* : **both USE16 and USE32 segments in group; assuming USE32**  
The given group was allocated contributions from both 16-bit segments and 32-bit segments.

- L4038 program has no starting address**  
The segmented-executable application had no starting address. A missing starting address will usually cause the program to fail.  
High-level languages automatically specify a starting address. In a C-language program, this is provided by the **main** function.  
If you are writing an assembly-language program, specify a starting address with the **END** statement.  
MS-DOS programs and dynamic-link libraries should never receive this message, regardless of whether they have starting addresses.
- L4040 stack size ignored for /TINY**  
LINK ignores stack size if the /TINY option is used and if the stack segment has been defined in front of the code segment.
- L4042 cannot open old version**  
The file specified in the **OLD** statement in the module-definition (.DEF) file could not be opened.
- L4043 old version not segmented executable format**  
The file specified in the **OLD** statement in the module-definition (.DEF) file was not a valid segmented-executable file.
- L4045 name of output file is *filename***  
LINK used the given filename for the output file.  
If the output filename is specified without an extension, LINK assumes the default extension .EXE. Creating a Quick library, DLL, or .COM file forces LINK to use a different extension. In the following cases, if either .EXE or no extension is specified, LINK assumes the appropriate extension:  
/TINY option: .COM  
/Q option: .QLB  
**LIBRARY** statement: .DLL
- L4050 file not suitable for /EXEPACK; relink without**  
The size of the packed load image plus packing overhead was larger than it would be for the unpacked load image. There is no advantage to packing this program.  
Remove /EXEPACK from the LINK command line. In PWB, clear the Pack EXE File check box in the Additional Debug/Release Options dialog box under Link Options.  
This warning also occurs if the name specified in the **LIBRARY** statement in the module-definition (.DEF) file does not match the name specified in the *exefile* field.

- L4051**     *filename* : **cannot find library**  
LINK could not find the given library file.  
One of the following may be a cause:
- ◆ The specified file does not exist. Enter the name or full path specification of a library file.
  - ◆ The LIB environment variable is not set correctly. Check for incorrect directory specifications, mistyping, or a space, semicolon, or hidden character at the end of the line.
  - ◆ An earlier version of LINK is being run. Check the path environment variable and delete or rename earlier linkers.
- L4053**     **VM.TMP : illegal filename; ignored**  
VM.TMP appeared as an object-file name.  
Rename the file and rerun LINK.
- L4054**     *filename* : **cannot find file**  
LINK could not find the specified file.  
Enter a new filename, a new path specification, or both.
- L4055**     **start address not equal to 0x100 for /TINY**  
The starting address for a .COM file must be 100 hexadecimal.  
Put the following line of assembly source code in front of the code segment:  
ORG 100h
- L4056**     **/EXEPACK valid only for OS/2 and real-mode DOS; ignored**  
The /EXEPACK option is incompatible with Windows-based programs.
- L4057**     **stack specified for DLL; ignored**  
A stack was specified for a dynamic-link library (DLL). Either the /STACK option was used on the command line or the **STACKSIZE** statement was used in the module-definition (.DEF) file. LINK ignored the specification and did not create a stack.  
A DLL does not have a stack.
- L4058**     **ignoring alias for already defined symbol** *symbol*  
The specified symbol was redefined in the program. However, it is an identifier from a C runtime library that has an alias to a new name in OLDNAMES.LIB. LINK ignored the alias for the symbol.  
This warning appears only when the /INFO option is specified.
- L4067**     **changing default resolution for weak external** *symbol* **from** *oldresolution* **to** *newresolution*  
LINK found conflicting default resolutions for a weak external. It ignored the first resolution and used the second.

- L4068 ignoring stack size greater than 64K**  
A stack was defined with an invalid size. LINK assumed 64K.
- L4069 filename truncated to *filename***  
A filename specification exceeded the length allowed. LINK assumed the given filename.
- L4070 too many public symbols for sorting**  
LINK uses the stack and all available memory in the near heap to sort public symbols for the /MAP option. This warning is issued if the number of public symbols exceeds the space available for them. In addition, the symbols are not sorted in the map file but are listed in an arbitrary order.
- L4076 no segments defined**  
There was no code in the program.  
This warning can occur if the file contains only resources.
- L4077 symbol *function* not defined; ordered allocation ignored**  
The given function was specified in a **FUNCTIONS** statement in the module-definition (.DEF) file, but the function was not defined.
- L4079 symbol *function* already defined for ordered allocation; duplicate ignored**  
The given function was specified twice in **FUNCTIONS** statements in the module-definition (.DEF) file.
- L4080 changing substitute name for alias *symbol* from *oldalias* to *newalias***  
LINK found conflicting alias names. It ignored the first alias and used the second.
- L4081 cannot execute *program arguments—message***  
LINK could not run the given program (with the given arguments) for the given reason.
- L4082 changing overlay assignment for segment *segment* from *oldnumber* to *newnumber***  
The given segment was assigned to two overlays, represented by *oldnumber* and *newnumber*. LINK assumed the *newnumber* overlay.  
Probably a command-line overlay specification with parentheses conflicted with an overlay specification in the module-definition (.DEF) file.
- L4083 changing overlay assignment for symbol *symbol* from *oldnumber* to *newnumber***  
The given symbol was assigned to two overlays, represented by *oldnumber* and *newnumber*. LINK assumed the *newnumber* overlay.  
Probably a command-line overlay specification with parentheses conflicted with an overlay specification in the module-definition (.DEF) file.

**L4084**     *option : argument missing; option ignored*

The given option requires an argument, but none was specified.

For example, the following option specification causes this error:

```
/ONERROR
```

**L4085**     *option : argument invalid; assuming argument*

The given option was specified with a numeric argument that was out of range for the option. LINK assumed the given argument.

For example, the option specification /DYNAMIC:11000 causes the following error:

```
/DYNAMIC:11000 : argument invalid; assuming 10922
```

**L4086**     */r not first on command line; ignored*

This message appears if the /r option is not specified before other LINK options. /r must be the first option specified or it will be ignored.

## ML Error Messages

### ML Fatal Errors

**A1000**     *cannot open file: filename*

The assembler was unable to open a source, include, or output file.

One of the following may be a cause:

- ◆ The file does not exist.
- ◆ The file is in use by another process.
- ◆ The filename is not valid.
- ◆ A read-only file with the output filename already exists.
- ◆ Not enough file handles exist. In MS-DOS, increase the number of file handles by changing the FILES setting in CONFIG.SYS to allow a larger number of open files. FILES=50 is the recommended setting.
- ◆ The current drive is full.
- ◆ The current directory is the root and is full.
- ◆ The device cannot be written to.
- ◆ The drive is not ready.



**A1001 I/O error closing file**

The operating system returned an error when the assembler attempted to close a file.

This error can be caused by having a corrupt file system or by removing a disk before the file could be closed.

**A1002 I/O error writing file**

The assembler was unable to write to an output file.

One of the following may be a cause:

- ◆ The current drive is full.
- ◆ The current directory is the root and is full.
- ◆ The device cannot be written to.
- ◆ The drive is not ready.

**A1003 I/O error reading file**

The assembler encountered an error when trying to read a file.

One of the following may be a cause:

- ◆ The disk has a bad sector.
- ◆ The file-access attribute is set to prevent reading.
- ◆ The drive is not ready.

**A1005 assembler limit : macro parameter name table full**

Too many parameters, locals, or macro labels were defined for a macro. There was no more room in the macro name table.

Define shorter or fewer names, or remove unnecessary macros.

**A1006 invalid command-line option: *option***

ML did not recognize the given parameter as an option.

This error is generally caused when there is a syntax error on the command line.

**A1007 nesting level too deep**

The assembler reached its nesting limit. The limit is 20 levels except where noted otherwise.

One of the following was nested too deeply:

- ◆ A high-level directive such as **.IF**, **.REPEAT**, or **.WHILE**
- ◆ A structure definition
- ◆ A conditional-assembly directive
- ◆ A procedure definition
- ◆ A **PUSHCONTEXT** directive (the limit is 10).
- ◆ A segment definition
- ◆ An include file
- ◆ A macro

**A1008 unmatched macro nesting**

Either a macro was not terminated before the end of the file, or the terminating directive **ENDM** was found outside of a macro block.

One cause of this error is omission of the dot before **.REPEAT** or **.WHILE**.

**A1009 line too long**

A line in a source file exceeded the limit of 512 characters.

If multiple physical lines are concatenated with the line-continuation character ( \ ), the resulting logical line is still limited to 512 characters.

**A1010 unmatched block nesting :**

A block beginning did not have a matching end, or a block end did not have a matching beginning. One of the following may be involved:

- ◆ A high-level directive such as **.IF**, **.REPEAT**, or **.WHILE**
- ◆ A conditional-assembly directive such as **IF**, **REPEAT**, or **WHILE**
- ◆ A structure or union definition
- ◆ A procedure definition
- ◆ A segment definition
- ◆ A **POPCONTEXT** directive
- ◆ A conditional-assembly directive, such as an **ELSE**, **ELSEIF**, or **ENDIF** without a matching **IF**

**A1011 directive must be in control block**

The assembler found a high-level directive where one was not expected. One of the following directives was found:

- ◆ **.ELSE** without **.IF**
- ◆ **.ENDIF** without **.IF**
- ◆ **.ENDW** without **.WHILE**
- ◆ **.UNTIL[[CXZ]]** without **.REPEAT**
- ◆ **.CONTINUE** without **.WHILE** or **.REPEAT**
- ◆ **.BREAK** without **.WHILE** or **.REPEAT**
- ◆ **.ELSE** following **.ELSE**

**A1012 error count exceeds 100; stopping assembly**

The number of nonfatal errors exceeded the assembler limit of 100.

Nonfatal errors are in the range A2xxx. When warnings are treated as errors they are included in the count. Warnings are considered errors if you use the /Wx command-line option, or if you set the Warnings Treated as Errors option in the Macro Assembler Global Options dialog box of PWB.

**A1013 invalid numerical command-line argument : *number***

The argument specified with an option was not a number or was an invalid number.

**A1014 too many arguments**

There was insufficient memory to hold all of the command-line arguments.

This error usually occurs while expanding input filename wildcards (\* and ?). To eliminate this error, assemble multiple source files separately.

**A1015 statement too complex**

The assembler ran out of stack space while trying to parse the specified statement.

One or more of the following changes may eliminate this error:

- ◆ Break the statement into several shorter statements.
- ◆ Reorganize the statement to reduce the amount of parenthetical nesting.
- ◆ If the statement is part of a macro, break the macro into several shorter macros.

**A1017 missing source filename**

ML could not find a file to assemble or pass to the linker.

This error is generated when you give ML command-line options without specifying a filename to act upon. To assemble files that do not have a .ASM extension, use the /Ta command-line option.

This error can also be generated by invoking ML with no parameters if the ML environment variable contains command-line options.

**A1901 Internal Assembler Error  
Contact Microsoft Product Support Services**

The MASM driver called ML.EXE, which generated a system error.

Note the circumstances of the error and notify Microsoft Corporation by following the instructions in the “Microsoft Support Services” section of the introduction to this book.

## ML Nonfatal Errors

**A2000 memory operand not allowed in context**

A memory operand was given to an instruction that cannot take a memory operand.

**A2001 immediate operand not allowed**

A constant or memory offset was given to an instruction that cannot take an immediate operand.

**A2002 cannot have more than one ELSE clause per IF block**

The assembler found an **ELSE** directive after an existing **ELSE** directive in a conditional-assembly block (**IF** block).

Only one **ELSE** can be used in an **IF** block. An **IF** block begins with an **IF**, **IFE**, **IFB**, **IFNB**, **IFDEF**, **IFNDEF**, **IFDIF**, or **IFIDN** directive. There can be several **ELSEIF** statements in an **IF** block.

One cause of this error is omission of an **ENDIF** statement from a nested **IF** block.

**A2003 extra characters after statement**

A directive was followed by unexpected characters.

**A2004 symbol type conflict : *identifier***

The **EXTERNDEF** or **LABEL** directive was used on a variable, symbol, data structure, or label that was defined in the same module but with a different type.

**A2005 symbol redefinition : *identifier***

The given nonredefinable symbol was defined in two places.

**A2006**     **undefined symbol :** *identifier*

An attempt was made to use a symbol that was not defined.

One of the following may have occurred:

- ◆ A symbol was not defined.
- ◆ A field was not a member of the specified structure.
- ◆ A symbol was defined in an include file that was not included.
- ◆ An external symbol was used without an **EXTERN** or **EXTERNDEF** directive.
- ◆ A symbol name was misspelled.
- ◆ A local code label was referenced outside of its scope.

**A2007**     **non-benign record redefinition**

A RECORD definition conflicted with a previous definition.

One of the following occurred:

- ◆ There were different numbers of fields.
- ◆ There were different numbers of bits in a field.
- ◆ There was a different label.
- ◆ There were different initializers.

**A2008**     **syntax error :**

A token at the current location caused a syntax error.

One of the following may have occurred:

- ◆ A dot prefix was added to or omitted from a directive.
- ◆ A reserved word (such as **C** or **SIZE**) was used as an identifier.
- ◆ An instruction was used that was not available with the current processor or coprocessor selection.
- ◆ A comparison run-time operator (such as **==**) was used in a conditional assembly statement instead of a relational operator (such as **EQ**).
- ◆ An instruction or directive was given too few operands.
- ◆ An obsolete directive was used.

**A2009**     **syntax error in expression**

An expression on the current line contained a syntax error. This error message may also be a side-effect of a preceding program error.

**A2010**     **invalid type expression**

The operand to **THIS** or **PTR** was not a valid type expression.

**A2011 distance invalid for word size of current segment**

A procedure definition or a code label defined with **LABEL** specified an address size that was incompatible with the current segment size.

One of the following occurred:

- ◆ A **NEAR16** or **FAR16** procedure was defined in a 32-bit segment.
- ◆ A **NEAR32** or **FAR32** procedure was defined in a 16-bit segment.
- ◆ A code label defined with **LABEL** specified **FAR16** or **NEAR16** in a 32-bit segment.
- ◆ A code label defined with **LABEL** specified **FAR32** or **NEAR32** in a 16-bit segment.

**A2012 PROC, MACRO, or macro repeat directive must precede LOCAL**

A **LOCAL** directive must be immediately preceded by a **MACRO**, **PROC**, macro repeat directive (such as **REPEAT**, **WHILE**, or **FOR**), or another **LOCAL** directive.

**A2013 .MODEL must precede this directive**

A simplified segment directive or a **.STARTUP** or **.EXIT** directive was not preceded by a **.MODEL** directive.

A **.MODEL** directive must specify the model defaults before a simplified segment directive, or a **.STARTUP** or **.EXIT** directive may be used.

**A2014 cannot define as public or external : identifier**

Only labels, procedures, and numeric equates can be made public or external using **PUBLIC**, **EXTERN**, or **EXTERNDEF**. Local code labels cannot be made public.

**A2015 segment attributes cannot change : attribute**

A segment was reopened with different attributes than it was opened with originally.

When a **SEGMENT** directive opens a previously defined segment, the newly opened segment inherits the attributes the segment was defined with.

**A2016 expression expected**

The assembler expected an expression at the current location but found one of the following:

- ◆ A unary operator without an operand
- ◆ A binary operator without two operands
- ◆ An empty pair of parentheses, ( ), or brackets, [ ]

**A2017 operator expected**

An expression operator was expected at the current location.

One possible cause of this error is a missing comma between expressions in an expression list.

- A2018**     **invalid use of external symbol : *identifier***  
An attempt was made to compare the given external symbol using a relational operator. The comparison cannot be made because the value or address of an external symbol is not known at assembly time.
- A2019**     **operand must be RECORD type or field**  
The operand following the **WIDTH** or **MASK** operator was not valid.  
The **WIDTH** operator takes an operand that is the name of a field or a record. The **MASK** operator takes an operand that is the name of a field or a record type.
- A2020**     **identifier not a record : *identifier***  
A record type was expected at the current location.
- A2021**     **record constants cannot span line breaks**  
A record constant must be defined on one physical line. A line ended in the middle of the definition of a record constant.
- A2022**     **instruction operands must be the same size**  
The operands to an instruction did not have the same size.
- A2023**     **instruction operand must have size**  
At least one of the operands to an instruction must have a known size.
- A2024**     **invalid operand size for instruction**  
The size of an operand was not valid.
- A2025**     **operands must be in same segment**  
Relocatable operands used with a relational or minus operator were not located in the same segment.
- A2026**     **constant expected**  
The assembler expected a constant expression at the current location. A constant expression is a numeric expression that can be resolved at assembly time.
- A2027**     **operand must be a memory expression**  
The right operand of a **PTR** expression was not a memory expression.  
When the left operand of the **PTR** operator is a structure or union type, the right operand must be a memory expression.

**A2028 expression must be a code address**

An expression evaluating to a code address was expected.

One of the following occurred:

- ◆ **SHORT** was not followed by a code address.
- ◆ **NEAR PTR** or **FAR PTR** was applied to something that was not a code address.

**A2029 multiple base registers not allowed**

An attempt was made to combine two base registers in a memory expression.

For example, the following expressions cause this error:

```
[bx+bp]
[bx][bp]
```

In another example, given the following definition:

```
id1 proc arg1:byte
```

either of the following lines causes this error:

```
mov al, [bx].arg1
lea ax, arg1[bx]
```

**A2030 multiple index registers not allowed**

An attempt was made to combine two index registers in a memory expression.

For example, the following expressions cause this error:

```
[si+di]
[di][si]
```

**A2031 must be index or base register**

An attempt was made to use a register that was not a base or index register in a memory expression.

For example, the following expressions cause this error:

```
[ax]
[bl]
```



**A2032 invalid use of register**

An attempt was made to use a register that was not valid for the intended use.

One of the following occurred:

- ◆ **OFFSET** was applied to a register. (**OFFSET** can be applied to a register under the **M510** option.)
- ◆ A special 386 register was used in an invalid context.
- ◆ A register was cast with **PTR** to a type of invalid size.
- ◆ A register was specified as the right operand of a segment override operator (:).
- ◆ A register was specified as the right operand of a binary minus operator (-).
- ◆ An attempt was made to multiply registers using the \* operator.
- ◆ Brackets ( [ ] ) were missing around a register that was added to something.

**A2033 invalid INVOKE argument : argument *number***

The **INVOKE** directive was passed a special 386 register, or a register pair containing a byte register or special 386 register. These registers are illegal with **INVOKE**.

**A2034 must be in segment block**

One of the following was found outside of a segment block:

- ◆ An instruction
- ◆ A label definition
- ◆ A **THIS** operator
- ◆ A \$ operator
- ◆ A procedure definition
- ◆ An **ALIGN** directive
- ◆ An **ORG** directive

**A2035 DUP too complex**

A declaration using the **DUP** operator resulted in a data structure with an internal representation that was too large.

**A2036 too many initial values for structure: *structure***

The given structure was defined with more initializers than the number of fields in the type declaration of the structure.

- A2037 statement not allowed inside structure definition**  
A structure definition contained an invalid statement.  
A structure cannot contain instructions, labels, procedures, control-flow directives, **.STARTUP**, or **.EXIT**.
- A2038 missing operand for macro operator**  
The assembler found the end of a macro's parameter list immediately after the **!** or **%** operator.
- A2039 line too long**  
A source-file line exceeded the limit of 512 characters.  
If multiple physical lines are concatenated with the line-continuation character (**\**), the resulting logical line is still limited to 512 characters.
- A2040 segment register not allowed in context**  
A segment register was specified for an instruction that cannot take a segment register.
- A2041 string or text literal too long**  
A string or text literal, or a macro function return value, exceeded the limit of 255 characters.
- A2042 statement too complex**  
A statement was too complex for the assembler to parse.  
Reduce either the number of tokens or the number of forward-referenced identifiers.
- A2043 identifier too long**  
An identifier exceeded the limit of 247 characters.
- A2044 invalid character in file**  
The source file contained a character outside a comment, string, or literal that was not recognized as an operator or other legal character.
- A2045 missing angle bracket or brace in literal**  
An unmatched angle bracket (either **<** or **>**) or brace (either **{** or **}**) was found in a literal constant or an initializer.  
One of the following occurred:
- ◆ A pair of angle brackets or braces was not complete.
  - ◆ An angle bracket was intended to be literal, but it was not preceded by an exclamation point (**!**) to indicate a literal character.

- A2046 missing single or double quotation mark in string**  
An unmatched quotation mark (either ' or ") was found in a string.  
One of the following may have occurred:
- ◆ A pair of quotation marks around a string was not complete.
  - ◆ A pair of quotation marks around a string was formed of one single and one double quotation mark.
  - ◆ A single or double quotation mark was intended to be literal, but the surrounding quotation marks were the same kind as the literal one.
- A2047 empty (null) string**  
A string consisted of a delimiting pair of quotation marks and no characters within.  
For a string to be valid, it must contain 1–255 characters.
- A2048 nondigit in number**  
A number contained a character that was not in the set of characters used by the current radix (base).  
This error can occur if a B or D radix specifier is used when the default radix is one that includes that letter as a valid digit.
- A2049 syntax error in floating-point constant**  
A floating-point constant contained an invalid character.
- A2050 real or BCD number not allowed**  
A floating-point (real) number or binary coded decimal (BCD) constant was used other than as a data initializer.  
One of the following occurred:
- ◆ A real number or a BCD was used in an expression.
  - ◆ A real number was used to initialize a directive other than **DWORD**, **QWORD**, or **TBYTE**.
  - ◆ A BCD was used to initialize a directive other than **TBYTE**.
- A2051 text item required**  
A literal constant or text macro was expected.  
One of the following was expected:
- ◆ A literal constant, which is text enclosed in < >
  - ◆ A text macro name
  - ◆ A macro function call
  - ◆ A % followed by a constant expression

- A2052 forced error**  
The conditional-error directive **.ERR** or **.ERR1** was used to generate this error.
- A2053 forced error : value equal to 0**  
The conditional-error directive **.ERRE** was used to generate this error.
- A2054 forced error : value not equal to 0**  
The conditional-error directive **.ERRNZ** was used to generate this error.
- A2055 forced error : symbol not defined**  
The conditional-error directive **.ERRNDEF** was used to generate this error.
- A2056 forced error : symbol defined**  
The conditional-error directive **.ERRDEF** was used to generate this error.
- A2057 forced error : string blank**  
The conditional-error directive **.ERRB** was used to generate this error.
- A2058 forced error : string not blank**  
The conditional-error directive **.ERRNB** was used to generate this error.
- A2059 forced error : strings equal**  
The conditional-error directive **.ERRIDN** or **.ERRIDNI** was used to generate this error.
- A2060 forced error : strings not equal**  
The conditional-error directive **.ERRDIF** or **.ERRDIFI** was used to generate this error.
- A2061 `[[ELSE]]IF2/.ERR2 not allowed : single-pass assembler`**  
A directive for a two-pass assembler was found.  
The Microsoft Macro Assembler (MASM) is a one-pass assembler. MASM does not accept the **IF2**, **ELSEIF2**, and **.ERR2** directives.  
This error also occurs if an **ELSE** directive follows an **IF1** directive.
- A2062 expression too complex for .UNTILCXZ**  
An expression used in the condition that follows **.UNTILCXZ** was too complex.  
The **.UNTILCXZ** directive can take only one expression, which can contain only **==** or **!=**. It cannot take other comparison operators or more complex expressions using operators like **||**.
- A2063 can ALIGN only to power of 2 : *expression***  
The expression specified with the **ALIGN** directive was invalid.  
The **ALIGN** expression must be a power of 2 between 2 and 256, and must be less than or equal to the alignment of the current segment, structure, or union.
- A2064 structure alignment must be 1, 2, or 4**  
The alignment specified in a structure definition was invalid.

- A2065**     **expected : *token***  
The assembler expected the given token.
- A2066**     **incompatible CPU mode and segment size**  
An attempt was made to open a segment with a **USE16**, **USE32**, or **FLAT** attribute that was not compatible with the specified CPU, or to change to a 16-bit CPU while in a 32-bit segment.  
The **USE32** and **FLAT** attributes must be preceded by one of the following processor directives: **.386**, **.386C**, **.386P**, **.486**, or **.486P**.
- A2067**     **LOCK must be followed by a memory operation**  
The **LOCK** prefix preceded an invalid instruction. No instruction can take the **LOCK** prefix unless one of its operands is a memory expression.
- A2068**     **instruction prefix not allowed**  
One of the prefixes **REP**, **REPE**, **REPNE**, or **LOCK** preceded an instruction for which it was not valid.
- A2069**     **no operands allowed for this instruction**  
One or more operands were specified with an instruction that takes no operands.
- A2070**     **invalid instruction operands**  
One or more operands were not valid for the instruction they were specified with.
- A2071**     **initializer too large for specified size**  
An initializer value was too large for the data area it was initializing.
- A2072**     **cannot access symbol in given segment or group: *identifier***  
The given identifier cannot be addressed from the segment or group specified.
- A2073**     **operands have different frames**  
Two operands in an expression were in different frames.  
Subtraction of pointers requires the pointers to be in the same frame. Subtraction of two expressions that have different effective frames is not allowed. An effective frame is calculated from the segment, group, or segment register.
- A2074**     **cannot access label through segment registers**  
An attempt was made to access a label through a segment register that was not assumed to its segment or group.

- A2075 jump destination too far [: by 'n' bytes]**  
The destination specified with a jump instruction was too far from the instruction.  
One of the following may be a solution:
- ◆ Enable the **LJMP** option.
  - ◆ Remove the **SHORT** operator. If **SHORT** has forced a jump that is too far, *n* is the number of bytes out of range.
  - ◆ Rearrange code so that the jump is no longer out of range.
- A2076 jump destination must specify a label**  
A direct jump's destination must be relative to a code label.
- A2077 instruction does not allow NEAR indirect addressing**  
A conditional jump or loop cannot take a memory operand. It must be given a relative address or label.
- A2078 instruction does not allow FAR indirect addressing**  
A conditional jump or loop cannot take a memory operand. It must be given a relative address or label.
- A2079 instruction does not allow FAR direct addressing**  
A conditional jump or loop cannot be to a different segment or group.
- A2080 jump distance not possible in current CPU mode**  
A distance was specified with a jump instruction that was incompatible with the current processor mode.  
For example, 48-bit jumps require **.386** or above.
- A2081 missing operand after unary operator**  
An operator required an operand, but no operand followed.
- A2082 cannot mix 16- and 32-bit registers**  
An address expression contained both 16- and 32-bit registers.  
For example, the following expression causes this error:  
[bx+edi]
- A2083 invalid scale value**  
A register scale was specified that was not 1, 2, 4, or 8.
- A2084 constant value too large**  
A constant was specified that was too big for the context in which it was used.

- A2085 instruction or register not accepted in current CPU mode**  
An attempt was made to use an instruction, register, or keyword that was not valid for the current processor mode.  
For example, 32-bit registers require **.386** or above. Control registers such as CR0 require privileged mode **.386P** or above. This error will also be generated for the **NEAR32**, **FAR32**, and **FLAT** keywords, which require **.386** or above.
- A2086 reserved word expected**  
One or more items in the list specified with a **NOKEYWORD** option were not recognized as reserved words.
- A2087 instruction form requires 80386/486**  
An instruction was used that was not compatible with the current processor mode.  
One of the following processor directives must precede the instruction: **.386**, **.386C**, **.386P**, **.486**, or **.486P**.
- A2088 END directive required at end of file**  
The assembler reached the end of the main source file and did not find an **.END** directive.
- A2089 too many bits in RECORD : *identifier***  
One of the following occurred:
- ◆ Too many bits were defined for the given record field.
  - ◆ Too many total bits were defined for the given record.
- The size limit for a record or a field in a record is 16 bits when doing 16-bit arithmetic or 32 bits when doing 32-bit arithmetic.
- A2090 positive value expected**  
A positive value was not found in one of the following situations:
- ◆ The starting position specified for **SUBSTR** or **@SubStr**
  - ◆ The number of data objects specified for **COMM**
  - ◆ The element size specified for **COMM**
- A2091 index value past end of string**  
An index value exceeded the length of the string it referred to when used with **INSTR**, **SUBSTR**, **@InStr**, or **@SubStr**.
- A2092 count must be positive or zero**  
The operand specified to the **SUBSTR** directive, **@SubStr** macro function, **SHL** operator, **SHR** operator, or **DUP** operator was negative.

**A2093 count value too large**

The length argument specified for **SUBSTR** or **@SubStr** exceeded the length of the specified string.

**A2094 operand must be relocatable**

An operand was not relative to a label.

One of the following occurred:

- ◆ An operand specified with the **END** directive was not relative to a label.
- ◆ An operand to the **SEG** operator was not relative to a label.
- ◆ The right operand to the minus operator was relative to a label, but the left operand was not.
- ◆ The operands to a relational operator were either not both integer constants or not both memory operands. Relational operators can take operands that are both addresses or both non-addresses but not one of each.

**A2095 constant or relocatable label expected**

The operand specified must be a constant expression or a memory offset.

**A2096 segment, group, or segment register expected**

A segment or group was expected but was not found.

One of the following occurred:

- ◆ The left operand specified with the segment override operator (**:**) was not a segment register (**CS**, **DS**, **SS**, **ES**, **FS**, or **GS**), group name, segment name, or segment expression.
- ◆ The **ASSUME** directive was given a segment register without a valid segment address, segment register, group, or the special **FLAT** group.

**A2097 segment expected : *identifier***

The **GROUP** directive was given an identifier that was not a defined segment.

**A2098 invalid operand for OFFSET**

The expression following the **OFFSET** operator must be a memory expression or an immediate expression.

**A2099 invalid use of external absolute**

An attempt was made to subtract a constant defined in another module from an expression.

You can avoid this error by placing constants in include files rather than making them external.

**A2100 segment or group not allowed**

An attempt was made to use a segment or group in a way that was not valid. Segments or groups cannot be added.



- A2101 cannot add two relocatable labels**  
An attempt was made to add two expressions that were both relative to a label.
- A2102 cannot add memory expression and code label**  
An attempt was made to add a code label to a memory expression.
- A2103 segment exceeds 64K limit**  
A 16-bit segment exceeded the size limit of 64K.
- A2104 invalid type for data declaration : *type***  
The given type was not valid for a data declaration.
- A2105 HIGH and LOW require immediate operands**  
The operand specified with either the **HIGH** or the **LOW** operator was not an immediate expression.
- A2107 cannot have implicit far jump or call to near label**  
An attempt was made to make an implicit far jump or call to a near label in another segment.
- A2108 use of register assumed to ERROR**  
An attempt was made to use a register that had been assumed to ERROR with the **ASSUME** directive.
- A2109 only white space or comment can follow backslash**  
A character other than a semicolon (;) or a white-space character (spaces or TAB characters) was found after a line-continuation character (\).
- A2110 COMMENT delimiter expected**  
A delimiter character was not specified for a **COMMENT** directive.  
The delimiter character is specified by the first character that is not white space (spaces or TAB characters) after the **COMMENT** directive. The comment consists of all text following the delimiter until the end of the line containing the next appearance of the delimiter.
- A2111 conflicting parameter definition**  
A procedure defined with the **PROC** directive did not match its prototype as defined with the **PROTO** directive.
- A2112 PROC and prototype calling conventions conflict**  
A procedure was defined in a prototype (using the **PROTO**, **EXTERNDEF**, or **EXTERN** directive), but the calling convention did not match the corresponding **PROC** directive.
- A2113 invalid radix tag**  
The specified radix was not a number in the range 2–16.

- A2114 INVOKE argument type mismatch : argument *number***  
The type of the arguments passed using the **INVOKE** directive did not match the type of the parameters in the prototype of the procedure being invoked.
- A2115 invalid coprocessor register**  
The coprocessor index specified was negative or greater than 7.
- A2116 instructions and initialized data not allowed in AT segments**  
An instruction or initialized data was found in a segment defined with the **AT** attribute.  
Data in **AT** segments must be declared with the **? initializer**.
- A2117 /AT option requires TINY memory model**  
The **/AT** option was specified on the assembler command line, but the program being assembled did not specify the **TINY** memory model with the **.MODEL** directive.  
This error is only generated for modules that specify a start address or use the **.STARTUP** directive.
- A2118 cannot have segment address references with TINY model**  
An attempt was made to reference a segment in a **TINY** model program.  
All **TINY** model code and data must be accessed with **NEAR** addresses.
- A2119 language type must be specified**  
A procedure definition or prototype was not given a language type.  
A language type must be declared in each procedure definition or prototype if a default language type is not specified. A default language type is set using either the **.MODEL** directive, **OPTION LANG**, or the ML command-line options **/Gc** or **/Gd**.
- A2120 PROLOGUE must be macro function**  
The identifier specified with the **OPTION PROLOGUE** directive was not recognized as a defined macro function.  
The user-defined prologue must be a macro function that returns the number of bytes needed for local variables and any extra space needed for the macro function.
- A2121 EPILOGUE must be macro procedure**  
The identifier specified with the **OPTION EPILOGUE** directive was not recognized as a defined macro procedure.  
The user-defined epilogue macro cannot return a value.
- A2122 alternate identifier not allowed with EXTERNDEF**  
An attempt was made to specify an alternate identifier with an **EXTERNDEF** directive.  
You can specify an optional alternate identifier with the **EXTERN** directive but not with **EXTERNDEF**.

- A2123 text macro nesting level too deep**  
A text macro was nested too deeply. The nesting limit for text macros is 40.
- A2125 missing macro argument**  
A required argument to **@InStr**, **@SubStr**, or a user-defined macro was not specified.
- A2126 EXITM used inconsistently**  
The **EXITM** directive was used both with and without a return value in the same macro.  
A macro procedure returns a value; a macro function does not.
- A2127 macro function argument list too long**  
There were too many characters in a macro function's argument list. This error applies also to a prologue macro function called implicitly by the **PROC** directive.
- A2129 VARARG parameter must be last parameter**  
A parameter other than the last one was given the **VARARG** attribute.  
The **:VARARG** specification can be applied only to the last parameter in a parameter list for macro and procedure definitions and prototypes. You cannot use multiple **:VARARG** specifications in a macro.
- A2130 VARARG parameter not allowed with LOCAL**  
An attempt was made to specify **:VARARG** as the type in a procedure's **LOCAL** declaration.
- A2131 VARARG parameter requires C calling convention**  
A **VARARG** parameter was specified in a procedure definition or prototype, but the **C**, **SYSCALL**, or **STDCALL** calling convention was not specified.
- A2132 ORG needs a constant or local offset**  
The expression specified with the **ORG** directive was not valid.  
**ORG** requires an immediate expression with no reference to an external label or to a label outside the current segment.
- A2133 register value overwritten by INVOKE**  
A register was passed as an argument to a procedure, but the code generated by **INVOKE** to pass other arguments destroyed the contents of the register.  
The AX, AL, AH, EAX, DX, DL, DH, and EDX registers may be used by the assembler to perform data conversion.  
Use a different register.
- A2134 structure too large to pass with INVOKE : argument *number***  
An attempt was made with **INVOKE** to pass a structure that exceeded 255 bytes.  
Pass structures by reference if they are larger than 255 bytes.

- A2136 too many arguments to INVOKE**  
The number of arguments passed using the **INVOKE** directive exceeded the number of parameters in the prototype for the procedure being invoked.
- A2137 too few arguments to INVOKE**  
The number of arguments passed using the **INVOKE** directive was fewer than the number of required parameters specified in the prototype for the procedure being invoked.
- A2138 invalid data initializer**  
The initializer list for a data definition was invalid.  
This error can be caused by using the R radix override with too few digits.
- A2140 RET operand too large**  
The operand specified to **RET**, **RETN**, or **RETF** exceeded two bytes.
- A2141 too many operands to instruction**  
Too many operands were specified with a string control instruction.
- A2142 cannot have more than one .ELSE clause per .IF block**  
The assembler found more than one **.ELSE** clause within the current **.IF** block.  
Use **.ELSEIF** for all but the last block.
- A2143 expected data label**  
The **LENGTHOF**, **SIZEOF**, **LENGTH**, or **SIZE** operator was applied to a non-data label, or the **SIZEOF** or **SIZE** operator was applied to a type.
- A2144 cannot nest procedures**  
An attempt was made to nest a procedure containing a parameter, local variable, **USES** clause, or a statement that generated a new segment or group.
- A2145 EXPORT must be FAR : procedure**  
The given procedure was given **EXPORT** visibility and **NEAR** distance.  
All **EXPORT** procedures must be **FAR**. The default visibility may have been set with the **OPTION PROC:EXPORT** statement or the **SMALL** or **COMPACT** memory models.
- A2146 procedure declared with two visibility attributes : procedure**  
The given procedure was given conflicting visibilities.  
A procedure was declared with two different visibilities (**PUBLIC**, **PRIVATE**, or **EXPORT**). The **PROC** and **PROTO** statements for a procedure must have the same visibility.
- A2147 macro label not defined : macrolabel**  
The given macro label was not found.  
A macro label is defined with **:macrolabel**.

- A2148**     **invalid symbol type in expression : *identifier***  
The given identifier was used in an expression in which it was not valid.  
For example, a macro procedure name is not allowed in an expression.
- A2149**     **byte register cannot be first operand**  
A byte register was specified to an instruction that cannot take it as the first operand.
- A2150**     **word register cannot be first operand**  
A word register was specified to an instruction that cannot take it as the first operand.
- A2151**     **special register cannot be first operand**  
A special register was specified to an instruction that cannot take it as the first operand.
- A2152**     **coprocessor register cannot be first operand**  
A coprocessor (stack) register was specified to an instruction that cannot take it as the first operand.
- A2153**     **cannot change size of expression computations**  
An attempt was made to set the expression word size when the size had been already set using the **EXPR16**, **EXPR32**, **SEGMENT:USE32**, or **SEGMENT:FLAT** option or the **.386** or higher processor selection directive.
- A2154**     **syntax error in control-flow directive**  
The condition for a control-flow directive (such as **.IF** or **.WHILE**) contained a syntax error.
- A2155**     **cannot use 16-bit register with a 32-bit address**  
An attempt was made to mix 16-bit and 32-bit offsets in an expression.  
Use a 32-bit register with a symbol defined in a 32-bit segment.  
For example, if `id1` is defined in a 32-bit segment, the following causes this error:  
`id1 [bx]`
- A2156**     **constant value out of range**  
An invalid value was specified for the **PAGE** directive.  
The first parameter of the **PAGE** directive can be either 0 or a value in the range 10–255.  
The second parameter of the **PAGE** directive can be either 0 or a value in the range 60–255.
- A2157**     **missing right parenthesis**  
A right parenthesis, `)`, was missing from a macro function call.  
Be sure that parentheses are in pairs if nested.

**A2158 type is wrong size for register**

An attempt was made to assume a general-purpose register to a type with a different size than the register.

For example, the following pair of statements causes this error:

```
ASSUME bx:far ptr byte ; far pointer is 4 or 6 bytes
ASSUME al:word ; al is a byte reg, cannot hold word
```

**A2159 structure cannot be instanced**

An attempt was made to create an instance of a structure when there were no fields or data defined in the structure definition or when **ORG** was used in the structure definition.

**A2160 non-benign structure redefinition : label incorrect**

A label given in a structure redefinition either did not exist in the original definition or was out of order in the redefinition.

**A2161 non-benign structure redefinition : too few labels**

Not enough members were defined in a structure redefinition.

**A2162 OLDSTRUCT/NOOLDSTRUCT state cannot be changed**

Once the **OLDSTRUCTS** or **NOOLDSTRUCTS** option has been specified and a structure has been defined, the structure scoping cannot be altered or respecified in the same module.

**A2163 non-benign structure redefinition : incorrect initializers**

A **STRUCT** or **UNION** was redefined with a different initializer value.

When structures and unions are defined more than once, the definitions must be identical. This error can be caused by using a variable as an initializer and having the value of the variable change between definitions.

**A2164 non-benign structure redefinition : too few initializers**

A **STRUCT** or **UNION** was redefined with too few initializers.

When structures and unions are defined more than once, the definitions must be identical.

**A2165 non-benign structure redefinition : label has incorrect offset**

The offset of a label in a redefined **STRUCT** or **UNION** differs from the original definition.

When structures and unions are defined more than once, the definitions must be identical. This error can be caused by a missing member or by a member that has a different size than in its original definition.

- A2166 structure field expected**  
The righthand side of a dot operator (.) is not a structure field.  
This error may occur with some code acceptable to previous versions of the assembler. To enable the old behavior, use **OPTION OLDSTRUCTS**, which is automatically enabled by **OPTION M510** or the /Zm command-line option.
- A2167 unexpected literal found in expression**  
A literal was found where an expression was expected.  
One of the following may have occurred:
- ◆ A literal was used as an initializer
  - ◆ A record tag was omitted from a record constant
- A2169 divide by zero in expression**  
An expression contains a divisor whose value is equal to zero.  
Check that the syntax of the expression is correct and that the divisor (whether constant or variable) is correctly initialized.
- A2170 directive must appear inside a macro**  
A **GOTO** or **EXITM** directive was found outside the body of a macro.
- A2171 cannot expand macro function**  
A syntax error prevented the assembler from expanding the macro function.
- A2172 too few bits in RECORD**  
There was an attempt to define a record field of 0 bits.
- A2173 macro function cannot redefine itself**  
There was an attempt to define a macro function inside the body of a macro function with the same name. This error can also occur when a member of a chain of macros attempts to redefine a previous member of the chain.
- A2175 invalid qualified type**  
An identifier was encountered in a qualified type that was not a type, structure, record, union, or prototype.
- A2176 floating point initializer on an integer variable**  
An attempt was made to use a floating-point initializer with **DWORD**, **QWORD**, or **TBYTE**. Only integer initializers are allowed.
- A2177 nested structure improperly initialized**  
The nested structure initialization could not be resolved.  
This error can be caused by using different beginning and ending delimiters in a nested structure initialization.

**A2178 invalid use of FLAT**

There was an ambiguous reference to **FLAT** as a group.

This error is generated when there is a reference to **FLAT** instead of a **FLAT** subgroup. For example,

```
mov    ax, FLAT                ; Generates A2178
mov    ax, SEG FLAT:_data      ; Correct
```

**A2179 structure improperly initialized**

There was an error in a structure initializer.

One of the following occurred:

- ◆ The initializer is not a valid expression.
- ◆ The initializer is an invalid **DUP** statement.

**A2180 improper list initialization**

In a structure, there was an attempt to initialize a list of items with a value or list of values of the wrong size.

**A2181 initializer must be a string or single item**

There was an attempt to initialize a structure element with something other than a single item or string.

This error can be caused by omitting braces ( { } ) around an initializer.

**A2182 initializer must be a single item**

There was an attempt to initialize a structure element with something other than a single item.

This error can be caused by omitting braces ( { } ) around an initializer.

**A2183 initializer must be a single byte**

There was an attempt to initialize a structure element of byte size with something other than a single byte.

**A2184 improper use of list initializer**

The assembler did not expect an opening brace ( { ) at this point.

**A2185 improper literal initialization**

A literal structure initializer was not properly delimited.

This error can be caused by missing angle brackets ( < > ) or braces ( { } ) around an initializer or by extra characters after the end of an initializer.



- A2186 extra characters in literal initialization**  
A literal structure initializer was not properly delimited.  
One of the following may have occurred:
- ◆ There were missing or mismatched angle brackets (< >) or braces ( { } ) around an initializer.
  - ◆ There were extra characters after the end of an initializer.
  - ◆ There was a syntax error in the structure initialization.
- A2187 must use floating point initializer**  
A variable declared with the **REAL4**, **REAL8**, and **REAL10** directives must be initialized with a floating-point number or a question mark (?).  
This error can be caused by giving an initializer in integer form (such as 18) instead of in floating-point form (18.0).
- A2188 cannot use .EXIT for OS\_OS2 with .8086**  
The **INVOKE** generated by the **.EXIT** statement under **OS\_OS2** requires the **.186** (or higher) directive, since it must be able to use the **PUSH** instruction to push immediates directly.
- A2189 invalid combination with segment alignment**  
The alignment specified by the **ALIGN** or **EVEN** directive was greater than the current segment alignment as specified by the **SEGMENT** directive.
- A2190 INVOKE requires prototype for procedure**  
The **INVOKE** directive must be preceded by a **PROTO** statement for the procedure being called.  
When using **INVOKE** with an address rather than an explicit procedure name, you must precede the address with a pointer to the prototype.
- A2191 cannot include structure in self**  
You cannot reference a structure recursively (inside its own definition).
- A2192 symbol language attribute conflict**  
Two declarations for the same symbol have conflicting language attributes (such as **C** and **PASCAL**). The attributes should be identical or compatible.
- A2193 non-benign COMM redefinition**  
A variable was redefined with the **COMM** directive to a different language type, distance, size, or instance count.  
Multiple **COMM** definitions of a variable must be identical.
- A2194 COMM variable exceeds 64K**  
A variable declared with the **COMM** directive in a 16-bit segment was greater than 64K.

- A2195 parameter or local cannot have void type**  
The assembler attempted to create an argument or create a local without a type.  
This error can be caused by declaring or passing a symbol followed by a colon without specifying a type or by using a user-defined type defined as void.
- A2196 cannot use TINY model with OS\_OS2**  
A **.MODEL** statement specified the **TINY** memory model and the **OS\_OS2** operating system. The tiny memory model is not allowed under OS/2.
- A2197 expression size must be 32-bits**  
There was an attempt to use the 16-bit expression evaluator in a 32-bit segment. In a 32-bit segment (**USE32** or **FLAT**), you cannot use the default 16-bit expression evaluator (**OPTION EXPR16**).
- A2198 .EXIT does not work with 32-bit segments**  
The **.EXIT** directive cannot be used in a 32-bit segment; it is valid only when generating 16-bit code.
- A2199 .STARTUP does not work with 32-bit segments**  
The **.STARTUP** directive cannot be used in a 32-bit segment; it is valid only when generating 16-bit code.
- A2200 ORG directive not allowed in unions**  
The **ORG** directive is not valid inside a **UNION** definition.  
You can use the **ORG** directive inside **STRUCT** definitions, but it is meaningless inside a **UNION**.
- A2201 scope state cannot be changed**  
Both **OPTION SCOPED** and **OPTION NOSCOPED** statements occurred in a module.  
You cannot switch scoping behavior in a module.  
This error may be caused by an **OPTION SCOPED** or **OPTION NOSCOPED** statement in an include file.
- A2202 illegal use of segment register**  
You cannot use segment overrides for the FS or GS segment registers when generating floating-point emulation instructions with the **/FPi** command-line option or **OPTION EMULATOR**.
- A2203 cannot declare scoped code label as PUBLIC**  
A code label defined with the "label:" syntax was declared **PUBLIC**. Use the "label:." syntax, the **LABEL** directive, or **OPTION NOSCOPED** to eliminate this error.
- A2204 .MSFLOAT directive is obsolete : ignored**  
The Microsoft Binary Format is no longer supported. You should convert your code to the IEEE numeric standard, which is used in the 80x87-series coprocessors.

**A2205 ESC instruction is obsolete : ignored**

The **ESC** (Escape) instruction is no longer supported. All numeric coprocessor instructions are now supported directly by the assembler.

**A2206 missing operator in expression**

An expression cannot be evaluated because it is missing an operator. This error message may also be a side-effect of a preceding program error.

The following line will generate this error:

```
value1 = ( 1 + 2 ) 3
```

**A2207 missing right parenthesis in expression**

An expression cannot be evaluated because it is missing a right (closing) parenthesis. This error message may also be a side-effect of a preceding program error.

The following line will generate this error:

```
value1 = ( ( 1 + 2 ) * 3
```

**A2208 missing left parenthesis in expression**

An expression cannot be evaluated because it is missing a left (opening) parenthesis. This error message may also be a side-effect of a preceding program error.

The following line will generate this error:

```
value1 = ( ( 1 + 2 ) * 3 ) )
```

**A2209 reference to forward macro redefinition**

A macro cannot be accessed because it has not been yet defined.

Move the macro definition ahead of all references to the macro.

**A2901 cannot run ML.EXE**

The MASM driver could not spawn ML.EXE.

One of the following may have occurred:

- ◆ ML.EXE was not in the path.
- ◆ The READ attribute was not set on ML.EXE.
- ◆ There was not enough memory.

## ML Warnings

**A4000 cannot modify READONLY segment**

An attempt was made to modify an operand in a segment marked with the READONLY attribute.

**A4002 non-unique STRUCT/UNION field used without qualification**

A **STRUCT** or **UNION** field can be referenced without qualification only if it has a unique identifier.

This conflict can be resolved either by renaming one of the structure fields to make it unique or by fully specifying both field references.

The **NONUNIQUE** keyword requires that all references to the elements of a **STRUCT** or **UNION** be fully specified.

**A4003 start address on END directive ignored with .STARTUP**

Both **.STARTUP** and a program load address (optional with the **END** directive) were specified. The address specification with the **END** directive was ignored.

**A4004 cannot ASSUME CS**

An attempt was made to assume a value for the CS register. CS is always set to the current segment or group.

**A4005 unknown default prologue argument**

An unknown argument was passed to the default prologue.

The default prologue understands only the **FORCEFRAME** and **LOADDS** arguments.

**A4006 too many arguments in macro call**

There were more arguments given in the macro call than there were parameters in the macro definition.

**A4007 option untranslated, directive required : *option***

There is no ML command-line equivalent for the given MASM option. The desired behavior can be obtained by using a directive in the source file.

<b>Option</b>	<b>Directive</b>
/A	.ALPHA
/P	OPTION READONLY
/S	.SEQ

**A4008 invalid command-line option value, default is used : *option***

The value specified with the given option was not valid. The option was ignored, and the default was assumed.

**A4009 insufficient memory for /EP : /EP ignored**

There is not enough memory to generate a first-pass listing.

**A4010 expected '>' on text literal**

A macro was called with a text literal argument that was missing a closing angle bracket.

- A4011 multiple .MODEL directives found : .MODEL ignored**  
More than one **.MODEL** directive was found in the current module. Only the first **.MODEL** statement is used.
- A4012 line number information for segment without class 'CODE'**  
There were instructions in a segment that did not have a class name that ends with "CODE." The assembler did not generate CodeView information for these instructions.  
CodeView cannot process modules with code in segments with class names that do not end with "CODE."
- A4013 instructions and initialized data not supported in AT segments**  
An instruction or initialized data was found in a segment defined with the AT attribute. The code or data will not be loaded at run time.  
Data in AT segments must be declared with the ? initializer.
- A4910 cannot open file: *filename***  
The given filename could not be in the current path.  
Make sure that *filename* was copied from the distribution disks and is in the current path.
- A5000 @@: label defined but not referenced**  
A jump target was defined with the @@: label, but the target was not used by a jump instruction.  
One common cause of this error is insertion of an extra @@: label between the jump and the @@: label that the jump originally referred to.
- A5001 expression expected, assume value 0**  
There was an **IF**, **ELSEIF**, **IFE**, **IFNE**, **ELSEIFE**, or **ELSEIFNE** directive without an expression to evaluate. The assembler assumes a 0 for the comparison expression.
- A5002 externdef previously assumed to be external**  
The **OPATTR** or **.TYPE** operator was applied to a symbol after the symbol was used in an **EXTERNDEF** statement but before it was declared. These operators were used on a line where the assembler assumed that the symbol was external.
- A5003 length of symbol previously assumed to be different**  
The **LENGTHOF**, **LENGTH**, **SIZEOF**, or **SIZE** operator was applied to a symbol after the symbol was used in an **EXTERNDEF** statement but before it was declared. These operators were used on a line where the assembler assumed that the symbol had a different length and size.
- A5004 symbol previously assumed to not be in a group**  
A symbol was used in an **EXTERNDEF** statement outside of a segment and then was declared inside a segment.

- A5005 types are different**  
The type given by an **INVOKE** statement differed from that given in the procedure prototype. The assembler performed the appropriate type conversion.
- A6001 no return from procedure**  
A **PROC** statement generated a prologue, but there was no **RET** or **IRET** instruction found inside the procedure block.
- A6003 conditional jump lengthened**  
A conditional jump was encoded as a reverse conditional jump around a near unconditional jump.  
You may be able to rearrange code to avoid the longer form.
- A6004 procedure argument or local not referenced**  
You passed a procedure argument or created a variable with the **LOCAL** directive that was not used in the procedure body.  
Unnecessary parameters and locals waste code and stack space.
- A6005 expression condition may be pass-dependent**  
Under the **/Zm** command-line option or the **OPTION M510** directive, the value of an expression changed between passes.  
This error message may indicate that the code is pass-dependent and must be rewritten.

## NMAKE Error Messages

This section lists error messages generated by the NMAKE utility.

Microsoft Program Maintenance Utility (NMAKE) generates the following error messages:

- ◆ Fatal errors (U1000 through U1099) cause NMAKE to stop execution.
- ◆ Errors (U2001) do not stop execution but prevent NMAKE from completing the make process.
- ◆ Warnings (U4001 through U4011) indicate possible problems in the make process.

## NMAKE Fatal Error Messages

- U1000 syntax error : ')' missing in macro invocation**  
A left parenthesis, (, appeared without a matching right parenthesis, ), in a macro invocation. The correct form is  $\$(name)$ , and  $\$n$  is allowed for one-character names.

**U1001 syntax error : illegal character *character* in macro**

The given character appeared in a macro but was not a letter, number, or underscore (`_`).

If the colon (`:`) is omitted in a macro expansion, the following error occurs:

```
syntax error : illegal character '=' in macro
```

**U1002 syntax error : invalid macro invocation '\$'**

A single dollar sign (`$`) appeared without a macro name associated with it.

The correct form is `$(name)`. To specify a dollar sign, use a double dollar sign (`$$`) or precede it with a caret (`^`).

**U1003 syntax error : '=' missing in macro substitution**

A macro invocation contained a colon (`:`), which begins a substitution, but it did not contain an equal sign (`=`).

The correct form is:

```
$(macroname:oldstring=newstring)
```

**U1004 syntax error : macro name missing**

One of the following occurred:

- ◆ The name of a macro being defined was itself a macro invocation that expanded to nothing. For example, if the macro named `ONE` is undefined or has a null value, the following macro definition causes this error:

```
$(ONE)=TWO
```

- ◆ A macro invocation did not specify a name in the parentheses. The following specification causes this error:

```
$( )
```

The correct form is:

```
$(name)
```

**U1005 syntax error : text must follow ':' in macro**

A string substitution was specified for a macro, but the string to be changed in the macro was not specified.

**U1006 syntax error : missing closing double quotation mark**

An opening double quotation mark (`"`) appeared without a closing double quotation mark.

- U1007 double quotation mark not allowed in name**  
The specified target name or filename contained a double quotation mark (").  
Double quotation marks can surround a filename but cannot be contained within it.
- U1017 unknown directive *!directive***  
The specified directive is not one of the recognized directives.
- U1018 directive and/or expression part missing**  
The directive was incompletely specified.  
The expression part of the directive is required.
- U1019 too many nested !IF blocks**  
The limit on nesting of !IF directives was exceeded.  
The !IF preprocessing directives include !IF, !IFDEF, !IFNDEF, !ELSE IF, !ELSE IFDEF, and !ELSE IFNDEF.
- U1020 end-of-file found before next directive**  
An expected directive was missing.  
For example, an !IF was not followed by an !ENDIF.
- U1021 syntax error : !ELSE unexpected**  
An !ELSE directive was found that was not preceded by an !IF directive, or the directive was placed in a syntactically incorrect place.  
The !IF preprocessing directives include !IF, !IFDEF, !IFNDEF, !ELSE IF, !ELSE IFDEF, and !ELSE IFNDEF.
- U1022 missing terminating character for string/program invocation : *char***  
The closing double quotation mark (") in a string comparison in a directive was missing, or the closing bracket (]) in a program invocation in a directive was missing.
- U1023 syntax error in expression**  
An expression was invalid.  
Check the allowed operators and operator precedence.
- U1024 illegal argument to !CMDSWITCHES**  
An unrecognized command switch was specified.
- U1031 filename missing (or macro is null)**  
An !INCLUDE directive was found, but the name of the file to be included was missing or a macro representing the filename expanded to nothing.



**U1033 syntax error : *string* unexpected**

The given string is not part of the valid syntax for a makefile.

The following are examples of causes and results of this error:

- ◆ If the closing set of angle brackets for an inline file are not at the beginning of a line, the following error occurs:

```
syntax error : 'EOF' unexpected
```

- ◆ If a macro definition in the makefile contained an equal sign (=) without a preceding name or if the name being defined is a macro that expands to nothing, the following error occurs:

```
syntax error : '=' unexpected
```

- ◆ If the semicolon (;) in a comment line in TOOLS.INI is not at the beginning of the line, the following error occurs:

```
syntax error : ';' unexpected
```

- ◆ If the makefile has been formatted by a word processor, the following error can occur:

```
syntax error : ':' unexpected
```

**U1034 syntax error : separator missing**

The colon (:) that separates targets and dependents is missing.

**U1035 syntax error : expected ':' or '=' separator**

Either a colon (:) or an equal sign (=) was expected.

Possible causes include the following:

- ◆ A target was not followed by a colon.
- ◆ A single-letter target was followed by a colon and no space (such as a:). NMAKE interpreted it as a drive specification.
- ◆ An inference rule was not followed by a colon.
- ◆ A macro definition was not followed by an equal sign.
- ◆ A character followed a backslash (\) that was used to continue a command to a new line.
- ◆ A string appeared that did not follow any NMAKE syntax rule.
- ◆ The makefile was formatted by a word processor.

**U1036 syntax error : too many names to left of '='**

Only one string is allowed to the left of a macro definition.

- U1037**     **syntax error : target name missing**  
A colon (:) was found before a target name was found.  
At least one target is required.
- U1038**     **internal error : lexer**  
Note the circumstances of the error and notify Microsoft Corporation by following the instructions in the “Microsoft Support Services” section of the introduction to this book.
- U1039**     **internal error : parser**  
Note the circumstances of the error and notify Microsoft Corporation by following the instructions in the “Microsoft Support Services” section of the introduction to this book.
- U1040**     **internal error : macro expansion**  
Note the circumstances of the error and notify Microsoft Corporation by following the instructions in the “Microsoft Support Services” section of the introduction to this book.
- U1041**     **internal error : target building**  
Note the circumstances of the error and notify Microsoft Corporation by following the instructions in the “Microsoft Support Services” section of the introduction to this book.
- U1042**     **internal error : expression stack overflow**  
Note the circumstances of the error and notify Microsoft Corporation by following the instructions in the “Microsoft Support Services” section of the introduction to this book.
- U1043**     **internal error : temp file limit exceeded**  
Note the circumstances of the error and notify Microsoft Corporation by following the instructions in the “Microsoft Support Services” section of the introduction to this book.
- U1045**     **spawn failed : *message***  
A program or command, called by NMAKE, failed for the given reason.
- U1047**     **argument before ')' expands to nothing**  
The parentheses following the preprocessing operator **DEFINED** or **EXIST** either were empty or contained an argument that evaluated to a null string.
- U1048**     **cannot write to file *filename***  
NMAKE could not write to the given file.  
One cause of this error is a read-only file specified with /X.
- U1049**     **macro or inline file too long (maximum : 64K)**  
An inline file or a macro exceeded the limit of 64K.
- U1050**     ***user-specified text***  
The message specified with the **!ERROR** directive was displayed.

- U1051 out of memory**  
The makefile was too large or complex for available memory.
- U1052 file *filename* not found**  
NMAKE could not find the given file, which was specified with one of the following:
- ◆ The /F option
  - ◆ The **!INCLUDE** preprocessing directive
  - ◆ The at sign (@) specifier for a response file
- Check that the file exists and the filename is spelled correctly.
- U1053 file *filename* unreadable**  
The file cannot be read.  
One of the following may be a cause:
- ◆ The file is in use by another process.
  - ◆ A bad area exists on disk.
  - ◆ A bad file-allocation table exists.
- U1054 cannot create inline file *filename***  
NMAKE failed to create the given inline file.  
One of the following may be a cause:
- ◆ A file by that name exists with a read-only attribute.
  - ◆ The disk is full.
- U1055 out of environment space**  
The operating system ran out of room for environment variables.  
Either increase the environment space or set fewer environment variables.
- U1056 cannot find command processor**  
The command processor was not in the path specified in the COMSPEC or PATH environment variables.  
NMAKE uses COMMAND.COM or CMD.EXE as a command processor when executing commands. It looks for the command processor first in the path set in COMSPEC. If COMSPEC does not exist, NMAKE searches the directories specified in PATH.
- U1057 cannot delete temporary file *filename***  
NMAKE failed to delete the temporary inline file.
- U1058 terminated by user**  
NMAKE was halted by CTRL+C or CTRL+BREAK.

**U1059 syntax error: '}' missing in dependent**

A search path for a dependent was incorrectly specified. Either a space existed in the path or the closing brace (}) was omitted. The syntax for a directory specification for a dependent is:

```
{directories}dependent
```

where *directories* specifies one or more paths, each separated by a semicolon (;). No spaces are allowed.

If part or all of a search path is replaced by a macro, be sure that no spaces exist in the macro expansion.

**U1060 unable to close file : *filename***

NMAKE encountered an error while closing a file.

One of the following may be a cause:

- ◆ The file is a read-only file.
- ◆ There is a locking or sharing violation.
- ◆ The disk is full.

**U1061 /F option requires a filename**

The /F command-line option must be followed by either a makefile name or a dash (-), which represents standard input.

**U1062 missing filename with /X option**

The /X command-line option requires the name of the file to which diagnostic error output should be redirected.

To use standard output, specify '-' as the output filename.

**U1063 missing macro name before '='**

A macro definition on the NMAKE command line contained an equal sign (=) without a preceding name.

This error can occur if the macro name being defined is itself a macro that expands to nothing.

**U1064 MAKEFILE not found and no target specified**

The NMAKE command line did not specify a makefile or a target, and the current directory did not contain a file named MAKEFILE.

NMAKE requires either a makefile or a command-line target. To make a makefile available to NMAKE, either specify the /F option or place a file named MAKEFILE in the current directory. NMAKE can create a command-line target by using an inference rule if a makefile is not provided.

**U1065 invalid option *option***

The specified option is not a valid option for NMAKE.

**U1069**    **no match found for wildcard** *filename*

There is no file that matches the given filename, which was specified using one or more wildcards (\* and ?).

A target file specified using a wildcard must exist on disk.

**U1070**    **cycle in macro definition** *macroname*

The given macro definition contained a macro whose definition contained the given macro. Circular macro definitions are invalid.

For example, the following macro definitions:

```
ONE=$ (TWO)
TWO=$ (ONE)
```

cause the following error:

```
cycle in macro definition 'TWO'
```

**U1071**    **cycle in dependency tree for target** *targetname*

A circular dependency exists in the dependency tree for the given target. The given target is a dependent of one of the dependents of the given target. Circular dependencies are invalid.

**U1072**    **cycle in include files :** *filename*

The given file includes a file that eventually includes the given file. Inclusions (using the **!INCLUDE** preprocessing directive) cannot be circular.

**U1073**    **don't know how to make** *targetname*

The specified target does not exist, and there is no command to execute or inference rule to apply.

One of the following may be a solution:

- ◆ Check the spelling of the target name.
- ◆ If *targetname* is a pseudotarget, specify it as a target in another description block.
- ◆ If *targetname* is a macro invocation, be sure it does not expand to a null string.

**U1076**    **name too long**

A string exceeded one of the following limits:

- ◆ A macro name cannot exceed 1024 characters.
- ◆ A target name (including path) cannot exceed 256 characters.
- ◆ A command cannot exceed 2048 characters.

**U1077**     *program* : **return code value**

The given command or program called by NMAKE failed and returned the given exit code.

To suppress this error and continue the NMAKE session, use the /I option, the **.IGNORE** dot directive, or the dash (–) command modifier. To continue the NMAKE session for unrelated parts of the dependency tree, use the /K option.

**U1078**     **constant overflow at** *expression*

The given expression contained a constant that exceeded the range –2,147,483,648 to 2,147,483,647. The constant appeared in one of the following situations:

- ◆ An expression specified with a preprocessing directive
- ◆ An error level specified with the dash (–) command modifier

**U1079**     **illegal expression : divide by zero**

An expression tried to divide by zero.

**U1080**     **operator and/or operand usage illegal**

The expression incorrectly used an operator or operand.

Check the allowed set of operators and their order of precedence.

**U1081**     *filename* : **program not found**

NMAKE could not find the given program in order to run it.

Make sure that the program is in a directory specified in the PATH environment variable and is not misspelled.

**U1082**     *command* : **cannot execute command; out of memory**

There is not enough memory to execute the given command.

**U1083**     **target macro** *target* **expands to nothing**

The given target is an invocation of a macro that has not been defined or has a null value. NMAKE cannot process a null target.

**U1084**     **cannot create temporary file** *filename*

NMAKE was unable to create the temporary file it needs when it processes the makefile.

One of the following may be a cause:

- ◆ The file already exists with a read-only attribute.
- ◆ There is insufficient disk space to create the file.
- ◆ The directory specified in the TMP environment variable does not exist.

**U1085**     **cannot mix implicit and explicit rules**

A target and a pair of inference-rule extensions were specified on the same line. Targets cannot be named in inference rules.

**U1086 inference rule cannot have dependents**

The colon (:) in an inference rule must be followed by one of the following:

- ◆ A newline character
- ◆ A semicolon (;), which can be followed by a command
- ◆ A number sign (#), which can be followed by a comment

**U1087 cannot have : and :: dependents for same target**

A target cannot be specified in both a single-colon (:) and a double-colon (::) dependency. To specify a target in multiple description blocks, use :: in each dependency line.

**U1088 invalid separator '::' on inference rule**

An inference rule must be followed by a single colon (:).

**U1089 cannot have build commands for directive *targetname***

Dot directives cannot be followed by commands. The dot directives are **.IGNORE**, **.PRECIOUS**, **.SILENT**, and **.SUFFIXES**.

**U1090 cannot have dependents for directive *targetname***

Dot directives cannot be followed by dependents. The dot directives are **.IGNORE**, **.PRECIOUS**, **.SILENT**, and **.SUFFIXES**.

**U1092 too many names in rule**

An inference rule cannot specify more than two extensions.

**U1093 cannot mix dot directives**

Multiple dot directives cannot be specified on one line. The dot directives are **.IGNORE**, **.PRECIOUS**, **.SILENT**, and **.SUFFIXES**.

**U1094 syntax error : only (NO)KEEP allowed here**

Something other than **KEEP** or **NOKEEP** appeared after the closing set of angle brackets (<<) specifying an inline file. Only **KEEP**, **NOKEEP**, or a newline character may follow the angle brackets. No spaces, tabs, or other characters may appear.

**KEEP** preserves the inline file on disk. **NOKEEP** deletes the file after the NMAKE session. The default is **NOKEEP**.

**U1095 expanded command line *commandline* too long**

After macro expansion, the given command line exceeded the limit on length of command lines for the operating system.

MS-DOS permits up to 128 characters on a command line.

If the command is for a program that can accept command-line input from a file, change the command and supply input from either a file on disk or an inline file. For example, **LINK** and **LIB** accept input from a response file.

**U1096**     **cannot open inline file** *filename*

NMAKE could not create the given inline file.

One of the following occurred:

- ◆ The disk was full.
- ◆ A file with that name exists as a read-only file.

**U1097**     **filename-parts syntax requires dependent**

The current dependency does not have either an explicit dependent or an implicit dependent. Filename-parts syntax, which uses the percent (%) specifier, represents components of the first dependent of the current target.

**U1098**     **illegal filename-parts syntax in** *string*

The given string does not contain valid filename-parts syntax.

**U1099**     The makefile being processed was too complex for the current stack allocation in NMAKE. NMAKE has an allocation of 0x3000 (12K).

To increase NMAKE's stack allocation, run the EXEHDR utility with a larger stack option:

```
EXEHDR /STACK:stacksize
```

where `stacksize` is a number greater than the current stack allocation in NMAKE.

## NMAKE Error Messages

**U2001**     **no more file handles (too many files open)**

NMAKE could not find a free file handle.

One of the following may be a solution:

- ◆ Reduce recursion in the build procedures.
- ◆ In MS-DOS, increase the number of file handles by changing the FILES setting in CONFIG.SYS to allow a larger number of open files. FILES=50 is the recommended setting.

## NMAKE Warning Messages

**U4001**     **command file can be invoked only from command line**

A command file, which is invoked by the at sign (@) specifier, cannot contain a specification for another command file. Such nesting is not allowed. The specification was ignored.

**U4002**     **resetting value of special macro** *macroname*

The given predefined macro was redefined.



- U4004**    **too many rules for target** *targetname*  
More than one description block was specified for the given target using single colons (:) as separators. NMAKE executed the commands in the first description block and ignored later blocks.  
To specify the same target in multiple dependencies, use double colons (::) as the separator in each dependency line.
- U4005**    **ignoring rule** *rule* **(extension not in .SUFFIXES)**  
The given rule contained a suffix that is not specified in the **.SUFFIXES** list. NMAKE ignored the rule.  
This warning appears only when the /P option is used.
- U4006**    **special macro undefined :** *macroname*  
The given special macro name is undefined and expands to nothing.
- U4007**    **filename** *filename* **too long; truncating to 8.3**  
The base name of the given file has more than 8 characters, or the extension has more than three characters. NMAKE truncated the name to an 8-character base and a 3-character extension.  
If long filenames are supported by your file system, enclose the name in double quotation marks ("").
- U4008**    **removed target** *target*  
NMAKE was interrupted while trying to build the given target, and the target file was incomplete. Because the target was not specified in the **.PRECIOUS** list, NMAKE deleted the file.
- U4010**    **target : build failed; /K specified, continuing ...**  
A command in the commands block for the given target returned a nonzero exit code. The /K option told NMAKE to continue processing unrelated parts of the build and to issue an exit code 1 when the NMAKE session is finished.  
If the given target is itself a dependent for another target, NMAKE issues warning U4011 after this warning.
- U4011**    **target : not all dependents available; target not built**  
A dependent of the given target either did not exist or was out of date, and a command for updating the dependent returned a nonzero exit code. The /K option told NMAKE to continue processing unrelated parts of the build and to issue an exit code 1 when the NMAKE session is finished.  
This warning is preceded by warning U4010 for each dependent that failed to be created or updated.

## PWB Error Messages

PWB displays an error message whenever it detects a command it cannot execute. Most errors terminate the command that is in error, but do not terminate PWB.

For most errors, PWB displays a message box with only the text of the message. The error number does not appear. With these messages, press F1 or click Help when the message box is displayed for Help on the error. Some errors terminate PWB. PWB displays these fatal errors on the command line after returning to the operating system.

This section lists only the fatal PWB errors.

### PWB Fatal Errors

**PWB3089      Out of local memory. Unable to recover.**

PWB has run out of memory and cannot recover. This is a fatal PWB condition. However, PWB is able to save your files, and you can restart PWB to continue.

This can happen when using PWB continuously for a long time.

This can also happen when creating a project with a very large number of files or adding files to a large project. To make the largest amount of memory available to PWB for creating a very large project, load only the PWBUTILS extension and only the language extensions you need for the project. Start PWB with the /DS option, and create the project before doing any other work.

If the project is too large for PWB to handle as a PWB project, you can use a non-PWB makefile for your project.

**PWB3090      Out of virtual memory space. Unable to recover.**

PWB has run out of virtual memory and cannot recover. This is a fatal PWB condition. However, PWB is able to save your files, and you can restart PWB to continue.

**PWB3096      Unsupported video mode. Please change modes and restart.**

A request was made to start PWB with the **Savescreen** switch set to yes (the default), but PWB does not support the current operating-system video mode.

Change the video mode and restart PWB.

- PWB3178**     **Cannot start: unable to open swapping file**  
PWB is unable to create its virtual-memory file on disk.  
PWB creates this file in the directory pointed to by the TMP environment variable. If no TMP environment variable is set, PWB creates the file in the current directory.  
Check that the disk has at least 2 free megabytes and that the directory can be accessed with permission to create a file. Check that the TMP environment variable lists a single existing directory.
- PWB3180**     **Cannot start: not enough far memory**  
PWB ran out of memory while starting up.  
Make more memory available to PWB and restart PWB.
- PWB3181**     **Cannot initialize**  
PWB cannot initialize itself.  
Check that there is enough memory available for PWB. Also, check that there is no conflict with a TSR (terminate-and-stay-resident) program.
- PWB3901**     **RE: error *number*, line *line***  
PWB has encountered an error while processing a regular expression. The expression may be malformed or too complex.  
Check that the syntax of the regular expression is correct.
- PWB3909**     **RemoveFile can't find file**  
PWB has encountered an internal error.  
Note the circumstances of the error and notify Microsoft Corporation by following the instructions in the "Microsoft Support Services" section of the introduction to this book.
- PWB3912**     **Internal VM Error**  
PWB has encountered an internal error.  
Note the circumstances of the error and notify Microsoft Corporation by following the instructions in the "Microsoft Support Services" section of the introduction to this book.
- PWB12078**    **Cannot access *file*: *reason***  
PWB cannot access the given file for the stated reason.  
Correct the situation and restart PWB.
- PWB12086**    **Cannot access TMP directory: *reason***  
PWB cannot access the directory listed in the TMP environment variable for the stated reason.  
Correct the situation and restart PWB.

## SBRPACK Error Messages

This section lists error messages generated by the Microsoft Browse Information Compactor (SBRPACK). SBRPACK errors (SB *xxx*) are always fatal.

### **SB1000 UNKNOWN ERROR**

#### **Contact Microsoft Product Support Services**

SBRPACK detected an unknown error condition.

Note the circumstances of the error and notify Microsoft Corporation by following the instructions in the “Microsoft Support Services” section of the introduction to this book.

This error ends SBRPACK with exit code 1.

### **SB1001 *option* : unknown option**

SBRPACK did not recognize the given option.

This error ends SBRPACK with exit code 1.

### **SB1002 *sbrfile* : corrupt file**

The given .SBR file is corrupt or does not have the expected format.

Recompile to regenerate the .SBR file.

This error ends SBRPACK with exit code 2.

### **SB1003 *sbrfile* : invalid .SBR file**

SBRPACK did not recognize the given file as an .SBR file.

One of the following may be a solution:

- ◆ Check the spelling of the specified file.
- ◆ Recompile to regenerate the .SBR file.

This error ends SBRPACK with exit code 2.

**SB1004** *sbrfile* : incompatible .SBR version

The given .SBR file cannot be packed by this version of SBRPACK.

One of the following may be a cause:

- ◆ The .SBR file was created by a compiler that is not compatible with this version of SBRPACK.
- ◆ The .SBR file is corrupt.

This error ends SBRPACK with exit code 2.

**SB1005** *sbrfile* : cannot open file

SBRPACK cannot open the given .SBR file.

One of the following may be a cause:

- ◆ The .SBR file does not exist. Check the spelling.
- ◆ The .SBR file was locked by another process.

This error ends SBRPACK with exit code 3.

**SB1006** cannot create temporary .SBR file

One of the following may have occurred:

- ◆ No more file handles were available. Increase the number of file handles by changing the FILES setting in CONFIG.SYS to allow a larger number of open files. FILES=50 is recommended.
- ◆ The disk was full.

This error ends SBRPACK with exit code 4.



## A P P E N D I X B

## Regular Expressions

A regular expression (sometimes called a “pattern”) is a find string that uses special characters to match patterns of text. You can use regular expressions to find patterns such as 5-digit numbers or strings in quotation marks. Selected portions of found text can be used in a replacement.

In PWB you can specify regular expressions in two ways: UNIX syntax and non-UNIX syntax. UNIX regular expressions have a syntax similar to regular expressions in the UNIX and XENIX operating systems. CodeView uses a subset of the UNIX regular-expression syntax. Non-UNIX regular-expression syntax has the features of UNIX regular expressions but includes additional features and uses a more compact syntax.

The **Unixre** switch determines whether PWB uses UNIX or non-UNIX regular expressions in searches. PWB switches that accept regular expressions, such as **Build** and **Word**, always use UNIX syntax.

## Regular-Expression Summaries

The following table summarizes PWB’s UNIX regular-expression syntax.

**Table B.1 UNIX Regular-Expression Summary**

Syntax	Description
\c	Escape: literal character <i>c</i>
.	Wildcard: any character
^	Beginning of line
\$	End of line
[ <i>class</i> ]	Character class: any one character in set
[^ <i>class</i> ]	Inverse class: any one character not in set
<i>x</i> *	Repeat: zero or more occurrences of <i>x</i>
<i>x</i> +	Repeat: one or more occurrences of <i>x</i>

**Table B.1** UNIX Regular-Expression Summary (*continued*)

Syntax	Description
\{x\}	Grouping: group subexpression for repetition
\{x!y!z\}	Alternation: match one from the set
\~x	“Not”: fail if <i>x</i> at this point
\(x\)	Tagged expression
\n	Reference to tagged expression number <i>n</i>
\:e	Predefined expression

The following table summarizes the UNIX predefined expressions.

**Table B.2** UNIX Predefined Expressions

Syntax	Description
\:a	Alphanumeric character
\:b	White space
\:c	Alphabetic character
\:d	Digit
\:f	Part of a filename
\:h	Hexadecimal number
\:i	Microsoft C/C++ identifier
\:n	Unsigned number
\:p	Path
\:q	Quoted string
\:w	English word
\:z	Unsigned integer

CodeView uses a subset of the UNIX regular-expression syntax. You can use regular expressions as arguments to the Search (*/*) command and Examine Symbols (*X*) command. The following table summarizes CodeView regular expressions.



**Table B.3 CodeView Regular Expressions**

Character	Syntax	Meaning
Backslash	\c	Matches a literal character <i>c</i> . (Escape)
Period	.	Matches any single character. (Wildcard)
Caret	^	Matches the beginning of a line. The caret must appear at the beginning of the pattern.
Dollar sign	\$	Matches the end of a line. The dollar sign must appear at the end of the pattern.
Asterisk	c*	Matches zero or more occurrences of <i>c</i> .
Brackets	[...]	Matches any one character in the set of the characters within the brackets.

Within the brackets, you can specify a negated set and ranges of characters by using the following notation:

Character	Syntax	Meaning
Dash	-	Specifies a range of characters in the ASCII order between the characters on either side, inclusive. For example, [a-z] matches the lowercase alphabet.
Caret	^	Matches any one character not within the brackets. The caret must be the first character within the brackets. For example, [^0-9] matches any character except a digit.

The following table summarizes the non-UNIX regular-expression syntax.

**Table B.4 Non-UNIX Regular-Expression Summary**

Syntax	Description
\c	Escape: literal character <i>c</i>
?	Wildcard: any character
^	Beginning of line
\$	End of line
[class]	Character class: any one character in set
[~class]	Inverse class: any one character not in set
x*	Repeat: zero or more occurrences of <i>x</i>
x+	Repeat: one or more occurrences of <i>x</i>
x@	Repeat: maximal zero or more occurrences of <i>x</i>
x#	Repeat: maximal one or more occurrences of <i>x</i>
(x)	Grouping: group subexpression for repetition
(x!y!z)	Alternation: match one from the set

**Table B.4 Non-UNIX Regular-Expression Summary** (*continued*)

Syntax	Description
<code>~x</code>	“Not”: fail if <i>x</i> at this point
<code>x^n</code>	“Power”: match <i>n</i> copies of <i>x</i>
<code>{x}</code>	Tagged expression
<code>\$n</code>	Reference to tagged expression number <i>n</i>
<code>:e</code>	Predefined expression

The following table summarizes the non-UNIX predefined expressions.

**Table B.5 Non-UNIX Predefined Expressions**

Syntax	Description
<code>:a</code>	Alphanumeric character
<code>:b</code>	White space
<code>:c</code>	Alphabetic character
<code>:d</code>	Digit
<code>:f</code>	Part of a filename
<code>:h</code>	Hexadecimal number
<code>:i</code>	Microsoft C/C++ identifier
<code>:n</code>	Unsigned number
<code>:p</code>	Path
<code>:q</code>	Quoted string
<code>:w</code>	English word
<code>:z</code>	Unsigned integer

## UNIX Regular-Expression Syntax

PWB uses the following UNIX-style regular-expression syntax:

**Table B.6 UNIX Regular-Expression Syntax**

Syntax	Description
<code>\c</code>	Escape: matches a literal occurrence of the character <i>c</i> and ignores any special meaning of <i>c</i> in a regular expression. For example, the expression <code>\?</code> matches a question mark (?), <code>\^</code> matches a caret (^), and <code>\\</code> matches a backslash (\).
<code>.</code>	Wildcard: matches any single character. For example, the expression <code>a.a</code> matches <code>aaa</code> and <code>a0a</code> .

**Table B.6** UNIX Regular-Expression Syntax (*continued*)

Syntax	Description
<code>^</code>	Beginning of line. For example, the expression <code>^The</code> matches the word <code>The</code> only when it occurs at the beginning of a line.
<code>\$</code>	End of line. For example, the expression <code>end\$</code> matches the word <code>end</code> only when it occurs at the end of a line.
<code>[class]</code>	Character class: matches any one character in the class. Use a dash ( <code>-</code> ) to specify a range of characters. Within a class, all characters except <code>^-\ are treated literally. For example, <code>[a-zA-Z0-9]</code> matches any character or digit, and <code>[abc]</code> matches <code>a</code>, <code>b</code>, or <code>c</code>.</code>
<code>[^class]</code>	Inverse of character class: matches any character not specified in the class. For example, <code>[^0-9]</code> matches any character that is not a digit.
<code>x*</code>	Repeat operator: matches zero or more occurrences of <code>x</code> , where <code>x</code> is a single character, a character class, or a grouped expression. For example, the regular expression <code>ba*b</code> matches <code>baaab</code> , <code>bab</code> , and <code>bb</code> . This operator always matches as many characters as possible.
<code>x+</code>	Repeat operator (shorthand for <code>xx*</code> ): matches one or more occurrences of <code>x</code> . For example, the regular expression <code>ba+b</code> matches <code>baab</code> and <code>bab</code> but not <code>bb</code> .
<code>\(x\)</code>	Tagged expression: marked text, which you can refer to as <code>\n</code> elsewhere in the find or replacement string. Within a find string, PWB finds text that contains the previously tagged text. Within a replacement string, PWB reuses the matched text in the replacement.
<code>\n</code>	References the characters matched by a tagged expression, where <code>n</code> is a one-digit number and indicates which expression. The first tagged expression is <code>\1</code> , the second is <code>\2</code> , and so on. The entire expression is represented as <code>\0</code> .
<code>\{x\}</code>	Grouping. Groups a regular expression so that you can use a repeat operator on the subexpression. For example, the regular expression <code>\{Test\}+</code> matches <code>Test</code> and <code>TestTest</code> .
<code>\{x!y!z\}</code>	Alternation: matches one from a set of alternate patterns. The alternates are tried in left-to-right order. The next alternate is tried only when the rest of the pattern fails. For example, <code>\{ +\!\$\}</code> matches a sequence of blanks or the end of a line.
<code>\~x</code>	“NOT” function: matches nothing but checks to see whether the text matches <code>x</code> at this point and fails if it does. For example, <code>^\~\{ \!\$\}</code> . <code>*</code> matches all lines that do not begin with white space or end of line.
<code>\:e</code>	Predefined regular expression, where <code>e</code> is a letter specifying the regular expression.

**Examples**

In PWB, to find the next occurrence of a number (a string of digits) that begins with the digit 1 or 2:

1. Execute **Arg Arg** (ALT+A ALT+A)
2. Type `[12][0-9]*`
3. Execute **Psearch** (F3)

The special characters in regular expression syntax are most powerful when they are used together. For example, the following combination of the wildcard (.) and repeat (\*) characters

`.*`

matches any string of characters. This expression is useful when it is part of a larger expression, such as

`B.*ing`

which matches any string beginning with `B` and ending with `ing`.

## Tagged Regular Expressions

Tagged expressions are regular expressions enclosed by the delimiters `\` and `\` (UNIX) or `{` and `}` (non-UNIX). Use tagged expressions to match repeated elements and to mark substrings for use in a replacement. Note that a tagged expression is not the same as a grouped expression.

When you specify a regular expression with tagged subexpressions, PWB finds text that matches the regular expression and marks each substring matching a tagged subexpression.

**Example**

The UNIX regular expression

`\(<\)\([^>]+\)\(>\)`

matches the string

`<bracketed>`

and tags the `<`, `bracketed`, and `>` substrings.

To refer to tagged text in a find or replacement pattern, use `\1` (UNIX) or `$n` (non-UNIX), where `n` is the number of a tagged subexpression from 1 to 9. In a find pattern, this reference matches another occurrence of the previously matched text, not another occurrence of the regular expression. In a replacement, PWB uses the matched text.

The entire match is implicitly tagged for use in replacement text. Use **\0** (UNIX) or **\$0** (non-UNIX) to refer to the entire match. For example, the UNIX find pattern

```
^\([^ ]+\) +\([^ ]+\).*
```

with the replace pattern

```
\2 \1 (\0)
```

matches lines without leading spaces and at least two words. It replaces them with lines that consist of the transposed words followed by the original line in parentheses.

**Example**

The tagged expressions:

UNIX	Non-UNIX
<code>\([A-Za-z]+\)=\1</code>	<code>{[A-Za-z]+}==\$1</code>

match one or more letters followed by two equal signs (==) and a repetition of the letters. They match the first two strings below, but not the third:

```
ABCxyz==ABCxyz
i==i
ABCxyz==KBCxjj
```

The following example finds one or more hexadecimal digits followed by the letter H. Each matching string is replaced by a string that consists of the original digits (which were tagged so they could be reused) and the prefix 16#.

1. Find strings of the form *hexdigits*H with the UNIX and non-UNIX patterns:

UNIX	Non-UNIX
<code>\([0-9a-fA-F]+\)H</code>	<code>{[0-9a-fA-F]+}H</code>

These patterns can also be expressed by using the predefined pattern for hexadecimal digits:

UNIX	Non-UNIX
<code>\(:h*\)H</code>	<code>{:h}H</code>

2. Replace with the patterns:

UNIX	Non-UNIX
<code>16#\1</code>	<code>16#\$1</code>

## Tagged Expressions in Build:Message

PWB uses tagged UNIX regular expressions to find the location of errors and warnings displayed in the Build Results window. The tagged portions of the message indicate the file and the location or token in error.

To define new messages for PWB to recognize, add a new **Build:message** switch definition to the [PWB] section of TOOLS.INI. The syntax for this switch is:

```
Build:message "pattern" [[file [[line [[column]] ] ] | token]]
```

The pattern is a macro string that specifies a tagged UNIX regular expression. The file, line, col, and token keywords indicate the meaning of each tagged subexpression.

For example, if the messages you want to match look like:

```
Error: Missing ';' on line 123 in SAMPLE.XYZ
```

Place the following setting in TOOLS.INI:

```
Build:message "^Error: .* on line \\(\\:z\\) in \\(\\:p\\)" \\  
file line
```

Note that each backslash in the regular expression is doubled within the macro string. This pattern uses the predefined expressions for integer (**\:z**) and path (**\:p**).

## Justifying Tagged Expressions

To justify a tagged regular expression, use the following syntax in the replacement string:

UNIX	Non-UNIX
$\backslash(width,n)$	$\$(width,n)$

The *width* is the field size (negative for left justification), and *n* is the number of the tagged expression to justify.

PWB justifies the tagged text according to the following rules:

- ◆ If *width* is greater than the length of the tagged text, PWB right-justifies the tagged expression within the field and pads the field with leading spaces.
- ◆ If *width* is negative and its magnitude is greater than the length of the text, PWB left-justifies the expression and pads the field with trailing spaces.
- ◆ If *width* is less than or equal to the length of the text, PWB uses the whole text and does not pad the field. PWB never truncates justified text.



## Non-UNIX Regular-Expression Syntax

PWB uses the following non-UNIX regular-expression syntax:

**Table B.8 Non-UNIX Regular Expression Syntax**

Syntax	Description
<code>\c</code>	Escape: matches a literal occurrence of the character <i>c</i> and ignores any special meaning of <i>c</i> in a regular expression. For example, the expression <code>\?</code> matches a question mark <code>?</code> , <code>\^</code> matches a caret <code>^</code> , and <code>\\</code> matches a backslash <code>\</code> .
<code>?</code>	Wildcard: matches any single character. For example, the expression <code>a?a</code> matches <code>aaa</code> and <code>a1a</code> but not <code>aBBa</code> .
<code>^</code>	Beginning of line. For example, the expression <code>^The</code> matches the word <code>The</code> only when it occurs at the beginning of a line.
<code>\$</code>	End of line. For example, the expression <code>end\$</code> matches the word <code>end</code> only when it occurs at the end of a line.
<code>[class]</code>	Character class: matches any one character in the class. Use a dash ( <code>-</code> ) to specify a range of characters. Within a class, all characters except <code>~-\<code>\]</code> are treated literally. For example, <code>[a-zA-Z*]</code> matches any alphabetic character or asterisk, and <code>[abc]</code> matches a single <code>a</code>, <code>b</code>, or <code>c</code>.</code>
<code>[~class]</code>	Inverse of character class: matches any single character not in the class. For example, <code>[~0-9]</code> matches any character that is not a digit.
<code>x*</code>	Minimal matching: matches zero or more occurrences of <i>x</i> , where <i>x</i> is a single character or a grouped expression. For example, the expression <code>ba*b</code> matches <code>baaab</code> , <code>bab</code> , and <code>bb</code> .
<code>x+</code>	Minimal matching plus (shorthand for <code>xx*</code> ): matches one or more occurrences of <i>x</i> . For example, the expression <code>ba+b</code> matches <code>baab</code> and <code>bab</code> but not <code>bb</code> .
<code>x@</code>	Maximal matching: identical to <code>x*</code> , except that it matches as many occurrences as possible.
<code>x#</code>	Maximal matching plus: identical to <code>x+</code> , except that it matches as many occurrences as possible.
<code>(x!y!z)</code>	Alternation: matches one from a set of alternate patterns. The alternates are tried in left-to-right order. The next alternate is tried only when the rest of the pattern fails. For example, the expression <code>(ww!xx!xxyy)zz</code> matches <code>xxzz</code> on the second alternative and <code>xyyzz</code> on the third.
<code>(x)</code>	Grouping. Groups an expression so that you can use a repeat operator with the expression. For example, the expression <code>(Test)+</code> matches <code>Test</code> and <code>TestTest</code> .
<code>~x</code>	“NOT” function: matches nothing but checks to see if the text matches <i>x</i> at this point and fails if it does. For example, <code>^(if!while)?*\$</code> matches all lines that do not begin with <code>if</code> or <code>while</code> .



**Table B.8 Non-UNIX Regular Expression Syntax** (*continued*)

Syntax	Description
$x^n$	Power function: matches $n$ copies of $x$ . For example, $w^4$ matches <code>www</code> , and $(a?)^3$ matches <code>a#aba5</code> .
$\{x\}$	Tagged expression: marked text, which you can refer to as $\$n$ elsewhere in the find or replacement string. Within a find string, PWB finds text that contains the previously tagged text. Within a replacement string, PWB reuses the matched text in the replacement.
$\$n$	Reference to text matched by a tagged expression. The specific substring is indicated by $n$ . The first tagged substring is indicated as $\$1$ , the second as $\$2$ , and so on. A $\$0$ represents the entire match.
$:e$	Predefined regular expression, where $e$ is a letter that specifies the regular expression.

**Examples**

In PWB, to find the next occurrence of a number (a string of digits) that begins with the digit 1 or 2:

1. Execute **Arg Arg** (ALT+A ALT+A).
2. Type `[12][0-9]*`
3. Execute **Psearch** (F3).

Regular expressions are most powerful when they are used together. For example, the combination of the wildcard (?) and repeat (\*) operators

`?*`

matches any string of characters. This expression is useful when it is part of a larger expression, such as

`B?*ing`

which matches any string beginning with `B` and ending with `ing`.

**Non-UNIX Matching Method**

The type of non-UNIX matching method is significant only when you use a find-and-replace command. “Matching method” refers to the technique used to match repeated expressions. For example, does the expression `a*` match as few or as many characters as it can? The answer depends on the matching method.

PWB supports two matching methods in non-UNIX regular expressions:

- ◆ “Minimal matching” matches as few characters as possible to find a match. For example, `a+` matches only the first character in `aaaaa`. However, `ba+b` matches the entire string `baaaaab` because it is necessary to match every `a` to match both occurrences of `b`.
- ◆ “Maximal matching” matches as many characters as possible. For example, `a#` matches the entire string `aaaaaa`.

**Example**

If `a+` (minimal matching plus) is the find string and `EE` is the replacement string, PWB replaces `aaaaa` with `EEEEEEEEEE` because at each occurrence of `a`, PWB immediately replaces it with `EE`.

However, if `a#` (maximal matching plus) is the find string, PWB replaces the same string with `EE` because it matches the entire string `aaaaaa` at once and replaces that string with `EE`.

# Glossary

**386 enhanced mode** A mode in the Windows operating system that runs on the 80386 and 80486 processors. It provides access to extended memory and the ability to run non-Windows-based applications. This and standard mode are both referred to as protected mode in the Windows operating system and offer more capability than real mode.

**8086 family of processors** All processors in the Intel 8086 family, including the 8086, 80286, 80386, and 80486 CPU chips.

**8087 family of math processors** All math processors (also called math coprocessors) in the Intel 8087 family, including the 8087, 80287, and 80387 chips. These processors perform high-speed floating-point and binary-coded-decimal number processing. The 80486 chip includes a math processor.

**8087 window** The CodeView window in which the floating-point math processor's registers are displayed. This window remains empty until a math processor instruction is executed. If the program uses the Microsoft math processor emulator library, the contents of the emulated math processor's registers are displayed.

## A

**actual parameter** See "argument."

**adapter** A printed-circuit card that plugs into a computer and controls a device, such as a video display or a printer.

**address** The memory location of a data item or procedure, or an expression that evaluates to an address. In CodeView, the expression can

represent just the offset (a default segment is assumed), or it can be in *segment:offset* format.

**address range** A range of memory bounded by two addresses.

**anonymous allocation** Assignment to a segment at link time.

### **ANSI (American National Standards Institute)**

The institute responsible for defining programming-language standards to promote portability of languages between different computer systems.

**ANSI character set** An 8-bit character set that contains 256 characters. See "ASCII character set."

### **API (application programming interface)**

A set of system-level routines that can be used in an application program for tasks such as input, output, and file management. In a graphics-oriented operating environment like Microsoft Windows, high-level support for video graphics output is part of the API.

**argc** The conventional name for the first argument to the **main** function in a C source program (an integer specifying the number of arguments passed to the program from the command line).

**argument** A value passed to a routine or specified with an option in the command line for a utility. Also called an actual parameter. See also "parameter."

**argv** The conventional name for the second argument to the **main** function in a C source program (a pointer to an array of strings). The first string is the program name, and each following

string is an argument passed to the program from the command line.

**array** A set of elements of the same type.

**ASCII character set** The American Standard Code for Information Interchange 8-bit character set, consisting of the first 128 (0 to 127) characters of the ANSI character set. The term ASCII characters is sometimes used to mean all 256 characters defined for a particular system, including the extended ASCII characters. ASCII values represent letters, digits, special symbols, and other characters. See also “extended ASCII.”

**ASCII file** See “text file.”

**.ASM** The extension for an assembly-language source file.

**Assembly mode** The mode in which CodeView displays the assembly-language equivalent of the machine code being executed. CodeView disassembles the executable file in memory to obtain the code.

**automatic data segment** See “DGROUP.”

**available memory** The portion of conventional memory not used by system software, TSR utilities, or other programs.

## B

**.BAK** The extension that is often used to indicate a backup file.

**.BAS** The extension for a Basic language source file.

**base name** The part of a filename before the extension, usually 1 to 8 characters. For example, README is the base name of the filename README.TXT.

**.BAT** The extension for an MS-DOS batch file.

**batch file** A file containing operating-system commands that can be run from the command line. Also called a command file.

**binary file** A file that contains numbers in binary, machine-readable form. For example, an executable file is a binary file.

**binary operator** An operator that takes two operands.

## BIOS (basic input/output system)

The code built into system memory that provides hardware interface routines for programs. You can trace into the BIOS with CodeView when using Assembly mode.

**.BMP** The extension for a bitmap file.

**breakpoint** A specified address where program execution halts. CodeView interrupts execution when the program reaches the address where a breakpoint is set. See also “conditional breakpoint.”

**.BSC** The extension for a database file for use with the Source Browser. A .BSC file is created by BSCMAKE.

**buffer** An area in memory that holds data temporarily, most often during input/output operations.

## C

**.C** The extension for a C source file.

**call gate** A special descriptor-table entry that describes a subroutine entry point rather than a memory segment. A far call to a call gate selector transfers to the entry point specified in the call gate. This is a feature of the 80286–80486 hardware and is typically used to provide a transition from a lower privilege state to a higher one.

**case sensitivity** The distinction made between uppercase and lowercase letters. For example, “MyFile” and “MYFILE” are considered to be different strings in a case-sensitive situation but are understood to be the same string if case is not sensitive.

**CGA (color graphics adapter)** A video adapter capable of displaying text characters or graphics pixels in low resolution in up to 16 colors.

**character string** A sequence of bytes treated as a set of ASCII letters, numbers, and other symbols. A character string is often enclosed in single quotation marks ( ' ') or double quotation marks ( " " ).

**child process** A process created by another process (its parent process).

**click** To press and release quickly one of the mouse buttons (usually the left button) while pointing the mouse pointer to an object on the screen.

**clipboard** A temporary storage area for text. The clipboard is used for cut, copy, and paste operations.

**.COB** The extension for a COBOL source file.

**code symbol** The address of a routine.

**.COM** The extension for an MS-DOS executable file that contains a single segment. Tiny-model programs have a .COM extension. See also “tiny memory model.”

**command** An instruction you use to control a computer program, such as an operating system or application.

**command file** A file containing operating-system commands that can be run from the command line. If the file’s extension is .BAT, the command file

contains MS-DOS commands. Also called a batch file.

**command file (in NMAKE)** A text file containing input expected by utilities such as NMAKE.

**compact memory model** A program with one code segment and multiple data segments.

**compile** To translate programming language statements into a form that can be executed by the computer.

**conditional breakpoint** A breakpoint that is taken when a specified expression becomes nonzero (true). A conditional breakpoint is evaluated after every instruction is executed unless an address is also specified. Formerly called tracepoint and watchpoint.

**constant** A value that does not change during program execution.

**constant expression** Any expression that evaluates to a constant. It may include integer constants, character constants, floating-point constants, enumeration constants, type casts to integral and floating-point types, and other constant expressions. It cannot include a variable or function call.

**conventional memory** The first 640K (or sometimes 1MB) of memory under MS-DOS. Also called low memory.

**coprocessor** See “8087 family of math processors.”

**.CPP** An extension for a C++ source file.

**CPU (central processing unit)** The main processor in a computer. For example, the CPU that receives and carries out instructions in the PC/AT is an 80286 processor. See also “8086 family of processors.”

**CS:IP** The address of the current program location. This is the address of the next instruction to be executed. CS is the value of the Code Segment register, and IP is the value of the Instruction Pointer register.

**cursor** The thin blinking line or other character that represents the location of typed input or mouse activity.

**.CXX** An extension for a C++ source file.

## D

**.DAT** The extension that is often used to indicate a data file.

**data symbol** The address of a global or static data object. The concept of data symbol includes all data objects except local (stack-allocated) or dynamically allocated data.

**.DBG** The extension for a file that is created by LINK when the /CO and /TINY options are used. The file contains symbolic debugging information.

**debugger** A program that allows the programmer to execute a program one line or instruction at a time. The debugger displays the contents of registers and memory to help locate the source of problems in the program. An example is the Microsoft CodeView debugger.

**debugging information** Symbolic information used by a debugger, especially information in the Microsoft Symbolic Debugging Information format that is used by the Microsoft CodeView debugger.

**.DEF** The extension for a module-definition file.

**default data segment** See “DGROUP.”

**default library** A standard library that contains routines and data for a language. The language’s compiler embeds the name of the default library in the object file in a COMMENT record. The

embedded name tells LINK to search the default library automatically.

**DGROUP** The group that contains the segments called \_DATA (initialized data), CONST (constant data), \_BSS (uninitialized data), and STACK (the program’s stack). Also called default (or automatic) data segment.

**dialog box** A box that appears when you choose a command that requires additional information.

**disassemble** To translate binary machine code into the equivalent assembly-language representation. Also called unassemble.

**disassembly** The assembly-language representation of machine code, obtained by disassembling the machine code.

**.DLL** The extension for a dynamic-link library.

**DLL** A dynamic-link library.

**.DOC** The extension that is often used to indicate a document file.

**DOS application** A program that runs only with MS-DOS. An MS-DOS executable file contains a header and one contiguous block of segments.

**DOS-extended** An application that is able to be run by the DOS Extender in extended or expanded memory.

**DOS Extender** A program that lets an application run in extended or expanded memory.

**DOS session** Under the Windows operating system, a full-screen emulation of the MS-DOS environment started using the MS-DOS Prompt in the Program Manager Main Group. The MS-DOS Prompt program item starts a copy of the MS-DOS command interpreter (COMMAND.COM).

**double precision** A real (floating-point) numeric

value that occupies 8 bytes of memory. Double-precision values are accurate to 15 or 16 digits.

**DPMI (DOS Protected Mode Interface)**

A server that provides extended or expanded memory. An example of a DPMI server is an MS-DOS session in Windows.

**drag** To move the mouse while holding down one of its buttons.

**dump** To display the contents of memory at a specified memory location.

**dynamic link** A method of postponing the resolution of external references until load time or run time. A dynamic link allows the called routines to be created, distributed, and maintained independently of their callers.

**dynamic-link library** A file, usually with a .DLL extension, that contains the binary code for routines and data that are linked to a program at run time.

## E

**EGA (enhanced graphics adapter)**

A video adapter capable of displaying all the modes of the color graphics adapter (CGA) plus additional modes in medium resolution in up to 64 colors.

**EMM386.EXE** An example of a VCPI server. EMM386.EXE simulates expanded memory in extended memory for an 80386 or higher processor.

**EMS** Expanded Memory Specification. See “expanded memory.”

**emulator** A floating-point math package that provides software emulation of the operations of a math processor.

**environment strings** A series of user-definable and program-definable strings associated with each

process. The initial values of environment strings are established by a process’s parent.

**environment table** The memory area, defined by the operating system, that stores environment variables and their values.

**environment variable** A string associated with an identifier and stored by the operating system. Environment variables are defined by the SET command. The identifier and the string associated with it can be used by a program.

**.ERR** The extension for a file of error-message text or error output.

**error code** See “exit code.”

**escape sequence** A specific combination of an escape character (often a backslash) followed by a character, keyword, or code. Escape sequences often represent white space, nongraphic characters, or literal delimiters within strings and character constants.

**.EXE** One of the extensions for an executable file, which is a file that can be loaded and executed by the operating system.

**executable file** A program ready to be run by an operating system, usually with one of the extensions .EXE, .COM, or .BAT. When the name of the file is typed at the system prompt, the statements in the file are executed.

**exit code** An integer returned by a program to the operating system or the program’s caller after completion to indicate the success, failure, or status of the program. Also called a return code or error code.

Exit code also refers to the executable code that a compiler places in every program to terminate execution of the program. This code typically closes open files and performs other housekeeping chores. When a program terminates in CodeView, the current line is in the exit code. No source code

is shown since none is available. See also “startup code.”

**expanded memory** Memory above 640K made available to real-mode programs and controlled through paging by an expanded memory manager.

**expanded memory emulator** A device driver that allows extended memory on computers with an 80286 or later processor to behave like expanded memory.

**expanded memory manager (EMM)**  
A device driver for controlling expanded memory.

**explicit allocation** Assignment to a segment at compile time.

**expression** A combination of operands and operators that yields a single value.

**extended ASCII** ASCII codes between 128 and 255. The meanings of extended ASCII codes differ depending on the system.

**extended dictionary** A summary of the definitions contained in all modules of a standard library. LINK uses extended dictionaries to search libraries faster.

**extended memory** Memory above either 640K or 1 megabyte made available to protected-mode programs on computers with an 80286 or later processor. Extended memory is used by the Windows operating system in standard mode or 386 enhanced mode.

**extended memory manager** A device driver for controlling extended memory, for example, HIMEM.SYS for the Windows operating system.

**extender-ready** See “DOS-extended.”

**extension** One, two, or three characters that appear after a period (.) following the base name in a filename. For example, .TXT is the extension of the filename README.TXT. A filename does not

necessarily have an extension. Sometimes the extension is considered to include the preceding period.

**external reference** A routine or data item declared in one module and referenced in another.

## F

**far address** A memory location specified by using a segment (location of a 64K block) and an offset from the beginning of the segment. Far addresses require 4 bytes—2 for the segment and 2 for the offset. Also called a segmented address. See also “address” and “near address.”

**FAT (file allocation table)** The standard file system for MS-DOS.

**fatal error** An error that causes a program to terminate immediately.

**.FD** The extension for a declaration file (a type of include file) in FORTRAN.

**.FI** The extension for an interface file (a type of include file) in FORTRAN.

**file handle** A value returned by the operating system when a file is opened and used by a program to refer to the file when communicating to the system. Under MS-DOS, COMMAND.COM opens the first five file handles as **stdin**, **stdout**, **stderr**, **stdaux**, and **stdprn**.

**filename** A string of characters identifying a file on disk, composed of a base name optionally followed by a period (.) and an extension. A filename may be preceded by a path. For example, in the filename README.TXT, .TXT is the extension and README is the base name.

**fixup** The linking process that resolves a reference to a relocatable or external address.

**flags register** A register that contains individual bits, each of which signals a condition that can be



tested by a machine-level instruction. In other registers, the contents of the register are considered as a whole, while in the flags register only the individual bits have meaning. In CodeView, the current values of the most commonly used bits of the flags register are shown at the bottom of the Register window.

**flat memory model** A nonsegmented memory model that can address up to 4 gigabytes of memory.

**flipping** A screen-exchange method that uses the video pages of the CGA or EGA to store both the debugging and output screens. When you request the other screen, the two video pages are exchanged. See also “screen exchange” and “swapping.”

**.FOR** The extension for a FORTRAN source file.

**formal parameter** See “parameter.”

**frame** The segment, group, or segment register that specifies the segment part of an address.

**full-screen application** A program that runs with Windows but cannot run in a window.

**function** A routine that returns a value.

**function call** An expression that invokes a function and passes arguments (if any) to the function.

## G

**gigabyte (GB)** 1024 megabytes or 1,073,741,824 bytes (2 to the power of 30).

**global symbol** A symbol that is available throughout the entire program. In CodeView, function names are always global symbols. See also “local symbol.”

**grandparent process** The parent of a process that created a process.

**group** A collection of segments having the same segment base address.

## H

**.H** The extension for an include (or header) file in C.

**HELFILES** The environment variable used by a program to find .HLP files.

**hexadecimal** The base-16 numbering system whose digits are 0 through F. The letters A through F represent the decimal numbers 10 through 15. Hexadecimal is easily converted to and from binary, the base-2 numbering system the computer itself uses.

**highlight** To select an area in a text box, window, or menu as a command or as text to be deleted or copied. A highlight is shown in reverse-video or a bright color.

**high memory** Memory between the 640K of conventional memory and the 1MB limit of a PC’s address space.

**HIMEM.SYS** An example of an XMS server. HIMEM.SYS manages extended memory for an 80286 or higher processor.

**.HLP** The extension for a help file created by HELPMMAKE.

### HPFS (high-performance file system)

An installable file system that uses disk caching and that allows filenames to be longer and to contain certain nonalphanumeric characters.

**huge memory model** A program with multiple code and data segments, and data items that can exceed 64K.

## I

**identifier** A name that identifies a register or a location in memory and usually represents a

program element such as a constant, variable, type, or routine. The terms identifier and symbol are used synonymously in most documentation.

### IEEE format (Institute for Electrical and Electronic Engineers)

A standard for representing floating-point numbers, performing math with them, and handling underflow/overflow conditions. The 8087 family of math processors and the Microsoft emulator library implement this format.

**import library** A library, created by IMPLIB, that contains entry points in DLLs. It does not contain the actual code for routines and data. An import library is used to resolve references at link time in the same way as a standard library; each is a type of static library. See “dynamic-link library” and “standard library.”

**.INC** The extension for an include file in Microsoft Macro Assembler.

**include file** A file that is merged into a program’s source code with a file-inclusion command. In C, this command is the **#include** preprocessor directive. In FORTRAN, it is the **INCLUDE** keyword or the **\$INCLUDE** metacommand. In Microsoft Macro Assembler, the equivalent command is the **INCLUDE** directive. In a .DEF file, the **INCLUDE** statement performs this action. In an NMAKE makefile, it is the **!INCLUDE** directive.

**.INI** The extension for an initialization file.

**INIT** The environment variable usually used by a program to find an initialization file.

**installable file system** A file system that exists in addition to the FAT file system.

**integer** In CodeView and the C language, a whole number represented as a 16-bit two’s complement binary number that has a range from  $-32,768$  through  $+32,767$ . See also “long integer.”

**interoverlay call** A call from a function in one overlay to a function in another overlay, represented internally by an entry in a thunk table.

**interrupt call** A machine-level procedure that can be called to execute a BIOS, DOS, or other function. You can trace into BIOS interrupt-service routines with CodeView, but not into the DOS interrupt (0x21).

**I/O privilege mechanism** A facility that allows a process to ask a device driver for direct access to the device’s I/O ports and any dedicated or mapped memory locations it has. The I/O privilege mechanism can be used directly by an application or indirectly by a dynamic-link library.

## K

**kilobyte (K)** 1024 bytes (2 to the power of 10).

## L

**label** An identifier representing an address.

**large memory model** A program with multiple code and data segments.

**LIB** The environment variable used by LINK to find default libraries.

**.LIB** The extension for a static library.

**library** A collection of routines or data made available to one or more programs through static or dynamic linking.

**LIM EMS** Lotus/Intel/Microsoft Expanded Memory Specification.

**LINK** The environment variable used by LINK for command-line options.

**linking** The process in which the linker resolves all external references by searching the run-time and user libraries and then computes absolute

offset addresses for these references. The linking process results in a single executable file.

**list file** A text file of information produced by a utility such as LIB. See “map file.”

**listing** A generic term for a map, list, or cross-reference file.

**.LNK** The extension that is often used to indicate a response file.

**load library** A static library specified to the linker as an object file, causing all modules in the library to be linked into the program. See “static library.”

**local symbol** An identifier that is visible only within a particular routine. See “global symbol.”

**Local window** The CodeView window in which the local variables for the current routine are displayed.

**logical segment** A segment defined in an object module. Each physical segment other than DGROUP contains exactly one logical segment, except when you use the **GROUP** directive in a Microsoft Macro Assembler module. (Linking with the /PACKC option can also create more than one logical segment per physical segment.)

**long integer** In CodeView and the C language, a whole number represented by a 32-bit two’s complement value. Long integers have a range of -2,147,483,648 to +2,147,483,647. See “integer.”

**low memory** See “conventional memory.”

**.LRF** The extension that is often used to indicate a response file. PWB creates response files with the .LRF extension.

**.LST** The extension that is often used to indicate a list file.

**l-value** An expression (such as a variable name) that refers to a single memory location and is

required as the left operand of an assignment operation or the single operand of a unary operator. For example, X1 is an l-value, but  $X1+X2$  is not.

## M

**machine code** A series of binary numbers that a processor executes as program instructions. See also “disassemble.”

**macro** A block of text or instructions that has been assigned an identifier. For example, you can create a macro that contains a set of functions that you perform repeatedly and assign the macro to a single keystroke.

**.MAK** The extension that is often used to indicate a makefile or description file.

**.MAP** The extension for a map file.

**map file** A text file of information produced by a utility such as LINK. Also called a list file or listing.

**math coprocessor** See “8087 family of math processors.”

**MB** Megabyte.

**MDI** Multiple Document Interface.

**medium memory model** A program with multiple code segments and one data segment.

**megabyte (MB)** 1024 kilobytes or 1,048,576 bytes (2 to the power of 20).

**memory model** A convention for specifying the number of code and data segments in a program. Memory models include tiny, small, medium, compact, large, huge, and flat.

**memory-resident program** See “terminate-and-stay-resident.”

**menu bar** The bar at the top of a display containing menus.

**Mixed mode** The CodeView source display mode that shows each source line of the program being debugged, followed by a disassembly of the machine code generated for that source line. This mode combines Source mode and Assembly mode.

**modification time** See “time stamp.”

**module** A discrete group of statements. Every program has at least one module (the main module). In most cases, each module corresponds to one source file.

**module (in LIB)** See “object module.”

**module-definition file** A text file, usually with a .DEF extension, that describes characteristics of a program. A module-definition file is used by LINK and by IMPLIB.

**monochrome adapter** A video adapter capable of displaying only in medium resolution in one color. Most monochrome adapters display text only; individual graphics pixels cannot be displayed.

**mouse pointer** The reverse-video or colored square that moves to indicate the current position of the mouse. The mouse pointer appears only if a mouse is installed.

**MS32EM87.DLL** A DLL required by the DOS Extender. The SYSTEM environment variable must be set to the directory that contains this file.

**MS32KRNL.DLL** A DLL required by the DOS Extender. The SYSTEM environment variable must be set to the directory that contains this file.

**multitasking operating system** An operating system in which two or more programs or threads can execute simultaneously.

## N

**NAN** An acronym for “not a number.” The math processors generate NANs when the result of an operation cannot be represented in IEEE format.

**near address** A memory location specified by only the offset from the start of the segment. A near address requires only two bytes. See also “address” and “far address.”

**newline character** The character used to mark the end of a line in a text file, or the escape sequence (\n in C language) used to represent this character.

**null character** The ASCII character whose value is 0, or the escape sequence (\0 in C language) used to represent this character.

**null pointer** A pointer to nothing, expressed as the integer value 0.

## O

**.OBJ** The extension for an object file produced by a compiler or assembler.

**object file** A file produced by compiling or assembling source code, containing relocatable machine code.

**object module** A group of routines and data items stored in a standard library, originating from an object file. See also “standard library.”

**object module format** The specification for the structure of object files. Microsoft languages conform to the Microsoft Relocatable Object-Module Format (OMF), which is based on the Intel 8086 OMF.

**offset** The number of bytes from the beginning of a segment or other address to a particular byte.

**OMF** Object module format.

**Output screen** The CodeView screen that contains program output. To switch to this screen, choose the Output command from the View menu or press F4.

**overlay** A program component loaded into memory only when needed.

## P

**packaged function** A function that exists in an object file as a COMDAT record. Packaged functions allow function-level linking. Functions that are not packaged can be linked only at the object level.

**parameter** A data item expected by a routine or information expected in the command line for a utility. Also called a formal parameter. See also “argument.”

**parent process** A process that creates another process, called the child process.

**.PAS** The extension for a Pascal source file.

**path** A specification of the location of a file or a directory. A path consists of one or more directory names and may include a drive (or device) specification. For example, C:\PROJECTPROJLIBS is the path to a subdirectory called PROJLIBS in a directory called PROJECT that is located on the C drive. Sometimes “path” refers to multiple path specifications, each separated by a semicolon (;). In certain circumstances, a path specification must include a trailing backslash; for example, specify C:\PROJECTPROJLIBS\ to tell LINK the location of the PROJLIBS directory containing additional libraries.

**.PCH** The extension for a precompiled C header (or include) file.

**physical segment** A segment listed in the executable file’s segment table. Each physical segment has a distinct segment address, whereas

logical segments may share a segment address. A physical segment usually contains one logical segment, but it can contain more.

### PID (process identification number)

A unique code that the operating system assigns to a process when the process is created. The PID may be any value except 0.

**pointer** A variable containing an address or offset.

**pop-up menu** A menu that appears when you click the menu title with the mouse or press the ALT key and the first letter of the menu at the same time.

**port** The electrical connection through which the computer sends and receives data to and from devices or other computers.

**precedence** The relative position of an operator in the hierarchy that determines the order in which expressions are evaluated.

**privileged mode** A special execution mode (also known as ring 0) supported by the 80286–80486 hardware. Code executing in this mode can execute restricted instructions that are used to manipulate system structures and tables. Device drivers run in this mode.

**procedure** A routine that does not return a value.

**procedure call** A call to a routine that performs a specific action.

**process** Generally, any executing program or code unit. This term implies that the program or unit is one of a group of processes executing independently.

**processor** See “CPU (central processing unit).”

**program step** To trace the next source line in Source mode or the next instruction in Mixed mode or Assembly mode. If the source line or instruction contains a function, procedure, or interrupt call, the call is executed to the end and the CodeView

debugger is ready to execute the instruction after the call. See also “trace.”

**protected mode** The operating mode of the 80286–80486 processors that allows the operating system to protect one application from another.

**protected mode (in Windows)** Either of two modes in the Windows operating system version 3.0: standard mode or 386 enhanced mode. See also “standard mode” and “386 enhanced mode.”

## Q

**.QLB** The extension for a Quick library.

## R

**radix** The base of a number system. In CodeView, numbers can be entered in three radices: 8 (octal), 10 (decimal), or 16 (hexadecimal). The default radix is 10.

**RAM** Random access memory. Usually refers to conventional memory.

**.RC** The extension for a resource script file. An .RC file defines resources for an application such as icons, cursors, menus, and dialog boxes. The Microsoft Windows Resource Compiler compiles an .RC file to create an .RES file.

**real mode** The operating mode of the 80286–80486 processors that runs programs designed for the 8086/8088 processor. All programs for MS-DOS run in real mode.

**real mode (in the Windows operating system)** An operating mode that provides compatibility with versions of Windows-based applications prior to 3.0. Real mode is the only mode of the Windows operating system version 3.0 available for computers with less than 1 megabyte of extended memory.

**redirection** The process of causing a command or program to take its input from a file or device other

than the keyboard (standard input), or causing the output of a command or program to be sent to a file or device other than the display (standard output). The operating-system redirection symbols are the greater-than (>) and less-than (<) signs.

The same symbols are used in the CodeView Command window to redirect input and output of the debugging session. In addition, the equal sign (=) can be used to redirect both input and output.

**Register window** The CodeView window in which the CPU registers and the bits of the flags register are displayed.

**registers** Memory locations in the processor that temporarily store data, addresses, and logical values. See also “flags register.”

**regular expression** A text expression that specifies a pattern of text to be matched (as opposed to matching specific characters). CodeView supports a subset of the regular-expression characters used in the XENIX and UNIX operating systems. PWB supports both the full UNIX syntax and an extended Microsoft syntax for regular expressions.

**relocatable** Not having an absolute address.

**.RES** The extension for a file produced by the Microsoft Windows Resource Compiler from an .RC file.

**response file** A text file containing input expected by utilities such as LINK and LIB. Commonly used extensions for response files include .LRF, .LNK, and .RSP.

**return code** See “exit code.”

**ROM** Read-only memory.

**root** In an overlaid MS-DOS program, the part of the program that always remains in memory. Also called the root overlay.

**routine** A generic term for a procedure, function, or subroutine.

**.RSP** The extension that is often used to indicate a response file.

**RTF** Rich text format.

**run-time error** A math or logic error that occurs during execution of a program. A run-time error often results in termination of the program.

## S

**.SBR** The extension for a file used by BSCMAKE to create a .BSC file.

**scope** The parts of a program in which a given symbol has meaning. The scope of an item may be limited to the file, function, block, or function prototype in which it appears.

**screen exchange** The method by which both the output screen and the debugging screen are kept in memory so that both can be updated simultaneously and either can be viewed at the user's convenience. The two screen-exchange modes are flipping and swapping. See also "flipping" and "swapping."

**scroll** To move text up, down, left, and right in order to see parts that cannot fit on the screen.

**segment** A section of memory containing code or data, limited to 64K for 16-bit segments or 4 gigabytes for 32-bit segments. Also refers to the starting address of that memory area.

**segmented-executable file** The executable file format of a Windows-based application or DLL. A segmented-executable file contains an MS-DOS header, a new .EXE header, and multiple relocatable segments.

**semaphore** A software flag or signal used to

coordinate the activities of two or more threads. A semaphore is commonly used to protect a critical section.

**shell** To gain access to the operating-system command line without actually leaving the PWB or CodeView environment or losing the current context. You can execute operating-system commands and then return to the environment.

**single precision** A real (floating-point) value that occupies 4 bytes of memory. Single-precision values are accurate to six or seven decimal places.

**small memory model** A program with one code segment and one data segment.

**SMARTDRV.EXE** A driver that creates a disk cache in extended or expanded memory.

**source file** A text file containing the high-level description that defines a program.

**Source mode** The mode in which CodeView displays the source code that corresponds to the machine code being executed.

**stack** A dynamically expanding and shrinking area of memory in which data items are stored in consecutive order and removed on a last-in, first-out basis. The stack is most commonly used to store information for function and procedure calls and for local variables.

**stack frame** A portion of a program's stack that contains a routine's local and temporary variables, arguments, and control information.

**stack trace** A symbolic representation of the functions that have been executed to reach the current instruction address. As a function is executed, the function address and any function arguments are pushed on the stack. A trace of the stack shows the currently active functions and the values of their arguments. See also "stack frame."

**standard error** The device to which a program sends error messages. COMMAND.COM opens standard error with a file handle named **stderr**. The default device is the display (CON). Standard error cannot be redirected.

**standard input** The device from which a program reads input. COMMAND.COM opens standard input with a file handle named **stdin**. The default device is the keyboard (CON). Standard input can be redirected using a redirection symbol (<).

**standard library** A library created by LIB that contains compiled routines and data. It is used to resolve references at link time.

**standard mode** The normal Windows version 3.0 operating mode that runs on the 80286–80486 processors. This and 386 enhanced mode are both referred to as protected mode in the Windows operating system and offer more capability than real mode.

**standard output** The device to which a program sends output. COMMAND.COM opens standard output with a file handle named **stdout**. The default device is the display (CON). Standard output can be redirected using a redirection symbol.

**startup code** The code placed at the beginning of a program to control execution of the program code. When CodeView is loaded, the first source line executed runs the entire startup code. If you switch to Assembly mode before executing any code, you can trace through the startup code. See also “exit code.”

**static library** A library used for resolving references at link time. A static library can be either a standard library or an import library. See also “standard library” and “import library.”

**static linking** The combining of multiple object and library files into a single executable file with all external references resolved at link time.

**status bar** The bar at the bottom of the CodeView

or PWB display containing status information and command buttons or a short description of the dialog or menu item currently displayed.

**stderr** See “standard error.”

**stdin** See “standard input.”

**stdout** See “standard output.”

**string** A contiguous sequence of characters, often identified by a symbolic name as a constant or variable.

**structure** A set of elements which may be of different types, grouped under a single name. See also “user-defined type.”

**structure member** One of the elements of a structure.

**stub file** An MS-DOS executable file added to the beginning of a segmented executable file. The stub is invoked if the file is executed with MS-DOS.

**subroutine** A unit of FORTRAN code terminated by the **RETURN** statement. Program control is transferred to a subroutine with a **CALL** statement.

**swapping** A screen-exchange method that uses buffers to store the CodeView display and program output screens. When you request the other screen, the two buffers are exchanged. See also “flipping” and “screen exchange.”

**symbol** See “identifier.”

**symbolic debugging information** See “debugging information.”

**.SYS** The extension for a system file or device driver.

**SYSTEM** An environment variable used by the DOS Extender to find the files MS32EM87.DLL and MS32KRNL.DLL.



**T**

**TEMP** The environment variable usually used by a program to find the directory in which to create temporary files. Other programs use the TMP variable in a similar way.

**temporary file** A file that is created for use by a command while it is running. The file is usually deleted when the command is completed. Most programs create temporary files in the directory indicated by the TMP or TEMP environment variable.

**terminate-and-stay-resident (TSR)**

An MS-DOS program that remains in memory and is ready to respond to an interrupt.

**ternary operator** An operator that takes three operands. For example, the C-language ? operator.

**text file** A file containing only ASCII characters in the range of 1 to 127.

**thread** An operating-system mechanism that allows more than one path of execution through the same instance of a program.

**thread ID** The name or handle of a particular thread within a process.

**thread of execution** The sequence of instructions executed by the CPU in a single logical stream. In MS-DOS, there is only one thread of execution.

**thunk** An interoverlay call in an overlaid MS-DOS program.

**time stamp** The time of the last write operation to the file. Sometimes the term time stamp refers to the combination of the date and time of the last write operation. Also called modification time.

**tiny memory model** A program with a single segment holding both code and data, limited to 64K, with the extension .COM.

**TMP** The environment variable usually used by a

program to find the directory in which to create temporary files. Other programs use the TEMP variable in a similar way.

**.TMP** The extension that is often used to indicate a temporary file.

**toggle** A feature with two states. Often used to describe a command that turns a feature on if it is off, and off if it is on. When used as a verb, “toggle” means to reverse the state of a feature.

**TOOLS.INI** A file that contains initialization information for Microsoft tools such as PWB, CodeView, and NMAKE.

**trace** To execute a single line or instruction. The next source line is traced in Source mode and the next instruction is traced in Assembly mode. If the source line or instruction contains a function, procedure, or interrupt call, the first source line or instruction of the call is executed. CodeView is ready to execute the next instruction inside the call. See also “program step.”

**tracepoint** (obsolete) A breakpoint that is taken when an expression, variable, or range of memory changes. This is now a type of conditional breakpoint. See also “conditional breakpoint.”

**TSR** See “terminate-and-stay-resident.”

**.TXT** The extension for a text file.

**type cast** An operation in which a value of one type is converted to a value of a different type.

**type casting** Including a type specifier in parentheses in front of an expression to indicate the type of the expression’s value.

**U**

**unary operator** An operator that takes a single operand.

**unassemble** To translate binary machine code into

the equivalent assembly-language representation. Also called disassemble.

**unresolved external** A reference to a global or external variable or function that cannot be found either in the modules being linked or in the libraries linked with those modules. An unresolved reference causes a fatal link error.

**user-defined type** A data type defined by the user. See also “structure.”

## V

**variable** A value that may change during program execution.

**VCPI** Virtual Control Program Interface

**VCPI server** A server that provides expanded memory. An example of a VCPI server is Microsoft’s EMM386.EXE.

**VGA (video graphics adapter)** A video adapter capable of displaying both text and graphics at medium to high resolution in up to 256 colors.

**virtual memory** A memory management system that provides more memory to a program than is actually in the system. Virtual memory can consist of a file on disk, extended memory, or expanded memory.

## W

**watchpoint** (obsolete) A breakpoint that is taken when an expression becomes true (nonzero). This is now a type of conditional breakpoint. See also “conditional breakpoint.”

**wildcard** A character that represents one or more matching characters. MS-DOS wildcards (\* and ?) in a filename specification are expanded by COMMAND.COM.

**Windows-based application** A program that runs only with the Windows operating system.

## X

**XMS** Extended Memory Standard (or Specification). See “extended memory.”

**XMS server** A server that provides extended memory. An example of an XMS server is Microsoft’s HIMEM.SYS.

# Index

- ! (exclamation point)
  - HELPMAKE command 602
  - makefile syntax 544, 572
  - replacing text, PWB 86
  - Shell Escape command, CodeView 399, 443–445
- ! command, CodeView 398, 443–445
- " (double quotation marks)
  - .DEF file syntax 494
  - LINK syntax 461
  - makefile syntax 537, 553
- " (quotation marks)
  - character strings 859
  - CodeView syntax 312–313
  - Pause command, CodeView 400, 445
- # (number sign)
  - custom builds 53
  - HELPMAKE syntax 596–597
  - makefile syntax 536, 551–552, 564
  - Tab Set command, CodeView 400, 445
  - TOOLS.INI syntax 534
- \$ (dollar sign)
  - end of line, regular expression syntax 845, 847, 849, 854
  - makefile syntax 536, 552, 554–556, 560, 562
  - reference to tagged expression 848, 855
- \$ macros (NMAKE) 555
- % (percent sign)
  - Filename-Parts Syntax, PWB 247
  - makefile syntax 536
- & (ampersand)
  - C address operator 391–392
  - CodeView 381
  - line continuation character, LIB 586
- ' (single quotation marks), LINK syntax 461
- ( ) (parentheses)
  - balancing, PWB 180–181
  - makefile syntax 554, 556, 560
- (brackets), character class 849, 854
- \* (asterisk)
  - Comment command, CodeView 400, 446
  - Copy command, LIB 589
  - deleting watch expressions, CodeView 437
  - hyperlink, Microsoft Advisor 672
  - makefile syntax 555–556
  - match character, regular expression syntax 847
  - regular expressions, PWB 85
  - wildcard operator
    - HELPMAKE syntax 595
    - UNDEL syntax 655
- \* (asterisk) (*continued*)
  - wildcards 536
- + (plus sign)
  - concatenating help files 680
  - LIB syntax 587–588
  - LINK syntax 461, 463, 469–470
  - searching, PWB 84
- , (comma)
  - argument separator, CodeView 326–327
  - CodeView operator 381
  - LIB syntax 582–583
  - LINK syntax 460, 470
  - with context operator, CodeView 397–398
- (dash)
  - character classes, PWB 84
  - character ranges, regular expression syntax 845
  - HELPMAKE options 595
  - LIB syntax 584, 588
  - LINK syntax 471
  - makefile syntax 544, 572
  - NMAKE syntax 529–532
- \* , LIB syntax 589
- + , LIB syntax 589
- . (period)
  - Current Location command, CodeView 400, 446
  - line number specifier, CodeView 339
  - LINK syntax 461, 466, 469
  - makefile syntax 564, 570
  - match character 844
  - wildcard character 845, 847–848, 850
- ... (ellipsis)
  - call tree, PWB 92
  - menu commands, PWB 72, 74, 116
- / (forward slash), LIB syntax 584
- / (slash)
  - EXEHDR syntax 514
  - HELPMAKE options 595
  - LINK syntax 463, 471
  - makefile syntax 535, 538, 543, 551–552
  - NMAKE syntax 529
  - Search command, CodeView 335, 336, 400, 447–48
- /? option
  - BSCMAKE 621
  - CVPACK 633
  - EXEHDR 515
  - EXP 656
  - HELPMAKE 599
  - IMPLIB 654
  - LIB 586

- /? option (continued)*
    - LINK 488
    - NMAKE 532
    - RM 655
    - SBRPACK 625
    - UNDEL 656
  - /2 option, CodeView* 310
  - /25 option, CodeView* 310–311
  - /43 option, CodeView* 310–311
  - /50 option, CodeView* 311
  - /8 option, CodeView* 310
  - :* (colon)
    - CodeView operator 381
    - .DEF file syntax 494
    - Delay command, CodeView 400, 450
    - HELPMAKE commands 605
    - LINK syntax 471
    - makefile syntax 538–542, 560, 564, 570
  - ::* (scope operator), CodeView precedence 382
  - >* (base operator), CodeView precedence 382
  - >* command, HELPMAKE 607
  - ;* (semicolon)
    - comments, PWB 126–127
    - .DEF file syntax 494
    - LIB syntax 582–584
    - LINK syntax 461, 467–470
    - makefile syntax 542, 544, 564
    - TOOLS.INI syntax 534
  - <* (less than operator), Redirect Input command, CodeView 312–313, 450
  - < >* (angle brackets)
    - command buttons, PWB 72, 74
    - makefile syntax 547–548, 555
  - =* (equal sign)
    - .DEF file syntax 494
    - makefile syntax 551, 560
    - Redirect Input and Output command, CodeView 400, 452
  - >* (DOS redirection symbol), HELPMAKE syntax 597
  - >* (greater than operator), Redirect Output command, CodeView 312–313, 400, 450–451
  - >>* (help delimiter), HELPMAKE 609–610, 612
  - ?* (question mark)
    - call tree, PWB 91
    - decorated names, C++ 385–386
    - Display Expression command, CodeView 400, 452–453
    - makefile syntax 555–556
    - wildcard operator
      - HELPMAKE syntax 595
      - regular expression syntax 847 854–855
      - UNDEL 655
    - wildcards 536
  - ?:* (conditional operator), CodeView 381
  - ??* command, CodeView 400, 453–454
  - @* (at sign)
    - BSCMAKE syntax 622
    - LIB syntax 583
    - LINK syntax 470
    - local contexts, HELPMAKE 603–604
    - makefile syntax 544–556
    - naming registers, CodeView 377, 395
    - NMAKE syntax 533
    - Redraw command, CodeView 400, 454
  - @* command, CodeView 400, 454
  - [ ]* (brackets)
    - balancing, PWB 180–181
    - call tree, PWB 92
    - character class 845, 847, 849, 854
    - match character 844
  - \* (backslash)
    - escape 847–848, 854
    - HELPMAKE syntax 604–605
    - line continuation character, PWB 105–107, 126
    - match character 847–848, 854
    - regular expressions, PWB 88
    - Screen Exchange command, CodeView 400, 454
  - \\* formatting attribute, HELPMAKE 604–605
  - ^* (caret)
    - character ranges 847
    - makefile syntax 535, 551–552, 561
    - regular expressions syntax
      - line beginning 845, 847, 849, 854
      - match line beginning 847, 849, 854
      - PWB 84, 87
  - \_* (underscore), symbol format, CodeView 385–386
  - 32-Bit Registers command, CodeView 343, 346
  - 386 enhanced mode defined 857
  - 7 command, CodeView 400, 448–449
  - 8086
    - instruction mnemonics, assembling 400–402
    - processors defined 857
  - 8087
    - command, CodeView 347–348, 400, 448–449
    - processors defined 855
    - window, CodeView
      - defined 857
      - function 330
      - opening 348
      - overview 322
  - 8259, interrupt trapping 314
  - 8514 display, specifying, CodeView 311
- ## A
- a, alphanumeric character, predefined expression syntax 846, 848, 853
  - A command, and Restart command, CodeView 412–413

- A command, CodeView 398, 400–402
- \a formatting attribute, HELPMMAKE 602, 604–605
- /A option
  - LINK 472
  - NMAKE 530
- About command
  - CodeView 349–350
  - PWB 70
- /Ac option, HELPMMAKE 596
- Access control, CodeView 386
- Activating windows, PWB 244
- Actual parameters *See* Arguments
- Adapter defined 857
- Add command, LIB 587–588
- Add Watch command, CodeView 338–339, 399
- Add Watch dialog box, CodeView 339
- Add Watch Expression command, CodeView 436
- Adding
  - breakpoints, CodeView 341–342
  - commands, PWB Run menu 115, 117
  - custom sections, PWB 53
  - files, PWB 38–39, 41, 44
  - Program Item, PWB 58
  - watch expressions, CodeView 339, 436
- Address ranges
  - CodeView expressions 379, 396–397
  - defined 857
- ADDRESS, /MAP option 478
- Addresses
  - CodeView expressions 378, 396
  - defined 857
  - variables, debugging assembly code 391
- AH register, CodeView syntax 395, 426
- AHelp, Help files 219–220
- AL register, CodeView syntax 395, 426
- /ALIGN option LINK 472
- /ALIGNMENT option LINK 472
- Aligning tabs, PWB 276
- Alignment, EXEHDR 522
- All Files command, PWB 63
- All Windows command, PWB 69
- alloc\_text pragma 509
- Alphabetic characters, predefined expression syntax 846, 848, 853
- Alphanumeric characters, predefined expression syntax 846, 848, 853
- Alternation, regular expression syntax 846–847, 849, 854
- ALTGR key, enabling 257
- Ampersand (&)
  - C address operator 391–392
  - CodeView 381
  - line continuation character, LIB 586
- Angle brackets (<>)
  - command buttons, PWB 72, 74
  - makefile syntax 547–548, 555
- Animate command, CodeView 336–337, 344, 398, 408, 429
- Anonymous allocation defined 857
- ANSI
  - defined 857
  - escape sequence, CodeView expressions 385
- API defined 857
- Application programming interface defined 855
- Application type
  - determining EXEHDR 523
  - specifying
    - EXEHDR 514
    - NAME statement 495
    - /PM option, LINK 485
  - Windows *See* Windows, programs for
- APPLoader statement 498
- Archives, in libraries, LIB 581
- Arg function, PWB 140, 146–147
  - executing 96–98
  - getting help 670
  - replacing text 86
- argc defined 857
- Arguments
  - CodeView
    - entering 326
    - format 326–327
    - setting 337–338
  - command line 309
  - defined 857
  - functions, PWB 146–147
- argv defined 857
- Arrange command
  - CodeView 347–348
  - PWB 69, 135
- Arrangewindow function, PWB 140, 147
- Arrays
  - debugging assembly language 392
  - defined 858
  - expanding and contracting, CodeView 342, 453–454
- AS macro (NMAKE) 558
- ASCII
  - characters defined 858
  - HELMMAKE format 612
  - memory format, CodeView 331
- Askexit switch, PWB 244, 248
- Askrtm switch, PWB 244, 249
- .ASM files defined 858
- Assemble command
  - and Restart command 412–413
  - CodeView 398, 400–402
- Assembler, changing options, PWB 47, 49–50

Assembling 8086 instruction mnemonics 400–402  
Assembly language, debugging 389–392  
Assembly mode defined 858  
Assign function  
  executing 98  
  key assignment, changing 111  
  PWB 140, 147–149  
  switch settings, changing 114  
Asterisk (\*)  
  Comment command, CodeView 400, 446  
  deleting watch expressions, CodeView 437  
  hyperlink, Microsoft Advisor 672  
  LIB syntax 589  
  makefile syntax 555–556  
  match character 844  
  regular expressions, PWB 85  
  wildcard operator  
    HELPMMAKE syntax 595  
    UNDEL syntax 655  
  wildcards 536  
At sign (@)  
  BSCMAKE syntax 622  
  LIB syntax 583  
  LINK syntax 470  
  local contexts, HELPMMAKE 603–604  
  makefile syntax 544, 555–556  
  naming registers, CodeView 377, 395  
  NMAKE syntax 533  
  Redraw command, CodeView 400, 454  
Attributes  
  formatting, HELPMMAKE 602, 604–605  
  segment *See* Code segments; Data segments;  
    Segments  
Auto option, Language command, CodeView 344  
AUTOEXEC.BAT  
  HELPPFILES environment variable 679  
  PWB configuration 127  
Autoload switch, PWB 244, 249–250  
Automatic data segment *See* DGROUP  
Autosave switch, PWB 112, 244, 250  
Autostart entry, TOOLS.INI file, CodeView 302  
Autostart macro, PWB 210  
Available memory defined 858  
AX register, CodeView syntax 395, 426

## B

\b formatting attribute, HELPMMAKE 603–605  
\b formatting code, HELPMMAKE 610  
B option, CodeView 310  
/B option  
  CodeView 312  
  LINK 472  
  NMAKE 530

b, white space, predefined expression syntax 846, 848,  
853  
Backing up files, PWB 87, 281, 654–656  
Backslash (\)  
  escape, regular expression syntax 847–848, 854  
  HELPMMAKE syntax 604–605  
  line continuation character, PWB 105, 107, 126  
  LINK syntax 463  
  makefile syntax 535, 538, 543, 551–552  
  match character 847–848, 854  
  regular expressions, PWB 88  
  Screen Exchange command, CodeView 400, 454  
Backtab function, PWB 118, 140, 149  
Backup files  
  creating 654–656  
  setting number, in PWB 281  
Backup switch, PWB 244, 251  
.BAK file defined 858  
Banner *See* /NOLOGO option  
.BAS file defined 858  
Base names  
  Curfilenam predefined macro, PWB 211  
  defined 858  
  Shortnames switch, PWB 275  
Base operator (:<), CodeView precedence 382  
\_\_based keyword, explicit allocation 509  
.BAT file defined 858  
Batch files  
  backing up .ASM files, PWB 87  
  building browser database, PWB 94–96  
  defined 858  
/BATCH option, LINK 472  
BC command, CodeView 398, 402–403  
BC macro (NMAKE) 558  
BD command, CodeView 398, 403–404  
BE command, CodeView 398, 404–405  
Beep switch, PWB 244, 251  
Begfile function, PWB 149  
Begline function, PWB 150  
BFLAGS macro (NMAKE) 559  
BH register, CodeView syntax 395, 426  
Binary  
  files defined 858  
  operators defined 858  
BIOS defined 858  
Bit rate, remote debugging 370  
BL command, CodeView 398, 405  
BL register, CodeView 395, 426  
Black color value 254  
Blue color value 254  
.BMP file defined 858  
Bold text, HELPMMAKE formatting  
  QuickHelp 604–605  
  rich text format 610

- Boolean switches, PWB 112, 248
- Box Mode command, PWB 64, 133
- Boxes, command execution, PWB 72
- BP command, CodeView 358–359, 376, 398, 405–408, 420–421
- BP register, CodeView syntax 395, 426
- Braces ( { } )
  - context operator, CodeView 381–384, 397–398
  - key box, PWB 110
  - makefile syntax 542, 565
  - RTF formatting codes 610
- Brackets ( [ ] )
  - balancing, PWB 180–181
  - call tree, PWB 92
  - character class 847, 849, 854
  - match character 844
- Breakpoint Clear command, CodeView 398, 402–403
- Breakpoint Disable command, CodeView 398, 403–404
- Breakpoint Enable command, CodeView 398, 404–405
- Breakpoint List command, CodeView 398, 405
- Breakpoint Set command, CodeView 358–359, 398, 405–408, 420–421
- Breakpoints
  - CodeView
    - clearing 402–403
    - disabling 403–404
    - enabling 404–405
    - listing 405
    - saving 317
    - setting 298, 339–341, 358–359, 405–408
  - defined 858
- Bright Back check box, customizing colors, PWB 115
- Bright Fore check box, customizing colors, PWB 115
- Browcase switch, PWB 286
- Brown color value 254
- Browse Information Compactor *See* SBRPACK
- Browse menu, PWB 68, 134, 187
- BROWSE option, and BSCMAKE, COBOL 616
- Browse Options command, PWB 67
- Browser database
  - See also* BSCMAKE; SBRPACK
  - .BSC file 615, 618
  - builds
    - described 616
    - full 617, 619, 621
    - incremental 617, 619
    - optimizing 617, 624
    - options 620, 622
  - creating .SBR files 616
  - empty .SBR files 617
  - file size 617–618
  - full build 617, 619, 621
  - include files, excluding 620–621, 624
  - incremental build 617, 619
- Browser database (*continued*)
  - information 621
  - local symbols, excluding 616, 620
  - macro expansions, excluding 620
  - naming the .BSC file 621
  - optimizing 617, 624
  - options 620, 622
  - overview 615
  - packing .SBR files 616, 623–624
  - public symbols 616
  - PWBRMAKE.EXE 615
  - removing an .SBR file 617
  - .SBR file 616
  - specifying .BSC file 617
  - symbols
    - excluding 616, 620
    - unreferenced 621, 623
  - tools 615
  - truncated .SBR files 617
  - unreferenced symbols 621, 623
  - updating a database 616
  - verbose output 621
  - zero-length .SBR files 617
- Browser Database Maintenance Utility *See* BSCMAKE
- Browser database, PWB
  - building 52, 92, 94–96
  - creating 89–90
  - estimating file size 94
  - finding symbol definitions 92–93
  - makefiles 55
  - menu commands 68
  - specifying switches 287
- Browser information files, PWB
  - browser database 89–90
  - building browser database, non-PWB 95
  - estimating size 94
- Browser Output command, PWB 69
- Browser Output pseudofile, PWB 93
- Browser, source *See* Source browser
- BSCMAKE
  - See also* Browser database; SBRPACK
  - .BSC file 615, 618
  - building a database 616
  - builds
    - full 617, 619, 621
    - incremental 617, 619
  - command line 619–620
  - copyright message 621
  - creating .SBR files 616
  - empty .SBR files 617
  - environment variable, INCLUDE 620
  - error codes 623
  - exit codes 623
  - full build 617, 619, 621

BSCMAKE (*continued*)

- help 620–621
- INCLUDE environment variable 620
- include files, excluding 620–621, 624
- incremental build 617, 619
- information 621
- local symbols, excluding 620
- macro expansions, excluding 620
- naming .BSC file 617, 621
- operating system 618
- options 620–622
- overview 615, 618
- packing .SBR files 616, 623–624
- PWBRMAKE.EXE 615
- removing an .SBR file 617
- response file 622
- return codes 623
- rules 619
- running 619–620, 622
- running requirements 618
- .SBR file 616
- symbols
  - excluding 620
  - unreferenced 621, 623
- syntax 619, 622
- system requirements 618
- truncated .SBR files 617
- unreferenced symbols 621, 623
- updating a database 616
- verbose output 621
- zero-length .SBR files 617

BSCMAKE command, building browser database

- non-PWB 95
- PWB 89–90

BSCMAKE.EXE 618

.BSC files

- defined 858
- PWB
  - building browser database 89
  - estimating size 94
- use 615, 618

Buffers

- CodeView command window 328
- decompression, specifying size 304
- defined 858

Bugs *See* Debugging

Build command, PWB 66, 134

Build errors in PWB 23

Build Results command, PWB 69

Build Results window, PWB

- clearing 152
- Nextmsg function 177
- PWB 242
- retaining results 268

Build switch, PWB 244

Build:message switch, tagged expressions 852

Building

- browser database, PWB 89–90, 92, 94–96
- canceling, `_pwbcancelbuild` macro 214
- canceling, `_wbcancelbuild` macro 215
- customized PWB projects 52–55
- described, PWB 51–52
- menu commands, PWB 66
- multimodule programs, PWB 40
- projects *See* NMAKE
- `_pwbbuild` macro 214
- targets, PWB 153–154

Buttons

- command execution, PWB 72–74
- hyperlinks
  - index screens 672
  - navigating with 666–668

BX register, CodeView syntax 395, 426

BY operator, CodeView 381, 390–392

Bytes, displaying, CodeView 330–332

**C**

C Compiler Options command, PWB 67

C expression evaluator

- choosing 380
- defined 375
- overview 375
- using 381–384

C function prototypes 648

C header files 634

C option, CodeView 310

C preprocessor keywords recognized by H2INC (list) 652

C preprocessor pragmas recognized H2INC (list) 652

C++ Compiler Options command, PWB 67

C++ expression evaluator

- choosing 380
- overview 375
- using 381–384, 386–392

c, alphabetic character, syntax 846, 848, 853

C, C++ expression evaluator, debugging assembly language programs

- with BY memory operator 389–390
- with DW memory operator 389–390
- with WO memory operator 389–390

C, C++ expression evaluators

- and MASM 389
- symbols, search order 382

:c command, HELPMMAKE 606

\c, escape, regular expression syntax 843, 846

.C files defined 858

/C option

- CodeView 312–313



- /C option (*continued*)
  - HELPMAKE 596
  - NMAKE 530
- /c option, ML, debugging considerations 296
- C, C++ programs, debugging restrictions with CodeView 382
- Call gates defined 858
- Call Tree (Fwd/Rev) command, PWB 68
- Call trees, PWB 78, 91–92
- Calling functions, CodeView expressions 382
- Calls menu, CodeView 346–347
- Cancel function, PWB 140, 150
- Cancelling
  - background search, `_pwbcancelsearch` macro 215–216
  - builds, `_pwbcancelbuild` macro 214–215
  - print operations, `_pwbcancelprint` macro 215
- Cancelsearch function, PWB 141, 151
- Caret (^)
  - character ranges 845
  - line beginning 845, 847, 849, 854
  - makefile syntax 535, 551–552, 561
  - regular expressions, PWB 84, 87
- Cascade command, PWB
  - described 69
  - predefined macros 135
- Cascading window arrangements, `_pwbcascade` macro 216
- Case sensitivity
  - browser database 286
  - CodeView
    - commands 393
    - expression evaluators 382
    - generally 346
    - options 422–424
  - command, CodeView 342, 346
  - .DEF file syntax 494
  - defined 859
  - global searches, in Microsoft Advisor 674
  - /IGN option, LIB 585
  - IMPLIB 653
  - /NOI option
    - LIB 585
    - LINK 480
  - PWB
    - options 131–132
    - search functions 251–252
- Case switch, PWB 244, 251–252
- Case, matching, CodeView search option 335, 336
- CASEMAP:NONE argument, OPTION directive 638
- .category command, HELPMAKE 606
- CC macro (NMAKE) 558
- `_cdecl` keyword, symbol format, CodeView 385–386
- Cdelete function, PWB 140, 151
- CFLAGS macro (NMAKE) 559
- CGA
  - defined 859
  - displays, suppressing snow, CodeView option 314
- CH register, CodeView syntax 395, 426
- Character range, regular expression syntax 847
- Character strings defined 859
- Characters
  - ASCII, defined 856
  - classes,
    - PWB 84
    - regular expression syntax 845, 847, 849, 854
  - control, HELPMAKE 596
  - deleting, PWB 151, 157, 196
  - inserting, PWB 163
  - matching, regular expression syntax 847
  - predefined expression syntax 846, 848
  - searching 83
- Check box, PWB 74
- Checksum, EXEHDR 518, 522
- Child process defined 859
- CL
  - options, debugging considerations 296
  - register CodeView syntax 395, 426
- Class Hierarchy command, PWB
  - described 68
  - function 134
- CLASS keyword, SEGMENTS statement 502
- Class Tree (Fwd/Rev) command, PWB 68
- Class Tree command, PWB 134
- Classes
  - characters, syntax 845, 847, 849, 854
  - CodeView accessibility 386–388
- Clearing breakpoints in CodeView 341–342, 402–403
- Clearmsg function, PWB 140, 152
- Clearsearch function, PWB 140, 152
- Click defined 859
- Clipboard defined 859
- Clipboard Results command, PWB 69
- Close All command, PWB
  - described 69
  - predefined macros 135
- Close command
  - CodeView 347–348
  - PWB 64, 69, 132, 134–135
- Close Project command, PWB 66
- Closefile function, PWB 140, 153
- Closing
  - files, PWB 64, 217–218
  - help files
    - PWB 200
    - QuickHelp 677
  - menus, PWB 71
  - projects, PWB 218

Closing (*continued*)

- windows, PWB 206, 217

- CLRFILE.CV4, CodeView 315–316, 334–345

- CLRFILE.CVW, CodeView 315–316, 334–345

- !CMDSWITCHES directive 534, 572

- /CO option, LINK 296–297, 473, 632

- .COB files defined 859

- COBFLAGS macro (NMAKE) 559

- COBOL macro (NMAKE) 558

## Code

- inline, debugging 294

- links, HELPMMAKE 602

- searching, PWB 77

- segments

  - See also* Segments

  - attributes 501, 503

  - discardable 503

  - loading 504

  - moving 504

  - packing 481–482

  - permissions 503

  - sharing 504

- source, displaying 324, 433–436

- symbols defined 859

- tracing p-code to native code 366–367

- CODE statement 501

- Codes, inserting, HELPMMAKE rich text format 610

- CodeView 437

  - 32-bit register command 346

  - access control 386

  - active window

    - identifying 322

    - selecting 322

  - ambiguous references, qualifying 386

  - and [386 Enh] section of SYSTEM.INI 352

  - and Assembly mode 324

  - and CVPACK 631

  - and environment table 294

  - and library code 324

  - and MASM 389

  - and Microsoft Windows 3.0

    - 386 enhanced mode 353

    - and PIF file 353

    - Real mode 353

    - Standard mode 353

  - and system code 324

  - animating 408

  - arguments

    - entering 326

    - format 326

    - setting 337–338

  - breakpoints

    - clearing 402–403

    - disabling 403–404

CodeView (*continued*)

- breakpoints (*continued*)

  - editing 341–342

  - enabling 404–405

  - listing 405

  - on constructors 387

  - on destructors 387

  - setting 298, 339–341, 358–359, 405–408

- C, C++ program debugging restrictions 382

- case sensitivity

  - commands 346, 393

  - expression evaluators 382

  - options 422–424

- /CO option, LINK 473

- code segment attribute 503

- command line 308–316

- commands

  - copying text 327–328

  - described 436

  - entering 326

  - executing 312–313, 409–410

- compacting files with CVPACK 631–632

- component DLLs, Table of 300

- configuring 301

- contracting elements 342, 453–454

- current radix, overriding 384

- CURRENT.STS, PWB 128

## CVW

- commands 357–360

- compared to CV 351–357

- general protection faults (GPF) 363

- multiple applications 355–357

- multiple instances 354

- restarting halted debugging sessions 363

- running 352–353

- techniques 360–363

- CVW.EXE and CVW1.386 in current path 352

- debugging

  - assembly language 389–392

  - p-code 363–367

  - RND.ASM example 26

- displays

  - black-and-white 312

  - line-display mode 311

  - overview 319–321

  - redrawing 454

  - screen exchange 313, 315, 345, 422–424, 454

  - specifying 310–311

  - suppressing snow 314

- dynamic-link libraries 299–300, 314, 337–338

- editing 334–335

- execution

  - controlling 361

  - speed of 429

CodeView (*continued*)

- execution (*continued*)
  - terminating 362
- exiting 309
- expanding elements 342, 453–454
- expression evaluators
  - and MASM 380
  - choosing 380–381, 430
  - defined 375
  - listing 344
  - numbers 384
  - operators 381–384
  - string literals 385
  - symbol format 385–386
- expressions
  - See also* Expressions
  - address ranges 379, 396–397
  - addresses 378, 396
  - C++ 386–392
  - line numbers 376, 394
  - overview 375
  - registers 377
- first time startup, open windows 322
- flags, changing values 426–428
- functions
  - listing 411–412
  - tracing 428
- GlobalLock function 439
- help
  - See also* Microsoft Advisor
  - getting 664–673
  - structure 663
- Help menu 665
- identifying bugs 297
- installing 299–301
- interrupt trapping 314
- interrupting execution 361
- line-display mode with EGA and VGA 311
- loading symbolic information 314
- locating bugs 298
- memory
  - comparing 413–414
  - dumping 414–415
  - entering data 416–418
  - filling 418–419
  - format 330–332
  - management of 308
  - moving blocks of 419
  - searching 419–420
  - viewing 32, 431–433
- menus
  - Calls menu 346–347
  - Data menu 338–342
  - Edit menu 334–335

CodeView (*continued*)

- menus (*continued*)
  - File menu 332–334
  - Help menu 349
  - Options menu 342–346
  - Run menu 336–338
  - Search menu 335–336
  - Windows menu 347
- modules
  - configuring 337–338
  - listing 439
- mouse, disabling 315
- opening windows 322
- options 310–315, 317, 370–371, 422–424
- packed files 476
- p-code, debugging considerations 367
- preparing programs 293–297
- printing 333
- PWB menu commands 66
- quitting 334
- radix 420–421
- radix, syntax 384
- registers, changing values 426–428
- remote debugging
  - overview 367
  - requirements 368–370
  - starting a session 371–373
  - syntax 370
- restarting 337, 412–413
- searching 335–336
- shell escape 443–445
- slow motion execution 337, 344
- source code, displaying 433–436
- source files
  - loading 333
  - opening 333
- state file
  - overview 316–317
  - tooggling status 315
- stepping through a program 28
- syntax 308–316
  - CVW commands 357–360
  - expressions 376–379, 394–397
  - regular expressions 845
  - TOOLS.INI file entries 302–308
- TOOLS.INI file entries 302–308
- trace speed 429
- variables
  - listing 344
  - local 328–329
  - program 324–325
- viewing output 349
- watch expressions
  - adding 339, 436

- CodeView (*continued*)
  - watch expressions (*continued*)
    - deleting 339, 437
    - listing 441
    - setting 298–299
  - watch window
    - adding expressions 325
    - and multi-level structures 325
    - changing variables 325
    - opening 325
  - windows
    - 8087 window 330
    - Command window 326–328, 393
    - Help window 332
    - Local window 328–329
    - Memory windows 330–332
    - navigation 323
    - opening 347
    - overview 320–322
    - Register window 329–330
    - Source windows 324
    - Watch window 324–325
  - WKA command, and mouse pointer queue blocking 360
- CodeView (CVW)
  - startup position in Microsoft Windows, setting with /X and /Y options 316
  - /X option, when starting CodeView from Microsoft Windows 316
  - /Y option, when starting CodeView from Microsoft Windows 316
- /CODEVIEW option, LINK 473
- CodeView Options command, PWB 67
- CODEVIEW.LST, CodeView, Printfile entry in TOOLS.INI 306
- Colon (:)
  - CodeView operator 381
  - .DEF file syntax 494
  - Delay command, CodeView 400, 450
  - HELPMAKE commands 605
  - LINK syntax 471
  - makefile syntax 538–540, 542, 560, 564, 570
- Color
  - entry, TOOLS.INI file, CodeView 302
  - graphics adapter defined 857
  - switch, PWB 244, 252, 254
- Colors
  - customizing, PWB 114–115
  - setting, CodeView 345
  - specifying, PWB 252, 254, 288
  - values 254
- Colors command
  - CodeView 342, 345
  - PWB 67
- Colors dialog box, CodeView 345
- .COM files, 487, 859
- Combo box, PWB 73–74
- COMDAT record 484, 508
- Comma (,)
  - argument separator, CodeView 326–327
  - CodeView operator 381
  - LIB syntax 582–583
  - LINK syntax 460, 470
  - with context operator, CodeView 397–398
- Command buffer, using CodeView 328
- Command button, PWB 74
- Command command, CodeView 347–348
- .command command, HELPMAKE 606
- Command files
  - See also* Response files
  - defined 859
  - inline, in makefiles 547
  - NMAKE 533–534, 859
- Command lines
  - BSCMAKE 619–620
  - CodeView 308–316
  - CVPACK 632
  - EXEHDR 513–514
  - EXP 656
  - IMPLIB 653
  - LIB 582
  - limit 469
  - LINK 460–466, 468
  - NMAKE 529
  - PWB 131–132
  - RM 654–655
  - SBRPACK 624
  - UNDEL 655–656
- Command shell, DOS Shell command, CodeView 333
- Command window, CodeView
  - function 326–328
  - opening 348
  - overview 321
- Command-line options, H2INC 636
- COMMAND.COM, file handles 860
- Commands
  - CodeView
    - copying text for 327–328
    - CVW 357–360
    - Data menu 338–342
    - Edit menu 334–336
    - entering 326
    - executing 312–313, 409–410
    - File menu 332–334
    - for Windows applications 351
    - format 326–327
    - generally 400–454
    - Help menu 349

- Commands (*continued*)
- CodeView (*continued*)
    - Options menu 342–346
    - Run menu 336–338
    - Windows menu 347
  - defined 859
  - dot commands, HELPMMAKE 597–598, 605–606, 608
  - Help menu, PWB 70
  - library *See* LIB
  - makefile *See* Makefiles; NMAKE
  - PWB
    - choosing 70–71
    - cursor movement 144
    - Edit menu 64–66
    - executing 70, –74, 132, 160, 205
    - File menu 64
    - Options menu 67
    - predefined 132–135
    - Project menu 66
    - Run menu 66
    - Run menu, adding 115, 117
    - Search menu 65
    - Window menu 69
  - QuickHelp 678
  - .comment command, HELPMMAKE 606
  - Comment command, CodeView 400, 446
  - Comment line, custom builds in PWB 53
  - Comments
    - .DEF files 494
    - DESCRIPTION statement 497
    - macros (NMAKE) 551
    - makefiles 536
    - pragma 465
    - TOOLS.INI file 126–127, 301, 534
  - Compact memory model defined 859
  - Compacting files, CVPACK 631–632
  - Compile command, PWB, predefined macros 134
  - Compile File command, PWB 66
  - Compile function, PWB 140, 153–154
  - Compiler options, debugging considerations 295–296
  - Compilers, menu commands, PWB 67
  - Compiling
    - debugging considerations 295
    - defined 859
    - files, PWB 218–219
  - Compressing
    - help database 595–596
    - keywords, HELPMMAKE option 596–597
  - Concatenating help files 680
  - Conditional breakpoints defined 859
  - Conditional operator (?), CodeView 381
  - CONFIG.SYS
    - editing, PWB 58
    - memory management, CodeView 308
  - CONFIG.SYS (*continued*)
    - PWB configuration 127
  - Configuring CodeView
    - modules 337–338
    - TOOLS.INI 301
  - Consistency check, LIB 584
  - Constant expressions defined 859
  - Constants defined 859
  - Constructors, using C++ expressions 387–388
  - Contents command
    - CodeView 349
    - PWB 70, 135, 665
  - Context
    - operator ({}), CodeView 381
    - operator ({}), CodeView 382–384, 397–398
    - prefixes, HELPMMAKE 613
  - .context command, HELPMMAKE 600–609
  - contextstring command, HELPMMAKE 602–603
  - Contracting elements in CodeView 342, 453–454
  - Control characters, specifying, HELPMMAKE 596
  - Conventional memory
    - browser database 617–618, 621
    - defined 859
  - Conversion functions using C++ expressions 387–388
  - Coprocessors
    - defined 859
    - displaying registers, CodeView 330
  - Copy command
    - CodeView 335
    - LIB 589
    - PWB 64, 133
  - COPY command, MS-DOS
    - concatenating help databases 594–595
    - concatenating help files 680
  - Copy function, PWB 141, 154–155
  - Copying
    - files, PWB 87
    - text
      - CodeView commands 327–328
      - Microsoft Advisor 668
      - QuickHelp 679
  - Copyright message *See* /NOLOGO option
  - /CP option, LINK 473
  - /CPARM option, LINK 473
  - /CPARMAXALLOC option, LINK 473
  - .CPP file defined 859
  - CPP macro (NMAKE) 559
  - CPPFLAGS macro (NMAKE) 559
  - CPU defined 859
  - Creating
    - backup files 654–656
    - browser database, PWB 89–90
    - call tree, PWB 91–92
    - import libraries, IMPLIB 652–653

Creating (*continued*)  
 pseudofiles, in PWB 175–176, 227–228  
 Cross-reference listing, LIB 590  
 CS command, CodeView 399  
 CS register, CodeView syntax 395, 426  
 CS:IP  
   defined 860  
   saving, CodeView 317  
 Curdate function, PWB 141, 155  
 Curday function, PWB 141, 155  
 Curfile predefined macro, PWB 207–210  
 Curfilext predefined macro, PWB 207, 208, 211  
 Curfilenam predefined macro, PWB 207, 208, 211  
 Current date, PWB 155  
 Current Location command, CodeView 400, 446  
 CURRENT.STS  
   CodeView  
     overview 316–317  
     saving 334  
     togglng status of 315  
   PWB 128  
 Cursor  
   defined 860  
   PWB commands 144–146  
   shape of, in PWB 254  
 Cursormode switch, PWB 244, 254  
 Curtime function, PWB 141, 156  
 Customize Project Template command, PWB 67  
 Customize Run Menu command, PWB 66  
 Cut command, PWB 64, 133  
 CV *See* CodeView  
 Cvdllpath entry TOOLS.INI file, CodeView 302–303  
 CVPACK  
   and CodeView 631  
   and LINK 457  
   command line 632  
   exit codes 633  
   help 633  
   options 633  
   overview 631–632  
   syntax 632  
 CVW  
   *See also* CodeView  
   commands 357–360  
   compared to CV 351  
   debugging techniques 360–363  
   general protection faults (GPF), handling 363  
   multiple applications, debugging 354–357  
   running 352, 353  
 CX register, CodeView syntax 395, 426  
 .CXX files defined 860  
 CXX macro (NMAKE) 559  
 CXXFLAGS macro (NMAKE) 559  
 Cyan color value 254

**D**

d., context prefix, HELPMAKE 613–614i  
 \d: (digit) predefined expression syntax 846, 848, 853  
 /D option  
   CL 405–408  
   HELPMAKE 598  
   NMAKE 530  
   PWB 131  
 /DA option, PWB 131  
 Dark Gray color value 254  
 Dash (-)  
   character classes, PWB 84  
   character ranges, syntax 845  
   HELPMAKE options 595  
   LIB syntax 584, 588  
   LINK syntax 471  
   makefile syntax 544, 572  
   NMAKE syntax 529–530, 532  
 .DAT files defined 860  
 Data  
   dumping, CodeView 414–415  
   entering, CodeView 416–418  
   importing, module-definition files 507  
   moving blocks, CodeView 419  
   symbol defined 858  
 Data menu, CodeView 338–342  
 Data segments  
   *See also* Segments  
   attributes 501, 503  
   default *See* DGROUP  
   loading 475, 504  
   moving 504  
   packing 483  
   permissions 504  
   sharing 503–504  
 DATA statement 501  
 Database  
   browser *See* Browser database  
   help  
     context prefixes 613  
     creating 595–596  
     decoding 597–598  
     overview 594–595  
 Date, current, in PWB 155  
 Day, current, in PWB 155  
 .DBG files 473, 487, 860  
 Dbclick switch, PWB 244, 255  
 Debug command, PWB 66  
 Debugger defined 860  
 Debugging  
   *See also* CodeView  
   assembly language 389–392  
   /CO option, LINK 473

- Debugging (*continued*)
  - CodeView options 310–315, 317
  - CVW
    - commands 357–360
    - compared to CV 351–357
    - multiple applications 355–357
    - multiple instances 352–354
    - techniques 360–363
  - examining memory 32
  - identifying bugs 297
  - information
    - See also* Symbolic debugging information
    - defined 860
  - libraries 462
  - locating bugs 298
  - makefiles 530–531
  - p-code 363–367
  - packaged functions 481
  - packed files 476
  - programs
    - preparing 293–297
    - PWB 26
  - remote
    - bit rate 370
    - options 370–371
    - overview 367
    - requirements 368–370
    - starting a session 371–373
    - syntax 370
  - RND.ASM example 26
  - stepping through a program 28
  - syntax, TOOLS.INI file entries 302–308
  - watch expressions, setting 298–299
- Debugging information *See* Symbolic debugging information
- Debugging Information Compactor *See* CVPACK
- Decoding HELPMAKE options 597–598
- Decompressing
  - help database 598
  - help files, specifying buffer size 304
- Decorated names, debugging considerations 296
- .DEF files *See* Module-definition files
- Default
  - data segment *See* DGROUP
  - keys, PWB 132–140
  - libraries
    - defined 860
    - LINK 464–465, 479
- Define Mark command, PWB 65
- DEFINED operator, NMAKE 574
- Deflang switch, PWB 244, 255
- Defwinstyle switch, PWB 244, 256
- Delay command, CodeView 400, 450
- Delete command
  - LIB 588
  - PWB
    - described 64
    - predefined macros 133
- Delete function, PWB 141, 156
- Delete Watch command, CodeView 338–339, 399
- Delete Watch dialog box, CodeView 339
- Delete Watch Expressions command, CodeView 437
- DELETED directory, backup utilities 654
- Deleting
  - breakpoints, CodeView 341–342
  - characters, PWB 151, 157, 196
  - files
    - during debugging session 333
    - EXP 656
    - PWB 42
    - RM 654–655
  - lines, PWB 165–166
  - marks, PWB 167–168
  - text, PWB 156, 216–217
  - watch expressions, CodeView 339, 437
- Delimiters
  - help (>>) 609–610, 612
  - regular expressions, PWB 83
- Dependency
  - command 544
  - dependents
    - described 542
    - filenames 555–556
    - macros, predefined 555–556
  - described 538
  - extending a line 538
  - macros, predefined 555–556
  - PWB programs 39, 41
  - targets
    - described 538
    - filenames 555–556
    - macros, predefined 555–556
    - multiple description blocks 539
    - pseudotargets 540–541
  - time stamps 528
  - tree 538–539, 542, 563
  - wildcards 536
- Dependents
  - defined 528
  - described 542
  - filenames 546, 555–556
  - inferred 542, 563, 569–570
  - macros, predefined 555–556
  - paths 542
  - pseudotargets 541
- Dereference Global Handle command, CodeView 439–440

- Dereference Local Handle command, CodeView 441–442
- Dereferencing memory handles, CodeView 360
- Description blocks
  - commands 543
  - described 537
  - reusing targets 539–540
  - TOOLS.INI 534
- Description file *See* Makefiles; NMAKE
- DESCRIPTION statement 496–497, 518
- Destructors using C++ expressions 387–388
- DGROUP
  - attributes, viewing 518
  - defined 860
  - /DOSSEG option, LINK 474
  - segment number 519
- DH register, CodeView syntax 395, 426
- DI register, CodeView syntax 395, 426
- Dialog boxes
  - CodeView, getting help 669
  - defined 860
  - HELPMAKE context prefix 613
  - PWB
    - default key assignments 139
    - displaying 264–265, 268, 273
    - function 72–74
    - getting help 669
    - help 666, 671
- Dictionaries, extended 465, 479
- Dictionary
  - extended, /NOE option, LIB 585
  - extended, suppressing, LIB 585
  - in a library, LIB 586
- Digits, predefined expression syntax 846, 848, 853
- DIR command, replacing text, PWB 86–87
- Directives
  - makefile *See* Makefile; NMAKE
  - preprocessing, NMAKE 573–575
- Directories, listing .ASM files, PWB 86
- Disable Mouse in CodeView option 315
- Disabling
  - breakpoints, CodeView 341–342, 403–404
  - Mouse, CodeView option 315
- Disassembling defined 860
- DISCARDABLE attribute 503
- Display
  - CodeView
    - arranging 299
    - black-and-white display 312
    - line-display mode 311
    - memory format 330–332
    - overview 319–321
    - redrawing 454
    - screen exchange 313, 315, 345, 422–424, 454
    - specifying 310–311
  - Display (*continued*)
    - CodeView (*continued*)
      - suppressing snow 314
    - PWB
      - height 263
  - Display
    - specifying color 252, 254
    - width 284
    - screen, PWB 59
- Display Expression command, CodeView 400, 452–453
- Display modules, listing, CodeView 358
- DL register, CodeView syntax 395, 426
- .DLL files defined 860
- DLLs *See* Dynamic-link libraries
- /DO option, LINK 457
- .DOC files defined 860
- Dollar sign (\$)
  - end of line, syntax 845, 847, 849, 854
  - makefile syntax 536, 552, 554–556, 560, 562
  - match line end, syntax 847
  - reference to tagged expressions, syntax 848, 855
- DOS
  - applications defined 860
  - Extender defined 860
  - help, getting 676
  - keyword, EXETYPE statement 499
  - managing memory, browser database 617–618
  - redirection symbol (>), HELPMAKE syntax 597
  - session defined 860
- DOS Protected-Mode Interface server, memory management, CodeView 308
- DOS Shell command
  - CodeView 332–333
  - PWB 64, 132
- DOS shell, creating, PWB 201, 239
- DOS-extended defined 860
- /DOSS option, LINK 474
- /DOSSEG option, LINK 474
- Dot commands, HELPMAKE 597–598, 605–606, 608
- Dot directives, makefile *See* Makefiles; NMAKE
- Double precision defined 860
- Down function, PWB 141, 157
- DPMI
  - defined 8561
  - server *See* DOS Protected-Mode Interface server
- Dragging defined 861
- /DS option
  - HELPMAKE 598, 681
  - LINK 475
  - PWB 131
- DS register
  - CodeView syntax 395, 426
  - /DSALLOC option, LINK 475
  - /DSALLOC option, LINK 475



- /DSALLOCATE option, LINK 475
  - /DT option, PWB 131
  - /Du option, HELPMMAKE 598
  - Dumping
    - defined 861
    - math registers, CodeView 448–449
    - memory, CodeView 414–415
  - DW operator, CodeView 381, 390–392
  - DX register, CodeView syntax 395, 426
  - /DY option, LINK 475
  - Dynamic
    - address, viewing memory, CodeView 331
    - links defined 861
  - Dynamic Data Exchange, debugging 354–357
  - /DYNAMIC option, LINK 475
  - Dynamic-link libraries
    - See also* Windows, programs for
    - creating, LINK 459, 466
    - debugging p-code 364
    - defined 861
    - EXEHDR output 519
    - export ordinals 505
    - initialization address 519
    - initialization routine, debugging 356–357
    - LIBRARY statement 496
    - listing modules, CodeView 358, 439
    - loading symbolic information, CodeView 314
    - loading, CodeView 337–338
    - name 496
    - PRIVATELIB 496
    - values, CodeView 299–300
- E**
- E command, CodeView 398, 408, 429
  - e, predefined expression, syntax 846, 848, 855
  - e. context prefix, HELPMMAKE 613
  - :e command, HELPMMAKE 606
  - /E option
    - HELMMAKE 595–596
    - LINK 475
    - NMAKE 530, 561, 563
    - PWB 132
  - /EAX register, CodeView syntax 395, 426
  - EBP register, CodeView syntax 395, 426
  - EBX register, CodeView syntax 395, 426
  - ECX register, CodeView syntax 395, 426
  - \_\_edata variable 474
  - EDI register, CodeView syntax 395, 426
  - Edit Breakpoints command, CodeView 338, 341–342
  - Edit Breakpoints dialog box, CodeView 341–342
  - Edit menu
    - CodeView 334–335
    - PWB
  - Edit menu (*continued*)
    - PWB (*continued*)
      - described 64
      - functions 133
      - predefined macros 133
  - Edit Project command, PWB 66
  - Editing
    - breakpoints, CodeView 341–342
    - CONFIG.SYS, PWB 58
    - files, Editreadonly switch, PWB 256
    - macros, PWB 101
    - Noedit function, PWB 178–179
    - projects, PWB 41–42, 49
    - repeat function, PWB 192
    - text, menu commands, PWB 64
  - Editor, PIF, starting PWB 58
  - Editor Settings command, PWB 67, 675
  - Editreadonly switch, PWB 244, 256
  - EDX register, CodeView syntax 395, 426
  - EGA defined 861
  - Ei option, BSCMAKE 620
  - /El option, BSCMAKE 620
  - Ellipsis (...)
    - call tree, PWB 92
    - menu command, PWB 72, 74, 116
  - !ELSE preprocessing directive, NMAKE 573
  - !ELSEIF preprocessing directive, NMAKE 573
  - !ELSEIFDEF preprocessing directive, NMAKE 573
  - !ELSEIFNDEF preprocessing directive, NMAKE 573
  - /Em option, BSCMAKE 620
  - Emacscdel function, PWB 141, 157
  - Emacsnewl function, PWB 141, 158
  - EMM386.EXE
    - CodeView 308, 310
    - defined 861
  - EMM.386.SYS, CodeView 308, 310
  - EMS defined 861
  - Emulators defined 861
  - Enablealtgr switch, PWB 244, 257
  - Enabling breakpoints, CodeView 341–342, 404–405
  - Encoding HELPMMAKE options 596–597, 611
  - .end command, HELPMMAKE 606
  - \_\_end variable 474
  - Endfile function, PWB 141, 158
  - !ENDIF preprocessing directive, NMAKE 573
  - Endline function, PWB 141, 158
  - English word, predefined expression syntax 846, 848, 853
  - Enhanced graphics adapter defined 859
  - Entab switch, PWB 118–119, 244, 257–258
  - Enterinsmode switch, PWB 244, 258
  - Enterlogmode switch, PWB 244, 259
  - Enterselmode switch, PWB 244, 259
  - Envcursave switch, PWB 128, 245, 259–260
  - Environment function, PWB 141, 159, 160

- Environment strings defined 861
- Environment tables
  - change in CodeView 294
  - defined 861
  - saving, in PWB 259–260
- Environment variables
  - defined 859
  - HELPPFILES
    - defined 861
    - help file location 679
    - opening help files 677
    - restricting global search 675
  - INCLUDE 620
  - INIT
    - defined 862
    - remote debugging 371
    - use, 534
  - LIB 466, 862
  - LINK 488–489, 862
  - makefiles 530, 561–562
  - menu commands, PWB 67
  - NMAKE 534
  - PATH, installing CodeView 299
  - PWB
    - function 159–160
    - starting 59
    - TOOLS.INI file 127–128
  - SET command 562–563
  - SYSTEM, defined 868
  - TEMP defined 869
  - TMP 490, 548, 869
- Environment Variables command, PWB 67
- Envprojsave switch, PWB 128, 245, 260
- Equal sign (=)
  - .DEF file syntax 494
  - makefile syntax 551, 560
  - Redirect Input and Output command, CodeView 400, 452
- /Er option, BSCMAKE 620
- .ERR files defined 861
- Error bit
  - checking, EXEHDR 519
  - clearing, EXEHDR 515
  - linking 481
- Error codes
  - BSCMAKE 623
  - CVPACK 633
  - defined 861
  - LIB 592
  - LINK 490
  - makefiles 531, 544–545, 571
  - NMAKE 580
  - SBRPACK 626
- !ERROR directive 572
- Error messages, getting help 671–672
- Error numbers, HELPMMAKE context prefix 613
- Errors
  - building a PWB program 40
  - defined 867
  - help, getting 671–672
  - menu commands, PWB 66
  - simulating in CodeView 360, 440–441
- /Es option, BSCMAKE 620
- ES register, CodeView syntax 395, 426
- Escape sequence
  - CodeView expressions 385
  - defined 861
- Escapes, regular expression syntax 845, 847–848, 854
- ESI register, CodeView syntax 395, 426
- ESP register, CodeView syntax 395, 426
- Eval entry, TOOLS.INI file
  - CodeView 299–300, 302–303, 380
  - remote debugging 368–369
- Examine Symbols command, CodeView 399, 443
- Exception-mask bits, 8087 command, CodeView 448–449
- Exclamation point (!)
  - HELPMMAKE command 602
  - makefile syntax 544, 572
  - replacing text, PWB 86
  - Shell Escape command, CodeView 399, 443–445
- EXE File Header Utility *See* EXEHDR
- .EXE files defined 861
- Executable files
  - alignment, EXEHDR 522
  - application type 485, 495, 514, 523
  - checksum 518, 522
  - .COM file 487
  - creating *See* LINK
  - defined 861
  - error bit
    - checking, EXEHDR 519
    - clearing, EXEHDR 515
    - linking 481
  - header
    - See also* EXEHDR
    - format 515
    - size 517
  - heap *See* Heap
  - inserting text 496
  - linker version 522
  - loading 477
  - memory allocation
    - EXEHDR 514
    - LINK 473
  - MS-DOS stub 497
  - name of program
    - EXEHDR 518–519
    - LIBRARY statement 496

- Executable files (*continued*)
- name of program (*continued*)
    - NAME statement 495
  - name, LINK 462
  - operating system
    - .DEF file 491
    - EXEHDR 521
  - packing
    - determining, EXEHDR 517
    - iterated (segment attribute) 523
  - relocations *See* Relocations
  - segments *See* Segments
  - size
    - /ALIGN option, LINK 472
    - EXEHDR 517
    - /EXEPACK option, LINK 476
  - stack *See* Stack
  - starting address, EXEHDR 518
  - Windows, programs for *See* Windows, programs for
- .execute command, HELPMAKE 606
- Execute command, PWB 66
- Execute Commands option, CodeView 312–313
- Execute function, PWB 98, 141, 160
- EXECUTEONLY, EXECUTE-ONLY attribute 503
- EXECUTEREAD attribute 503
- Executing
- commands, PWB 70–74, 132, 205
  - functions, PWB 96–98, 160
  - macros, PWB 96–98
- Execution
- controlling, CodeView 361
  - model, specifying, CodeView 305
- EXEHDR
- 32-bit checksum 522
  - address (in segment table) 520
  - application type 514, 523
  - bytes on last page 517
  - checksum 518
  - command line 513–514
  - copyright message 514
  - data 518–519
  - description (in output) 518–519
  - DGROUP
    - (in output) 519
    - attribute 518
    - segment number 519
  - DLL output 519
  - entry point 518
  - entry table 522
  - error bit
    - checking 519
    - clearing 515
  - .EXE size 517
  - exports table 520, 523
- EXEHDR (*continued*)
- extra paragraphs needed 517
  - extra stack allocation 518
  - file
    - in segment table 520
    - size 517
    - system, installable 514
  - flags (in segment table) 520
  - full information 515
  - header
    - format 515
    - size 517
  - heap
    - allocation (in output) 522
    - setting 514
    - size 522
  - help 514–515
  - imported names table 522
  - initial CS, IP 518–519
  - initial SS, SP 518–519
  - initial stack location 517
  - initialization 519
  - iterated (segment attribute) 523
  - library 519
  - linker version 522
  - magic number 517
  - mem (in segment table) 520
  - memory
    - allocation 514
    - needed 518
    - requirement 517–518
  - module 518, 522
  - movable entry points 522
  - name
    - (in exports table) 521
    - of program 518–519
  - new .EXE header address 521
  - no. (in segment table) 520
  - non-resident names table 522
  - offset
    - (in exports table) 521
    - (in relocations) 524
  - operating system 521
  - options 514–515
  - ord (in exports table) 521
  - other module flags 523
  - output
    - dynamic-link libraries 518, 521
    - MS-DOS header 516, 521
    - segmented executable files 518, 521
    - verbose output 521, 630
    - Windows, programs for 518, 521
  - overview 513

EXEHDR (*continued*)

- packed .EXE file
  - iterated (segment attribute) 523
  - MS-DOS header 517
- pages in file 517
- paragraphs in header 517
- relocations 517–518, 523, 630
- relocs (segment attribute) 523
- reserved words (in MS-DOS header) 521
- resident names table 522
- resource table 522
- running 513
- seg (in exports table) 521
- segment
  - attributes 519, 523
  - number (in relocations) 524
  - sector size 522
  - table 520, 522–523
- stack
  - address 517–518
  - setting 515
  - size 518
- starting address 518
- syntax 513–515
- target (in relocations) 524
- type
  - (in relocations) 524
  - (in segment table) 520
- verbose output 515
- word checksum 518

/EXEPACK option, LINK 297, 475

EXETYPE statement

- described 498
- STUB statement interaction 497

EXIST operator, NMAKE 574

Exit codes

- BSCMAKE 623
- CVPACK 633
- defined 861
- LIB 592
- LINK 490
- makefiles 531, 544–545, 571
- NMAKE 580
- SBRPACK 626

Exit command

- CodeView 332–334
- PWB 64, 132

Exit function, PWB 141, 160–161

Exiting

- CodeView 334
- PWB 41, 160–161, 233–234

EXP

- command line 656
- options 656

EXP (*continued*)

- overview 631, 654
- syntax 656

Expanded memory

- defined 862
- emulator defined 862
- manager defined 862

Expanding elements in CodeView 342, 453–454

EXPDEF record 460

Explicit

- allocation 509, 862
- links, HELPMMAKE 602
- \_\_export keyword 460, 505

Exported functions

- See also* Imported functions
- EXPORTS statement 505
- linking 464–465
- name
  - EXEHDR 521
  - EXPORTS statement 506
- OLD statement 505
- ordinal number
  - EXEHDR 521
  - EXPORTS statement 506
- table, EXEHDR 520, 523

EXPORTS statement

- See also* Exported functions
- described 505
- name, EXEHDR 521
- ordinal number, EXEHDR 521

Expression evaluators, CodeView and MASM 380

- choosing 380, 430
- defined 375
- listing 344
- numbers 384
- operators 381–384
- specifying 303
- string literals 385
- symbol format 385–386

Expressions

- address ranges 379, 396–397
- addresses 378, 396
- C++, in CodeView 386–388
- constant, defined 857
- defined 862
- displaying, CodeView 452–453
- editing, CodeView 324–325
- line number 376, 394
- live, creating 331
- overview, CodeView 375
- predefined *See* Predefined expressions syntax
- preprocessing directives, NMAKE 574–575
- regular *See* Regular expressions

- Expressions (*continued*)
    - registers 377, 395
    - setting breakpoints, CodeView 340
    - tagged *See* Tagged expressions
    - watch *See* Watch expressions
  - Expunging files *See* EXP
  - Extended ASCII defined 862
  - Extended dictionaries
    - defined 862
    - generally 465, 479
    - suppressing, LIB 585
  - Extended memory
    - browser database 617–618, 621
    - defined 862
    - Keepmem switch, PWB 265
  - Extended memory manager
    - CodeView 308
    - defined 862
  - Extending line *See* Line continuation
  - Extension switches, PWB 246
  - Extensions
    - autoloading, PWB 121–122, 249–250
    - Curfileext predefined macro, PWB 211
    - default, PWB 255
    - defined 862
    - IMPLIB 653
    - loading, PWB 266
  - External references 464–465, 862
  - EXTERNDEF directive generated by H2INC 640
- F**
- F option, CodeView 310
  - f, filenames, predefined expression syntax 844, 846, 851
  - /F option
    - CodeView 313
    - LINK 476
    - NMAKE 530
    - RM 655
  - F1 key, getting help 665–666
  - Factor switch, PWB 245, 261
  - Far address defined 862
  - Far calls, optimizing 476, 479, 482
  - /FARCALL option, LINK 476
  - /FARCALLTRANSLATION option, LINK 476
  - \_fastcall keyword, symbol format, CodeView 385–386
  - Fast functions, PWB switches 261
  - Fastfunc switch, PWB 245, 262
  - FAT defined 862
  - Fatal errors
    - defined 862
    - simulating, CodeView 360, 440–441
  - /FBr option and BSCMAKE 616
  - /FBx option and BSCMAKE 616
  - .FD files defined 862
  - FFLAGS macro (NMAKE) 559
  - .FI files defined 862
  - Fields *See* specific tool
  - File allocation table defined 860
  - File Expunge Utility *See* EXP
  - File handle defined 860
  - File Header Utility *See* EXEHDR
  - File history, setting maximum files 279
  - File menu
    - CodeView 332–334
    - PWB
      - described 64
      - predefined macros 132
  - File Removal Utility *See* RM
  - File Undelete Utility *See* UNDEL
  - Filehistory, PWB 64
  - Filename extensions
    - autoloading, PWB 249–250
    - Curfileext predefined macro, PWB 211
    - default, PWB 255
    - defined 862
    - IMPLIB 653
    - loading, PWB 266
  - filename! command, HELPMMAKE 602
  - Filename-extension tags, TOOLS.INI file, PWB 123
  - Filename-Parts Syntax, PWB switches 247
  - Filenames
    - base names
      - Curfilenam predefined macro, PWB 211
      - defined 856
      - Shortnames switch, PWB 275
    - defined 862
    - long, in makefiles 537
    - makefiles 546, 555–556
    - predefined expression syntax 846, 848, 853
    - specifying, HELPMMAKE 596, 598
    - wildcards 536
  - Files
    - adding, PWB 38–41, 44
    - backing up, PWB 87, 281, 654–656
    - backup *See* Backup files
    - .BSC 615, 618
    - closing, PWB 64, 153, 217–218
    - CodeView requirements 300–301
    - command *See* Command files; Response files
    - compacting for CodeView, CVPACK 631–632
    - compiling, PWB 218–219
    - creating, PWB 227
    - .DEF files *See* Module-definition files
    - deleting
      - during debugging session 333
      - PWB 42
      - RM 654–655

- editing, Editreadonly switch, PWB 256
- estimating size, PWB 94
- executable *See* Executable files
- expunging 656
- finding, PWB 64
- header *See* Include files
- help
  - See also* Help files
  - rich text format 609–611
- include
  - See also* Include files
  - in browser database *See* Browser database
  - INCLUDE statement 510
- inline, in makefiles *See* Inline files
- listing, PWB 86
- loading, PWB 132
- long names
  - in makefiles 537
  - NAME statement 496
  - /NEWFILES option, EXEHDR 514
- make *See* Makefiles
- MAKEFILE 529–530
- map, LINK 463, 478
- module-definition *See* Module-definition files
- moving
  - PWB 42
  - RM 654–655
- opening, PWB 64, 131, 179, 269
- printing
  - CodeView 333
  - PWB 182–183
- project file list, PWB 38
- relocatable 459
- remote debugging 368–370
- response *See* Command files; Response files
- restoring, UNDEL 655
- saving
  - Autosave switch, PWB 250
  - PWB 64, 195, 237–238, 279
- .SBR 616
- searching, PWB 78–82
- segmented executable *See* Segmented executable files
- source *See* Source files
- source, dot commands 605–608
- specifying type, HELPMAKE 597
- startup, PWB 127
- state *See* State file, CodeView
- status, PWB 128–129
- temporary, LINK 489–490
- time stamps *See* Time stamps
- TOOLS.INI, makefiles 534–535, 552, 572
- Filetab switch, PWB 118, 245, 262
- \fin formatting code, HELPMAKE 610
- Find command
  - CodeView 335–336
  - PWB 64–65, 79–82
- Find Dialog box, CodeView 335–336
- Finding
  - files, PWB 64
  - symbol definitions, PWB 90–93
  - text, in PWB 83–85
    - Mreplace function 173–174
    - Mreplaceall function 174
    - Qreplace function 189
    - Replace function 192–193
- FIXED attribute 504
- Fixup defined 862
- Flags
  - 8087 command, CodeView 448–449
  - changing values, CodeView 426–428
  - displaying value, CodeView 329–330
  - register defined 862
- FLAGS macro (NMAKE) 559
- Flat memory model defined 863
- Flipping screen exchange
  - CodeView 313, 422–424
  - defined 863
- Flow control statements 102–104
- .FOR files defined 863
- FOR macro (NMAKE) 559
- Foreign makefiles in PWB 55–56
- Format
  - commands, CodeView 326–327, 393
  - HELPMAKE
    - described 599
    - QuickHelp 600–606, 608
    - rich text format 609–611
  - memory, changing 331
- Formatting
  - attributes, HELPMAKE, QuickHelp format 602, 604–605
  - codes, HELPMAKE, rich text format 610
  - text, HELPMAKE topics 604–605
- Forward slash (/)
  - EXEHDR syntax 514
  - LIB syntax 584
  - LINK syntax 471
  - NMAKE syntax 529
- /FR option and BSCMAKE 616
- /Fr option and BSCMAKE 616
- Frames defined 863
- .freeze command, HELPMAKE 606
- Friction switch, PWB 245, 263
- FULL, /MAP option 478
- Full-screen application defined 863
- Function calls defined 863
- Function Hierarchy command, PWB
  - described 68

Function Hierarchy command, PWB (*continued*)

function 134

Function-level linking 484, 508

Functions

anonymous 509

assigning 508

calling CodeView expressions 382

defined 863

explicit allocation 509

exported *See* Exported functions

external references 464–465

imported *See* Imported functions

listing, CodeView 411–412

ordered 508

overlaid 508–509

packaged

FUNCTIONS statement 508

/NOPACKF option, LINK 481

/PACKF option, LINK 484

PWB

Arg 86, 96–98

Assign 98, 111–112, 114

Backtab 118

call tree 91–92

closing 206

described 140–141, 146–206

executing 96–98

Linsert 98

listing references 92

mark 78

menu commands 132–135

Meta 97–98

modifying 170

Paste 86, 98

Prompt 106

Psearch 97

tabs 118–119

Tell 98

tracing, CodeView 428

FUNCTIONS statement described 508

## G

G command, CodeView 398, 409–410

:g command, HELPMMAKE 607

G option, CodeView 310

/G option, CodeView 314

Gigabyte defined 863

Global contexts, help files, linking 603–604

Global

heaps, listing memory objects, CodeView 357, 437  
–438

memory handles, converting to pointers 439–440

symbols

Global (*continued*)

symbols (*continued*)

defined 863

searching for, CodeView 382,–384

Global Search command, PWB 70, 674–675

GlobalLock function in CodeView 439

GlobalLock routine, locking memory handles 360–361

Go command, CodeView 398, 409–410

Goto command, predefined macros, PWB 134

GOTO Definition command, finding symbols, PWB 90  
–91

Goto Definition command, PWB function 68, 134

Goto Error command described, PWB 66

Goto Mark command, PWB 65

Goto Match command, PWB

described 65

predefined macros 133

Goto Reference command, PWB 68, 134

Grandparent process defined 863

Graphic function, PWB 141, 161

Greater than operator (>), Redirect Input command,  
CodeView 312–313, 400–451

Green color value 254

Group defined 863

## H

H command, CodeView 398, 410

.H files defined 863

h, hexadecimal number, syntax 846, 848, 853

/H option

CVPACK 633

IMPLIB 653

LIB 585

H2INC

and BASIC langtype specification 648

and C return types 648

and \_cdecl langtype specification 648

and \_fastcall functions 649

and FORTRAN langtype specification 648

and negative numbers in expressions 640

and non-constant integer expressions 638

and Pascal langtype specification 648

and predefined constants 638

and static function prototypes 648

and user-defined constants 638

C data types (list) 640

C prototype conversion, examples 649

command-line options (lists) 636

converting

C bit fields 645

C enumerations 647

C type definitions 647

comments 635

H2INC (*continued*)

- converting (*continued*)
  - constants 638
  - function prototypes 648–649
  - nested structures 644
  - pointers 642
  - records 645
  - structures 642–643
  - unions 642–643
  - variables 640
- converting function prototypes
  - and /Mn option 649
  - syntax 648
- naming considerations 642
- new features 633–634
- overview 634
- predefined constants (list) 639
- recognized C preprocessor keywords (list) 652
- recognized C preprocessor pragmas (list) 652
- syntax 635
- type definitions 647, 649
- /U and /u options and /D option 640

Handlers, symbol, specifying 306–308

/HE option, LINK 477

/HEA option, EXEHDR 514

Header, file

- See also* Include files
- examining and changing *See* EXEHDR
- format 515
- size 517

/HEAP option, EXEHDR 514

Heaps

- global, listing memory objects 357, 437–438
- local, listing memory objects 358
- setting
  - .DEF file 500
  - EXEHDR 514
- size
  - EXEHDR 522
  - limit 500

HEAPSIZE statement 500

Height switch, PWB 245, 263

/HEL option, EXEHDR 514

Help

- See also* CodeView; Help files; Microsoft Advisor;
- Quickhelp
- displaying in PWB 8, 185, 221, 223
- getting
  - CodeView 664–673
  - HELPMAKE 598
- index table, PWB 223–224
- load state, PWB 219–220
- next topic, PWB 186, 220
- previous topic, PWB 221

Help (*continued*)

- searching, PWB 186–187, 224
- structure, CodeView 663
- switches 288–290
- topic selection, PWB switch 289
- topic, PWB 222

Help command

- CodeView 347–348, 398, 410
- PWB 69

Help database

- compressing 595–596
- context prefixes 613
- creating 595–596
- decoding 597–598
- decompressing 598
- overview 594–595

Help delimiters (> >), HELPMAKE 609–610, 612

Help File Maintenance Utility *See* HELPMAKE

Help files

- closing
  - PWB 200
  - QuickHelp 677
- concatenating 680
- creating 595–596
- decoding 597–598
- decompressing 304
- formats
  - described 599
  - minimally formatted ASCII 612
  - QuickHelp 603–606, 608
  - rich text format 609–611
- listing 289, 305, 680
- locking 597
- managing 679–681
- opening
  - Microsoft Advisor 673
  - PWB 200
  - QuickHelp 677
- overview 594–595
- requirements, CodeView 300–301
- specifying 597
- splitting 681
- topics, defining 600–601

Help menu

- CodeView 349, 665
- PWB 70, 135, 665

Help on Help command

- CodeView 349
- PWB 70, 135, 665

HELP option, HELPMAKE 599

/HELP option

- BSCMAKE 620
- CVPACK 633
- EXEHDR 514



- /HELP option (*continued*)
    - EXP 656
    - IMPLIB 653
    - LIB 585
    - LINK 477
    - NMAKE 530
    - RM 655
    - SBRPACK 625
    - UNDEL 656
    - using 676
  - Help window
    - CodeView
      - function 332
      - opening 348
      - overview 322
      - using 667, 669
    - PWB
      - default key assignments 139
      - using 667, 669
      - setting size 288
  - Helpautosize switch, PWB 288
  - Helpbuffer entry, TOOLS.INI file, CodeView 302, 304
  - helpfile! contextstring command, HELPMMAKE 602
  - Helpfiles entry, TOOLS.INI file, CodeView 302, 305
  - HELPPFILES environment variable
    - defined 863
    - help file location 679
    - opening help files 677
    - restricting global search 675
  - Helpfiles switch, PWB 289, 675
  - Helplist switch, PWB 289
  - HELPMMAKE 596
    - compatibility 593
    - context prefixes 613
    - decoding 597–598
    - defining topics 600–601
    - dot commands 605–606, 608
    - encoding 595–597, 611
    - formats
      - described 599
      - minimally formatted ASCII 612–613
      - QuickHelp 600–603, 605–606, 608
      - QuickHelp format 602–605
      - rich text format 609
      - rich text format 610–611
      - specifying 597
    - formatting attributes 602–605
    - formatting text 604–605
    - getting help 598
    - global contexts 603–604
    - local contexts 603–604
    - options
      - decoding 597–598
      - encoding 596–597
  - HELPMMAKE 596 (*continued*)
    - overview 594–595
    - syntax 595–599
  - Helpwindow switch, PWB 289–290
  - Hexadecimal
    - defined 863
    - numbers, predefined expression syntax 844, 846, 851
  - /HI option, LINK 477
  - /HIGH option, LINK 477
  - High memory defined 863
  - Highlight defined 863
  - Highlighting search strings in PWB 196, 197
  - Hike switch, PWB 245, 264
  - HIMEM.SYS
    - CodeView 308
    - defined 863
  - .HLP files defined 863
  - Home function, PWB 141, 161
  - Horizontal Scrollbars command, CodeView 342, 345
  - HPFS defined 863
  - Hscroll switch, PWB 245, 264
  - Huge memory model defined 863
  - Hyperlinks, Microsoft Advisor
    - index screens 672
    - navigating with 666–668
- I**
- I command, CodeView 398, 410–411
  - :i command, HELPMMAKE 607
  - I option, CodeView 310
  - /I option
    - CodeView 314
    - LIB 585
    - LINK 477
    - NMAKE 531
    - RM 655
  - i, C/C++ identifier, syntax 846, 848, 853
  - \i formatting attribute, HELPMMAKE 604–605
  - \i formatting code, HELPMMAKE 610
  - Identifiers
    - C/C++, syntax 846, 848, 853
    - case sensitivity 480
    - defined 863
    - searching, PWB 85
  - IEEE format defined 864
  - !IF preprocessing directive, NMAKE 573
  - !IFDEF preprocessing directive, NMAKE 573
  - !IFNDEF preprocessing directive, NMAKE 573
  - /IGN option, LIB 585
  - .IGNORE directive 571
  - /IGNORECASE option, LIB 585
  - IMPLIB
    - case sensitivity 653

IMPLIB (*continued*)

- command lines 653
- .DEF files 493
- EXPORTS statement 506
- IMPORTS statement 506
- linking import libraries 464
- options 653
- overview 631, 652–653
- syntax 653

Implicit links, HELPMAKE 603

Import libraries

- creating, IMPLIB 652–653
- .DEF files 493
- defined 864
- EXPORTS statement 506
- IMPORTS statement 506
- linking 459, 464

Import Library Manager *See* IMPLIB

Imported functions

- See also* Exported functions
- EXEHDR 522
- IMPORTS statement 506
- name 507
- OLD statement 505

IMPORTS statement

- See also* Imported functions
- described 506

IMPURE attribute 504

.INC files defined 864

INCLUDE directive, PWB project dependencies 39

INCLUDE environment variable 620

Include files

- defined 864
- finding symbols, PWB 92
- in browser database *See* Browser database
- project dependencies, PWB 39, 41

!INCLUDE preprocessing directive, NMAKE 572

INCLUDE statement described 510

/INCR option, LINK 457

Incremental linking 457

Indenting text

- HELMAKE 610
- PWB 275

Index

- Microsoft Advisor 670
- screens, Microsoft Advisor 672

Index command

- CodeView 349
- PWB 70, 135, 665

Indirection register, debugging, assembly language 391

Inference rules

- command macros 558–559, 568
- commands 543, 564
- defining 564–567

Inference rules (*continued*)

- dependents, inferred 542, 563, 569–570
- described 563
- displaying 531
- ignoring 532
- macros
  - in definition 564
  - predefined 558–559, 568
- NMAKE-supplied 567–568
- paths 565, 566
- precedence 570
- predefined 567–568
- priority 564
- recursion 558
- rules 564–570
- .SUFFIXES 532, 563, 565, 568,–571
- syntax 564–567

Inferred dependents 542, 563, 569–570

Infinite loops, terminating execution 362

/INFO option, LINK 477

Infodialog switch, PWB 264–265

Information function, PWB 141, 162

/INFORMATION option, LINK 477

Inheritance, makefile

- described 557–558
- macros 557, 563
- /V option, NMAKE 532

Inheritance, using C++ expressions 386

.INI files defined 864

INIT environment variable 534

- defined 864
- PWB 127
- remote debugging 371
- starting PWB 59

Initialization routine, debugging 356–357

Initialize function, PWB 141, 162

Inixre switch, PWB 246

Inline

- code, debugging 294
- files 547,–550
- functions
  - debugging at the source level 294
  - source level debugging, workaround 294

Input, redirecting, CodeView 450, 452

Insert

- function, PWB 141, 163
- mode, toggling, in PWB 163, 258

Inserting

- characters, PWB 163
- lines, PWB 166–167
- RTF formatting codes, HELPMAKE 610
- space, PWB 201–202

Insertmode function, PWB 141, 163

Installable file system  
 defined 864  
 EXEHDR /NEWFILES option 514  
 NAME statement 496  
 Installing CodeView 299–301  
 int, searching, PWB 83–85  
 Integers defined 864  
 Interoverlay calls  
 defined 864  
 /DYNAMIC option, LINK 475  
 Interrupt call defined 864  
 Interrupt number, overlays 482  
 Interrupting CodeView 361, 445, 450  
 Interrupts, trapping, CodeView 314  
 Intrinsic functions, calling, CodeView expressions 382  
 I/O privilege mechanism defined 864  
 Italics, HELPMMAKE formatting  
 QuickHelp format 604–605  
 rich text format 610  
 iterated (segment attribute) 523

## J

Justifying tagged expressions 852

## K

K command, CodeView 411–412  
 /K option  
 HELPMMAKE 596–597  
 NMAKE 531  
 RM 655  
 KEEP, inline file 548  
 Keepmem switch, PWB 245, 265  
 Key assignment, PWB 97, 109–111, 125–126  
 Key assignments, PWB  
 cursor movement commands 144  
 default 135–140  
 Graphic function 161  
 menu commands 132–135  
 Unassigned function 204  
 Key Assignments command, PWB 67  
 Key box, assigning key function, PWB 110  
 Keyboard  
 choosing commands 70–71  
 executing PWB commands 70–71  
 hyperlinks, activating 667  
 navigation in CodeView 323  
 shortcut keys, PWB 71  
 Keys  
 shortcut, PWB 71  
 TOOLS.INI syntax, PWB 125–126  
 Keywords  
*See also* Reserved words

Keywords (*continued*)  
 compressing, HELPMMAKE option 596–597  
 help, getting 669, 671  
 Kilobyte defined 864

## L

L command, CodeView 398, 412–413  
 :l command, HELPMMAKE 606  
 L option, CodeView 310  
 /L option  
 CL 355–357  
 HELPMMAKE 597  
 LINK 478  
 /L options, CodeView 314  
 Label defined 864  
 Label/Function command, CodeView 335–336  
 Language command, CodeView 342, 344  
 Language dialog box, CodeView 344  
 Language Options command, PWB 67  
 Large memory model defined 864  
 Lastproject switch, PWB 131, 245, 265–266  
 Lastselect function, PWB 141, 164  
 Lasttext function, PWB 141, 164–165  
 Ldelete function, PWB 141, 165–166  
 Leaving  
 CodeView 334  
 PWB 160–161, 234  
 Left function, PWB 141, 166  
 .length command, HELPMMAKE 606, 609  
 Less than operator (<), Redirect Output command,  
 CodeView 312–313, 450  
 LIB  
*See also* LIB; Libraries  
 adding a module 587–588  
 case sensitivity 585  
 combining libraries 588  
 command line 582  
 commands  
 Add (+) 587–588  
 Copy (\*) 589  
 Delete (-) 588  
 Move (-\*) 589  
 Replace (-+) 589  
 specifying 586  
 consistency check 584  
 copying a module 589  
 copyright message 585  
 creating a library 584, 587  
 cross-reference listing 590  
 defaults  
*See also* specific option or field  
 command line 582  
 listing filename 590

## LIB (continued)

- deleting a module 588
- error codes 592
- exit codes 592
- extended dictionary, suppressing 585
- extending a line 586
- extracting a module 589
- fields
  - commands 586–587
  - described 583
  - listfile 590
  - newlibrary 588, 590
  - oldlibrary 584, 588
  - options 584–586
  - specifying 582–583
- file types, input 581
- help 585–586
- input 584
- limits
  - command line 583
  - library size 586
- line continuation 586
- listing 584, 590
- memory 585
- modules list 590
- moving a module 589
- naming a library 584, 590
- options
  - /? 586
  - /HELP 585
  - /IGN 585
  - /NOE 585
  - /NOI 585
  - /NOL 585
  - /PAGE 585–586
  - described 584
  - rules 584
- output 584
- output library 590
- overview 581
- page size 585–586
- prompts 582–584
- removing a module 588–589
- replacing a module 589
- response file 583
- return codes 592
- running 582
- saving a library 590
- symbols list 590
- syntax 582–583
- updating a module 589

LIB environment variable 466, 864

.LIB files defined 864

LibEntry routine, debugging 356–357

## Libraries

*See also* LIB

- combining *See* LIB
- comment pragma 465
- creating *See* LIB
- default 464–465, 479, 858
- defined 864
- dynamic-link *See* Dynamic-link libraries
- extended dictionaries 465, 479
- formats 581
- import *See* Import libraries
- linking 463–466
- linking, LIB 581
- load 462
- load defined 863
- search order 465–466
- size, LIB 586
- standard 581
- standard, defined 868
- static, defined 868

Library files, PWB 38

Library Manager *See* LIB

LIBRARY statement

- described 496
- initialization, EXEHDR 519
- name, EXEHDR 519

LIM EMS defined 864

\in formatting code, HELPMMAKE 610

.line command, HELPMMAKE 606

Line continuation

- command, makefile 543
- dependency, makefile 538
- LIB command line 586
- LINK command line 461, 463, 469–470
- macro definition, makefile 551

Line continuation character (\), PWB 105, 107, 126

\line formatting code, HELPMMAKE 610

Line Mode command, PWB 64, 133

Line numbers

- CodeView expressions 376, 394
- /LINE option, LINK 478
- /LINE option, LINK 478

Line selection mode, setting in PWB 224–225

Line-display mode, setting, CodeView 311

/LINENUMBERS option, LINK 478

Lines

- deleting, PWB 165–166
- inserting, PWB 166–167
- multiple statements, debugging 294
- trailing, display mode, in PWB 280

LINK

- alignment 472
- application type 485
- case sensitivity 480

LINK (*continued*)

- .COM file 487
- command line 460–466, 468
- copyright message 480
- CVPACK 457
- .DBG file 473, 487
- debugging 473
- .DEF file
  - See also* Module-definition files specifying 466
- default libraries 464–465, 479
- defaults
  - See also* specific option or field
  - input 462
  - output 459
  - prompts 469
- directories 463
- DLLs
  - See also* Dynamic-link libraries
  - creating 459
  - .DEF file 466–467
- environment variable 862
- environment variables
  - LIB 466
  - LINK 488–489
  - TMP 490
- error
  - bit 481
  - codes 490
- errors
  - symbol defined more than once 465
  - symbol multiply defined 465
  - unresolved external 465, 479
- exit codes 490
- extending a line 463
- external references 464–465
- far calls 476, 479, 482
- fields
  - deffile 466
  - exefile 462
  - libraries 463–465, 466
  - mapfile 463
  - objfiles 461–462
- function-level linking 484, 508
- functions
  - ordered 508
  - packaged *See* Packaged functions
- halting 461, 468
- help 477, 488
- ILINK 457
- import libraries 464
- information 477–478
- input 468
- interoverlay calls 475

LINK (*continued*)

- interrupting 461, 468
- libraries 459, 462–466, 479
- library search order 465–466
- library search record 465
- limits
  - command line 469
  - interoverlay calls 475
  - libraries 463
  - program size 459, 472
  - segments 483, 486
  - stack size 487
- line numbers 478
- mapfile 463, 478
- memory
  - allocation 473
  - loading 475, 477
  - requirement 486
- module-definition file
  - See also* Module-definition files specifying 466
- MS-DOS programs
  - See also* MS-DOS programs
  - creating 459
- name
  - executable file 462
  - mapfile 463
- new features 457–458
- NOEXE 481
- NUL.DEF 467
- null bytes 474, 480
- object files 461–462
- operating system requirements 457
- optimizing
  - far calls 476, 479, 482
  - load time 476
  - relocations 475
- options
  - /? 488
  - /ALIGN 472
  - /BATCH 472
  - /CO 473
  - /CPARM 473
  - debugging considerations 295–297
  - described 471
  - /DOSSEG 474
  - /DSALLOC 475
  - /DYNAMIC 475
  - environment variable 488
  - /EXEPACK 475
  - /FARCALL 476
  - /HELP 477
  - /HIGH 477
  - /INFO 477

LINK (*continued*)options (*continued*)

/LINE 478  
/MAP 478  
/NOD 479  
/NOE 479  
/NOFARCALL 479  
/NOGROUP 480  
/NOI 480  
/NOLOGO 480  
/NONULLS 480  
/NOPACKC 481  
/NOPACKF 481  
/OLDOVERLAY 481  
/ONERROR 481  
/OV 482  
/PACKC 482  
/PACKD 483  
/PACKF 484  
/PAUSE 484  
/PCODE 485  
/PM 485  
/Q 485  
rules 471, 472  
/SEG 486  
/STACK 487  
/TINY 487  
/W 488

ordered functions 508

output files 459–460

overlays

*See also* Overlays  
creating 459  
deffile field 466  
/DYNAMIC 475  
/OLDOVERLAY 481  
/OV 482

overview 458–459

p-code 485

packaged functions 481, 484

packing

code 481–482  
data 483  
executable file 475

paragraphs 473

path 463

program size 472, 476

prompts 469, 472

public symbols 478

PWB menu commands 67

references, resolving 464–465

relocatable files 459

relocations 475–476, 479

requirements 457

LINK (*continued*)

response file 469–470, 472

return codes 490

rules for output 459

running 457, 468

segmented-executable files

*See also* Segmented-executable files

creating 459, 466

segments

aligning 472

limit 486

loading 475

ordering 474, 480

stack

/STACK option, EXEHDR 515

/STACK option, LINK 487

STACKSIZE statement 500

suppressing messages 472

syntax 460–466, 468–469, 471

system requirements 457

temporary files 489–490

Windows, programs for

*See also* Windows, programs for

creating 459, 466

LINK environment variable 488–489, 864

LINK Options command, PWB 67

Linker *See* LINK

Linking

debugging considerations 295–297

defined 864, 870

libraries, LIB 581

topics, HELPMAKE 601–603

Linsert function, PWB 98, 141, 166–167

List box, PWB 73

List files defined 865

List References command, PWB

described 68

function 134

List Watch command, CodeView 399

List Watch Expressions command, CodeView 441

Listing

.ASM files, PWB 86

breakpoints, CodeView 405

consistency check, LIB 584

cross references, LIB 590

defined 865

expression evaluators, CodeView 344

functions, CodeView 411–412

help files 680

help files, CodeView 305

mapfile, LINK 463

Microsoft Advisor topics 673

modules, CodeView 439

project files, PWB 38

Listing (*continued*)

- references, PWB 92
  - watch expressions, CodeView 339, 441
- Literal characters, searching, PWB 83
- Live expressions, creating, CodeView 331
- .LNK files defined 865
- Load command, CodeView 336–338
- Load dialog box, CodeView 337–338
- Load libraries 462, 865
- Load Other Files option, CodeView 314
- Load switch, PWB 245, 266
- Loader, Windows 498
- Loading
  - source files, CodeView 333
  - symbolic information, CodeView 314
- LOADONCALL attribute 504
- Local
  - contexts, help files, linking 603–604
  - heaps, listing memory objects, CodeView 358, 438
  - memory handles, converting to pointers 441–442
  - symbols defined 865
  - variables, listing, CodeView 328–329, 344
- Local command, CodeView 347–348
- Local Options command, CodeView 342, 344
- Local Options dialog box 344
- Local window
  - CodeView
    - function 328–329
    - opening 348
    - overview 322
  - defined 865
- LocalLock routine, locking memory handles 360
- Locking help files 597
- Log command, PWB
  - described 65
  - predefined macros 133
- Log Search Complete dialog box, PWB 80
- Logged search, PWB 78, 167, 225, 259
- Logical segment defined 865
- Logsearch function, PWB 141, 167
- Long integer defined 865
- LONGNAMES keyword, NAME statement 496
- Loops, infinite, terminating execution 362
- Low memory defined 865
- .LRF files defined 865
- .LST files defined 865
- /lu option, BCSMAKE 621
- l-value defined 865

**M**

- M option, CodeView 310
- :m command, HELPMAKE 607

## /M option

- CL, setting breakpoints 405–408
- CodeView 315
- CVPACK 633
- LINK 478
- NMAKE 527, 531
- PWB 132
- m. context prefix, HELPMAKE 613
- /MA option, EXEHDR 514
- Machine code defined 865
- Macros
  - changing key assignment, PWB 109–111, 125–126
  - debugging
    - at the source level 294
    - programming considerations 294
  - defined 865
  - defining, PWB 147–149
  - executing, PWB 96–98, 160
  - flow control statements, PWB 102–104
  - key assignments, PWB 135–140
  - overview, PWB 99
  - predefined, PWB 132–135, 207–244
  - recording, PWB 99–102, 190–191, 234–235
  - .SBR files, PWB 94
  - shortcut keys, PWB 71
  - source level debugging, workarounds 294
  - TOOLS.INI syntax, PWB 125
  - undefined, PWB 210–212
  - user input statements, PWB 104–106
- Macros (NMAKE)
  - assembler 558–559, 568
  - command 558–559, 568
  - comments 551
  - compiler 558–559, 568
  - defining 551–553
  - dependent path 542
  - dependents 555–556
  - described 550
  - displaying 531
  - environment variables 530, 561–562
  - escaped characters 551
  - extending a line 551
  - filename 555–556
  - ignoring 532
  - inference rules 564
  - inheriting 532, 557–558, 563
  - literal characters 551
  - Microsoft tools 558–559, 568
  - nesting 551, 560
  - newline character 535, 551–552, 561
  - NMAKE-supplied 554–559, 561–562, 568
  - null 551, 553–554
  - precedence rules 563
  - predefined 554, 556–559, 561–562, 568

Macros (NMAKE) (*continued*)

- preprocessing 553
- recursion 557–558, 563
- replacing strings 560–561
- rules 551–554, 560–561, 563
- substitution 560–561
- syntax 551–554, 560–561
- targets 555–556
- time stamps 555
- TOOLS.INI 552
- !UNDEF 553
- undefined 551–554, 559, 568
- using 554, 560–561

Magenta color value 254

Magic number, in file header 517

## .MAK files

*See also* Makefiles  
defined 865

MAKE macro (NMAKE) 557

MAKEDIR macro (NMAKE) 557

MAKEFILE file 529–530

## Makefiles

*See also* NMAKE

association with .PIF files 59

build process 51–52

building browser database, non-PWB projects 94–96

characters, literal 535

command files, inline 547

command modifiers

! (repeat command) 544, 555

- (ignore error) 544

@ (suppress echo) 544

## commands

comments 536

dependents 544, 546

described 543

in dependency 544

inference rules 564

inline files 547–550

macros, predefined 558–559, 568

repeating 544, 564

rules 543

wildcards 536

comments 536

customizing 52–55

debugging 530–531

defined 528

dependency *See* Dependency

dependency tree 538–539, 542, 563

## dependents

commands 544

described 542

filenames 555–556

inferred 542, 563, 569–570

Makefiles (*continued*)dependents (*continued*)

macros, predefined 555–556

paths 542

pseudotargets 541

described 535

description blocks *See* Description blocks

## directives

dot 570

preprocessing 572

error codes from commands 531, 544–545, 571

exit codes from commands 531, 544–545, 571

## filenames

dependents 546

long 537

macros 555–556

wildcards 536

inference rules *See* Inference rules

inline files 547–550

literal characters 535–536

loading, PWB 132

macros *See* Macros (NMAKE)

non-PWB 55–56

opening 131

## preprocessing

*See also* Preprocessing, makefile

error codes 545

exit codes 545

macros 553

return codes 545

suppressing builds 531–532

pseudotargets 540–541

recursion 557–558, 563

response files, inline 547

return codes from commands 531, 544–545, 571

rules 535

sample 578–579

sequence of operations 576–578

SET command 562–563

specifying 530

## targets

accumulating 539

build rules 538–542

described 538–539

filenames 555–556

keeping 571

macros, predefined 555–556

multiple description blocks 539–540

pseudotargets 540–541

time stamps *See* Time stamps

TOOLS.INI 534–535, 552, 572

wildcards 536

MAKEFLAGS macro (NMAKE) 557

.MAP files 865



- Map files defined 865
- /MAP option, LINK 478
- Mapfile, LINK 463, 478–479
- .mark command, HELPMAKE 607
- Mark file, PWB menu commands 65
- Mark function, PWB 78, 142, 167–168
- Markfile switch, PWB 112, 245, 266–267
- Marks
  - manipulating, in PWB 167–168
  - saving, in PWB 266–267
- MASM
  - and CodeView 389
  - and CodeView expression evaluators 380
  - debugging assembly language 389–392
  - Options command, PWB 67
  - radix 420–421
- Match Case command, PWB 68
- Match case, search option, CodeView 335–336
- Matches, searching, PWB 79–82
- Matching
  - characters, syntax 844
  - regular expressions 284–285, 853–854
- Math coprocessors
  - defined 865
  - displaying registers, CodeView 330
  - dumping register contents 448–449
- /MAX option, EXEHDR 514
- Maximize command
  - CodeView 347–348
  - described, PWB 69
  - predefined macros, PWB 135
- Maximize function, PWB 142, 168
- Maximizing windows, PWB 168, 226
- MAXVAL keyword, HEAPSIZ statement 500
- MC command, CodeView 398, 413–414
- MD command, CodeView 398, 414–415, 420–421
- MDC command, CodeView 415
- MDI defined 865
- ME command, CodeView 398, 416–418
  - and Restart command 412–413
  - input radix 420–421
- Medium memory model defined 865
- Megabyte defined 865
- Memory
  - allocation
    - EXEHDR 514
    - LINK 473
  - CodeView
    - comparing 413–414
    - displaying 330–332
    - dumping data 414–415
    - entering data 416–418
    - filling 418–419
    - moving data 419
- Memory (*continued*)
  - CodeView (*continued*)
    - searching 419–420
    - viewing 431–433
  - expression evaluator requirements 380
  - extended
    - defined 860
    - Keepmem switch, PWB 265
    - LINK options 486
  - format, changing 331
  - high, defined 861
  - LIB requirement 585
  - LINK requirement 486
  - loading 475, 477
  - managing, DOS 617–618
  - managing, CodeView 308
  - NMAKE, running 531
- Memory 1 command, CodeView 347–348
- Memory 2 command, CodeView 347–348
- Memory Compare command, CodeView 398, 413–414
- Memory Dump Code command, CodeView 415
- Memory Dump command, CodeView 398, 414–415, 420–421
- Memory Enter command, CodeView
  - and Restart command 412–413
  - generally 398, 416–418
  - input radix 420–421
- Memory Fill command, CodeView
  - and Restart command 412–413
  - generally 398, 418–419
- Memory handles
  - converting to pointers 439–442
  - dereferencing, CodeView 360
- Memory models defined 865
- Memory Move command, CodeView 399, 419
- Memory objects, listing, CodeView 357–358, 437–438
- Memory operators
  - CodeView 381
  - debugging assembly language 390–392
- Memory Search command, CodeView 399
- Memory Window command, CodeView 344
- Memory Window Options dialog box, CodeView 344
- Memory windows, CodeView
  - changing values 299
  - described 299
  - function 330–332
  - initializing values 299
  - opening 348
  - overview 322
  - saving addresses 317
  - specifying 431–433
- Memory-resident program defined 865
- Menu bars
  - activating, PWB 169

Menu bars (*continued*)

CodeView, overview 320  
defined 866

## Menu commands

adding, PWB 115, 117  
Browse menu, PWB 68, 134, 187  
choosing, PWB 70–71  
Data menu, CodeView 338–342  
Edit menu  
    CodeView 335–336  
    PWB 64  
executing, PWB 70–71  
File menu  
    CodeView 332–334  
    PWB 64, 132  
Help menu  
    CodeView 349  
    PWB 70, 135  
help, getting 671  
Options menu  
    CodeView 342–346  
    PWB 67  
predefined macros, PWB 132–135  
Project menu, PWB 66, 134  
Run menu  
    CodeView 336–338  
    PWB 66, 134  
Search menu, PWB 65, 133  
Window menu  
    CodeView 347  
    PWB 69, 135

## Menu items

adding, PWB Run menu 282–283  
custom, PWB 241–242  
help, getting 666  
HELPMAKE context prefix 613

Menukey function, PWB 142, 169

## Menus

Browse menu, PWB 68, 134, 187  
Calls menu, CodeView 346–347  
closing, PWB 71  
Data menu, CodeView 338–342  
Edit menu  
    CodeView 334–335  
    PWB 64, 133  
File menu  
    CodeView 332–334  
    PWB 64, 132  
Help menu  
    CodeView 349, 665  
    PWB 70, 135, 665  
menu bars, CodeView 320  
Options menu  
    CodeView 342–346

Menus (*continued*)

Options menu (*continued*)  
    PWB 67  
Project menu, PWB 66, 134  
Run menu  
    CodeView 336–338  
    PWB 66, 134, 241–242, 282–283  
Search menu  
    CodeView 335–336  
    PWB 65, 133  
Window menu  
    PWB 69, 135  
    CodeView 347  
Merge command, PWB 64  
Message classes, CodeView options 405–408  
!MESSAGE directive 572  
Message function, PWB 142, 169  
Message numbers, HELPMAKE context prefix 613  
Messages, Windows types and class 358–359  
Meta function, PWB 97–98, 142, 170  
Metacharacters, searching, PWB 83  
MF command, CodeView 398, 412–413, 418–419  
Mgrep function, PWB 142, 170–171  
Mgreplist macro, PWB 210–212  
/MI option, EXEHDR 514  
Microsoft Advisor 8  
    copying text 668  
    error help 671–672  
    global searches 674–675  
    help files  
        concatenating 680  
        listing 680  
        managing 679–681  
        opening 673  
        splitting 681  
    Help menus 665  
    help, getting 664–673  
    hyperlinks 666–668  
    index 670  
    keyword help 669, 671  
    menu items 665  
    mouse functions 665  
    pasting text 668–669  
    Pwbhelp function 185  
    structure 663  
Microsoft Browse Information Compactor *See* SBRPACK  
Microsoft Browser Database Maintenance Utility *See*  
    BSCMAKE  
Microsoft Debugging Information Compactor *See*  
    CVPACK  
Microsoft EXE File Header Utility *See* EXEHDR  
Microsoft File Expunge Utility *See* EXP  
Microsoft File Removal Utility *See* RM  
Microsoft File Undelete Utility *See* UNDEL

- Microsoft Import Library Manager *See* IMPLIB
- Microsoft Library Manager *See* LIB
- Microsoft Program Maintenance Utility *See* NMAKE
- Microsoft Relocatable Object-Module Format (OMF) 458
- Microsoft Segmented Executable Linker *See* LINK
- Microsoft Symbolic Debugging Information 473
- Microsoft Windows
  - debugging 351–357
  - default key assignments, PWB 140
- Microsoft Word, rich text format, HELPMMAKE 609
- /MIN option, EXEHDR 514
- Minimally formatted ASCII
  - HELMMAKE 600, 612
  - specifying, HELPMMAKE 597
- /MINIMUM option, CVPACK 633
- Minimize command
  - CodeView 347–348
  - PWB 69, 135
- Minimize function, PWB 142, 171
- Minimizing windows in PWB 226
- Minus sign (–) *See* Dash (–)
- Mixed mode defined 864
- ML options, debugging considerations 295–296
- Mlines function, PWB 142, 171
- MM command, CodeView 399, 419
- Mnemonics, assembling 400–402
- Mode *See* Protected mode; Real mode
- Model entry, TOOLS.INI file
  - CodeView 299–302, 305
  - debugging p-code 364
  - remote debugging 368–369
- Module Outline command, PWB
  - described 68
  - function 134
- Module-definition files
  - application name, type 495
  - attributes 503
  - case sensitivity 494
  - class, segment 502
  - code segments 501
  - comments 494, 497
  - creating 491
  - custom loader 498
  - data segments 501
  - defined 858, 864
  - DLLs 505
  - export ordinals 505
  - exporting 505
  - functions
    - exported 505
    - FUNCTIONS 508
    - imported 506
  - heap 500
  - importing 506
- Module-definition files (*continued*)
  - include file 510
  - inserting text 496
  - library name 496
  - linking 466
  - MS-DOS programs 499
  - MS-DOS stub 497
  - name of program 495–496
  - new features 491–492
  - numeric arguments 494
  - operating system 498
  - overlays 502
  - overview 492
  - private library 496
  - protected mode 499
  - PWB 38
  - real mode 500
  - reserved words 494, 510
  - segments
    - attributes 501–503
    - class 502
    - name 502
  - stack 500
  - statements
    - APPLOADER 498
    - CODE 501
    - DATA 501
    - DESCRIPTION 496
    - EXETYPE 498
    - EXPORTS 505
    - FUNCTIONS 508
    - HEAPSIZE 500
    - IMPORTS 506
    - INCLUDE 510
    - LIBRARY 496
    - NAME 495
    - OLD 505
    - PROTMODE 499
    - REALMODE 500
    - SEGMENTS 502
    - STACKSIZE 500
    - STUB 497
    - summaries 493
  - syntax rules 494
  - version 499
  - Windows, programs for
    - See also* Windows, programs for
    - EXETYPE statement 499
    - NAME statement 495
- Modules
  - configuring, CodeView 337–338
  - defined 866
  - listing, CodeView 358, 439

## Monitors

## CodeView

- black-and-white display 312
- redrawing 454
- screen exchange 313, 315, 345, 422–424, 454
- specifying 310–311
- suppressing snow 314

## line-display mode, CodeView 311

## PWB, specifying color 252, 254

## remote debugging 371

## Monochrome adapter defined 866

## Mouse

- choosing commands 70
- disabling, CodeView option 315
- enabling, PWB 267
- executing PWB commands 70–71
- help, getting 664–665
- hyperlinks, activating 667
- pointer defined 866

## Mousemode switch, PWB 245, 267

## Move command

## CodeView 347–348

## LIB 589

## PWB 69, 135

## MOVEABLE attribute

## .DEF file 504

## EXEHDR 522

## Movewindow function, PWB 142, 172

## Moving

## files

## PWB 42

## RM 654–655

## memory blocks, CodeView 419

## windows, PWB 172, 227

## Mpage function, PWB 142, 173

## Mpara function, PWB 142, 173

## MPC, debugging p-code 365

## Mreplace function, PWB 142, 173–174, 269

## Mreplaceall function, PWB 142, 174

## MS command, CodeView 419–420

## MS-DOS header format 515

## MS-DOS programs

*See also* Executable files

## creating, LINK 459

## .DEF files 491

## EXETYPE statement 499

## header

*See also* EXEHDR

## format 515

## information 516

## interrupts 482

## loading 475, 477

## memory allocation 473

## MS32EM87.DLL defined 866

## MS32KRNL.DLL defined 866

## Msearch function, PWB 142, 174–175

## Msgdialog switch, PWB 245, 268

## Msgflush switch, PWB 245, 268

## Multi-level arrays or structures, watching in CodeView 325

## Multimodule programs, PWB

## assembler options 47, 49–50

## building 40

## editing 41–42, 49

## extending projects 52–55

## non-PWB makefiles 55–56

## opening projects 36

## overview 35

## project contents 38

## project dependencies 39, 41

## using existing projects 42–43

## Multiple applications, debugging 354–357

## MULTIPLE attribute 504

## Multitasking operating system defined 866

## Mword function, PWB 142, 175

**N**

## N command, CodeView 399, 420–421

## :n command, HELPMMAKE 608

## n. context prefix, HELPMMAKE 613

## n, unsigned number, predefined expression syntax 846, 848, 853

## /N option

## CodeView 310, 314–315

## CVPACK 633

## NMAKE 531

## /n option, BSCMAKE 621

## \n, tagged expression reference, syntax 846, 849

## Name decorations, debugging considerations 296, 385–386

## NAME statement

## application type, EXEHDR 514, 523

## described 495

## name, EXEHDR 518

## Named tags, TOOLS.INI file, PWB 124

## Naming segments, debugging considerations 294

## NAN defined 866

## Native command, CodeView 342, 346, 366–367

## Native entry, TOOLS.INI file

## CodeView 299–300, 302, 305

## remote debugging 368–369

## Native execution model, specifying, CodeView 305

## Navigation

## CodeView windows 323

## cursor movement commands, PWB 144

## Microsoft Advisor 664–673

## QuickSearch 678

Navigation (*continued*)

- windows, menu commands, PWB 69
- /NE option, EXEHDR 514
- Near address defined 866
- Negated set, regular expression syntax 845
- negative numbers in expressions and H2INC 640
- Nested structures, expanding, contracting 453
- New .EXE header
  - address 521
  - format 515
  - information 521
- New command, PWB 64, 69, 132, 135
- New line, starting, PWB 158
- New Project command, PWB 66
- Newfile function, PWB 142, 175–176
- NEWFILES keyword, NAME statement 496
- /NEWFILES option, EXEHDR 514
- Newline character
  - .DEF file syntax 494
  - defined 866
  - makefile syntax 535, 551–552, 561, 564
- Newline function, PWB 142, 176
- Newwindow switch, PWB 245, 269
- .next command, HELPMMAKE 607
- Next command, PWB 64, 68, 70, 132, 135
- Next Error command, PWB 66
  - multimodule builds 40
  - predefined macros 134
- Next Match command, PWB
  - described 65
  - searching 81
- Nextmsg function, PWB 142, 177, 269
- Nextsearch function, PWB 142, 178, 269
- nfodialog switch, PWB 245
- NMAKE
  - See also* Makefiles
  - batch processing 532
  - building projects, PWB 39, 52–54
  - builds
    - conditional 572
    - errors 572
    - forcing builds 530
    - halting 572
    - ignoring errors 531, 544–545, 571
    - keeping targets 571
    - managing projects 528
    - matching time stamps 530
    - suppressing 531–532
    - targets 538
  - command file 533–534
  - command files, inline 547
  - command line 529, 533
  - command modifiers
    - ! (repeat command) 544–555

NMAKE (*continued*)

- command modifiers (*continued*)
  - (ignore error) 544
  - @ (suppress echo) 544
- commands
  - comments 536
  - dependency line 544
  - dependents 544, 546
  - described 543
  - displaying 531
  - error codes 531, 544–545, 571
  - exit codes 531, 544–545, 571
  - inference rules 564
  - inline files 547–550
  - macros, predefined 558–559, 568
  - modifiers 544
  - repeating 544, 564
  - return codes 531, 544–545, 571
  - rules 543
  - suppressing display 532, 544, 571
  - wildcards 536
- comments 534, 536, 551
- copyright message 530–531
- debugging makefiles 530–531
- dependency *See* Dependency
- dependency tree 538–539, 542, 563
- dependents
  - commands 544
  - defined 530
  - described 542
  - filenames 555–556
  - inferred 542, 563, 569–570
  - macros, predefined 555–556
  - paths 542
  - pseudotargets 541
- description blocks *See* Description blocks
- directives
  - !CMDSWITCHES 534, 572
  - !dot 570
  - ERROR 572
  - .IGNORE 571
  - !MESSAGE 572
  - .PRECIOUS 558, 571
  - preprocessing 572–575
  - .SILENT 571
  - .SUFFIXES 531–532, 546, 558, 563, 565, 568–571
  - !UNDEF 553, 563
- environment variables
  - /E option 530
  - for NMAKE 534
  - INIT 534
  - TMP 548
- error codes from commands 531, 544–545, 571

## NMAKE (continued)

- errors
  - displaying 532
  - !ERROR 572
  - suppressing 530
- extending a line
  - command 543
  - dependency 538
  - macro 551
- fields
  - macros 529
  - options 529
  - targets 529
- filenames
  - dependents 546
  - long 537
  - macros 555–556
  - wildcards 536
- forcing builds 540–541
- help 530, 532
- inference rules
  - See also* Inference rules
  - displaying 531
  - ignoring 532
  - predefined 567–568
- information
  - additional 531
  - displaying 530–531
  - !ERROR 572
  - !MESSAGE 572
  - suppressing command echo 532, 544, 571
  - suppressing messages 530
  - !UNDEF 553, 563
- INIT environment variable 534
- inline files 547–550
- input 530
- KEEP 548
- limits
  - command line 533, 547
  - macro length 551
  - target length 538, 540
- macros
  - See also* Macros (NMAKE)
  - assembler 558–559, 568
  - command 558–559, 568
  - compiler 558–559, 568
  - dependent path 542
  - described 550
  - displaying 531
  - environment variables 530, 561–562
  - filename 555–556
  - ignoring 532
  - inheriting 532, 557–558, 563
  - Microsoft tools 558–559, 568

## NMAKE (continued)

- macros (continued)
  - precedence rules 563
  - predefined 554–562, 568
  - recursion 557–558, 563
  - replacing strings 560–561
  - rules 563
  - specifying 529
  - substitution 560–561
  - syntax 535
- MAKEFILE file 529–530
- makefiles
  - See also* Makefiles
  - debugging 530–531
  - defined 528
  - described 535
  - PWB 56
  - specifying 529–530
  - standard input 530
- messages
  - displaying 530
  - !ERROR 572
  - !MESSAGE 572
  - suppressing 530
- new features 527
- NOKEEP 548
- operating system
  - requirements 527
  - time 528
- option macros 559, 568
- options
  - !CMDSWITCHES 572
  - /? 532
  - /A 530
  - /B 530
  - /C 530
  - /D 530
  - /E 530, 561, 563
  - /F 529–530
  - /HELP 530
  - /I 531
  - /K 531
  - /N 531
  - /NOLOGO 531
  - /P 531
  - /Q 532
  - rules 529
  - /R 532
  - specifying 529–530
  - /S 532
  - /T 532
  - /V 532, 563
  - /X 532

## NMAKE (continued)

output  
 additional 530–531  
 !ERROR 572  
 errors from NMAKE 532  
 preprocessing 531  
 suppressing command echo 532, 544, 571  
 suppressing messages 530  
 overview 528  
 preprocessing  
   *See also* Preprocessing, makefile  
   error codes 545  
   exit codes 545  
   macros 553  
   return codes 545  
   suppressing builds 531–532  
 pseudotargets 540–541  
 recursing 532  
 recursion 557–558, 563  
 response files, inline 547  
 return codes from commands 531, 544–545, 571  
 running 527, 529, 533–535  
 sample makefile 578–579  
 sequence of operations 576–578  
 standard input 530  
 syntax 529  
 system requirements 527  
 targets  
   accumulating 539  
   build rules 538–542  
   building all 530  
   checking timestamps 532  
   defined 528  
   described 538  
   filenames 555–556  
   keeping 571  
   macros, predefined 555–556  
   multiple description blocks 539–540  
   pseudotargets 540–541  
   specifying 529  
 time stamps  
   2-second resolution 530  
   changing 532  
   checking 532  
   defined 528  
   dependencies 528  
   displaying 530  
   macros, predefined 555  
   pseudotargets 541  
 TMP environment variable 548  
 TOOLS.INI  
   !CMDSWITCHES directive 572  
   described 534–535  
   ignoring 532

## NMAKE (continued)

TOOLS.INI (continued)  
 macros 552  
 touch 532  
 NMAKE Options command, PWB 67  
 NMDIPCD.DCC 364  
 NMWOPCD.DCC 364  
 /NO option, EXEHDR 514  
 /NOD option, LINK 479  
 NODATA keyword, EXPORTS statement 506  
 /NODEFAULTLIBRARYSEARCH option, LINK 479  
 /NOE option  
   LIB 585  
   LINK 465, 479  
 Noedit function, PWB 142, 178–179  
 NOEXE, /ONERROR option 481  
 /NOEXTDICTIONARY option, LIB 585  
 /NOEXTDICTIONARY option, LINK 465, 479  
 /NOF option, LINK 479  
 /NOFARCALL option, LINK 479  
 /NOFARCALLTRANSLATION option, LINK 479  
 /NOG option, LINK 480  
 /NOGROUP option, LINK 480  
 /NOGROUPASSOCIATION option, LINK 480  
 /NOI option  
   IMPLIB 653  
   LIB 585  
   LINK 480  
 /NOIGNORECASE option  
   IMPLIB 653  
   LIB 585  
   LINK 480  
 Noise switch, PWB 245, 270  
 NOKEEP, inline file 548  
 /NOL option  
   IMPLIB 654  
   LIB 585  
   LINK 480, 489  
 /NOLOGO option  
   BSCMAKE 621  
   CVPACK 633  
   EXEHDR 514  
   HELPMMAKE 599  
   IMPLIB 654  
   LIB 585  
   LINK 480, 489  
   NMAKE 531  
   SBRPACK 625  
 /NON option, LINK 480  
 Non-constant integer expressions and H2INC 638  
 /NONULLS option, LINK 480  
 /NONULLSDOSSEG option, LINK 480  
 Non-UNIX  
   predefined expressions syntax 846

- Non-UNIX (*continued*)
- regular expressions
    - matching method 855–856
    - syntax 847–848, 854–855
    - syntax, setting, in PWB 281–282
  - NONAME keyword, EXPORTS statement 506
  - NONAME keyword, OLD statement 505
  - NONDISCARDABLE attribute 503
  - NONE attribute 503
  - NONE keyword, STUB statement 497
  - Nonmaskable-interrupt, CodeView 314
  - Nonmaskable-Interrupt Trapping option, CodeView 315
  - Nonresident names
    - NONAME keyword, EXPORTS statement 506
    - table, EXEHDR 522
  - NONSHARED attribute 504
  - /NOP option, LINK 458
  - /NOPACKC option, LINK 481
  - /NOPACKCODE option, LINK 481
  - /NOPACKF option, LINK 481
  - /NOPACKFUNCTIONS option, LINK 481
  - NOTWINDOWCOMPAT keyword, NAME statement 495
  - NOVIO, /PM option 485
  - Null
    - bytes 474, 480
    - character defined 868
    - pointer defined 868
  - Number sign (#)
    - custom builds 53
    - HELPMMAKE syntax 596–597
    - makefile syntax 536, 551–552, 564
    - Tab Set command, CodeView 400, 445
    - TOOLS.INI syntax 534
  - Numbers, predefined expression syntax 844, 851
  - Numeric
    - constants, CodeView expression evaluators 384
    - switches, PWB 112
- O**
- O command, CodeView 399, 422–424
  - O3 command, CodeView 422–424
  - /O option
    - HELPMMAKE 596, 598
    - LINK 458
  - /o option, BSCMAKE 621
  - OA command, CodeView 321, 422–424
  - OB command, CodeView 422–424
  - .OBJ files defined 868
  - Object files
    - defined 868
    - in libraries, LIB 581
    - linking *See* LINK
    - PWB 38
  - Object module format defined 868
  - Object modules defined 868
  - Object-Module Format 458
  - OC command, CodeView 422–424
  - /Od option, ML, debugging considerations 296
  - OF command, CodeView 422–424
  - /Of option, CL, debugging p-code 365
  - /Of- option, CL, debugging p-code 365
  - Offset defined 868
  - OFFSET operator, MASM 391
  - OH command, CodeView 422–424
  - OL command, CodeView 422–424
  - /OL option, LINK 481
  - Old header format 515
  - OLD statement 505
  - OLDNAMES.LIB 479
  - /OLDOVERLAY option, LINK 481
  - OMF
    - defined 866
    - LINK object-file format 458
  - ON command, CodeView 422–424
  - /ON option, LINK 481
  - /ONERROR option, LINK 481
  - Open command, PWB 64
  - Open Custom command, PWB 68
  - Open Module command, CodeView 332–333
  - Open Module dialog box, CodeView 333
  - Open Project command, PWB 66
  - Open Source command, CodeView 332–, 333
  - Open source File dialog box, CodeView 333
  - Openfile function, PWB 142, 179, 269
  - Opening
    - files, PWB 64, 131, 179, 269
    - help files
      - Microsoft Advisor 673
      - PWB 200
      - QuickHelp 677
    - projects
      - automatically 265–266
      - PWB 36, 43–44, 183
    - source files, CodeView 333
    - Source window, CodeView 324
    - windows
      - CodeView 347
      - PWB 188, 206, 228
  - Operating system
    - EXETYPE statement 498
    - MS-DOS stub 497
    - Windows *See* Windows, programs for
    - Operating system prompt, DOS Shell command 333
  - Operating system tags, TOOLS.INI file, PWB 122
  - Operations
    - LIB *See* LIB
    - regular expressions, PWB 86



- Operators
    - flow control, PWB 102–104
    - functions, using C++ expressions 388
    - regular expressions, PWB 83–85, 87
  - Opt 315
  - Optimizing
    - assembler options, PWB 47
    - debugging considerations 296
    - far calls, LINK 476, 479, 482
    - load time 476
    - relocations, LINK 475
  - Option button, PWB 73
  - OPTION directive
    - CASEMAP 638
    - EXPR32 *See* EXPR32 argument, OPTION directive
  - Options
    - See also* specific tool
    - assembler, changing in PWB 47, 49–50
    - BSCMAKE 620–622
    - CL, debugging considerations 296
    - CodeView
      - described 310–315, 422–424
      - remote debugging 370–371
      - setting 317
    - compiler 295–296
    - CVPACK 633
    - EXEHDR 514–515
    - EXP 656
    - HELPMAKE
      - decoding 597–598
      - encoding 596–597
    - IMPLIB 653
    - in makefiles 559, 568, 572
    - LIB 584–586
    - LINK 295–297, 471–488
    - ML, debugging considerations 295–296
    - NMAKE 529–532
    - PWB 131–132
    - RM 654
    - SBRPACK 625
    - UNDEL 656
  - Options command, CodeView 399, 422–424
  - Options menu
    - CodeView 342–346
    - PWB 67
  - Ordered functions 508
  - Ordering segments 294
  - Ordinal number, export
    - EXEHDR 521
    - EXPORTS statement 506
    - OLD statement 505
  - OS command, CodeView 422–424
  - Output
    - redirecting, CodeView 450–452
  - Output (*continued*)
    - screen defined 869
    - viewing, CodeView 349
    - /Ov option, CL, debugging p-code 365
    - /Ov- option, CL 365
    - /OV option, LINK 482
    - OV command, CodeView 422–424
    - OVERLAY keyword, SEGMENTS statement 502
    - /OVERLAYINTERRUPT option, LINK 482
  - Overlays
    - creating 459, 466
    - defined 867
    - FUNCTIONS statement 509
    - interoverlay calls 475
    - interrupt number 482
    - LINK 457
    - overlay number 502
    - SEGMENTS statement 502
    - static overlays 481
  - Overloaded functions using C++ expressions 388
  - OVL keyword, SEGMENTS statement 502
- ## P
- P command, CodeView 399, 425, 428
  - :p command, HELPMAKE 607
  - \p formatting attribute, HELPMAKE 603–605
  - /P option
    - CodeView 370–371
    - CVPACK 633
    - EXEHDR 514
    - LIB 585–586
    - NMAKE 531
  - P register, CodeView syntax 395, 426
  - p, path, predefined expression syntax 846, 848, 853
  - P-code
    - debugging 346, 363–367
  - linking 485
    - defined 865
    - FUNCTIONS statement 508
    - /NOPACKF option, LINK 481
    - ordered 508
    - /PACKF option, LINK 484
  - /PACKC option, LINK 482
  - /PACKCODE option, LINK 482
  - /PACKD option, LINK 483
  - /PACKDATA option, LINK 483
  - /PACKF option, LINK
    - /PACKFUNCTIONS option, 484
    - registers, displaying 329
  - Packaged function
    - defined 867
    - LINK 484

- Packing
  - code 481–482
  - data 483
  - executable file
    - determining, EXEHDR 517
    - /EXEPACK option, LINK 475
    - iterated (segment attribute) 523
  - files, CVPACK 631–632
  - .SBR files 616, 623–624
- /PADC option, LINK 458
- /PADD option, LINK 458
- /PAGE option, LIB 585–586
- /PAGESIZE option, LIB 585–586
- \par formatting code, HELPMMAKE 610
- \pard formatting code, HELPMMAKE 610
- Parameters defined 869
- Parent process defined 869
- Parentheses (
  - balancing, in PWB 180–181
  - makefile syntax 554, 556, 560
- .PAS files defined 869
- PASCAL macro (NMAKE) 559
- .paste command, HELPMMAKE 607
- Paste command
  - CodeView 335
  - PWB
    - described 64
    - predefined macros 133
- Paste function, PWB 86, 98, 142, 179–180
- Pasting text
  - Microsoft Advisor 668
  - QuickHelp 679
- PATH environment variable
  - CodeView, installing 299
  - starting PWB 59
- Paths
  - Curfile predefined macro, PWB 210
  - defined 867
  - predefined expression syntax 846, 848, 853
- Patterns *See* Regular expressions
- /PAU option, LINK 484
- Pause command, CodeView 400, 445
- /PAUSE option, LINK 484
- Pausing Trace Speed command, CodeView 344
- Pbal function, PWB 142, 180–181
- /PC option, LINK 485
- /PCODE option, LINK 485
- .PCH files defined 869
- Percent sign (%)
  - Filename-Parts Syntax, PWB 247
  - makefile syntax 536
- Period (.)
  - Current Location command, CodeView 400, 446
  - line number specifier, CodeView 339
- Period (.) (*continued*)
  - LINK syntax 461, 466, 469
  - makefile syntax 564, 570
  - match character, syntax 844
  - wildcard character, syntax 843, 846
- /PF option, PWB 131
- PFLAGS macro (NMAKE) 559
- Physical segments defined 867
- PID defined 867
- PIF files, association with Makefiles 59
- /PL option, PWB 131
- \plain formatting code, HELPMMAKE 610
- Playback macro, PWB 210
- Plines function, PWB 142, 181
- Plus sign (+)
  - concatenating help files 680
  - LIB syntax 587–588
  - LINK syntax 461, 463, 469–470
  - makefile syntax 572
  - searching, PWB 84
- /PM option, LINK 485, 495, 514, 523
- PM, /PM option 485
- /PMTYPE option
  - EXEHDR 514
  - LINK 485, 495, 514, 523
- Pointers
  - converting global memory handles 439–440
  - converting local memory handles 441–442
  - defined 867
  - expanding and contracting, CodeView 342, 453–454
  - H2INC, translated by 642
  - null 474, 480
- .popup command, HELPMMAKE 607
- Pop-up menu defined 867
- Port defined 867
- Port Input command, CodeView 398, 410–411
- Port Output command, CodeView 399, 424
- port: option, CodeView 370
- Postfix operator, CodeView precedence 382
- Pound sign (#)
  - custom builds 53
  - HELMMAKE syntax 596–597
  - makefile syntax 536, 551–552, 564
  - Tab Set command, CodeView 400, 445
  - TOOLS.INI syntax 534
- Power, regular expression syntax 845, 853
- /PP option, PWB 131
- Ppage function, PWB 142, 181–182
- Ppara function, PWB 142, 182
- PQ register, CodeView 395, 426
- Pragmas
  - alloc\_text 509
  - comment 465
- Precedence defined 867

- .PRECIOUS directive
  - described 571
  - recursion 558
- Predefined constants
  - and H2INC 638
  - converting 660
- Predefined expressions syntax
  - non-UNIX 848
  - UNIX 846, 853
- \_ predefined macro 226
- Predefined macros, PWB 132–244
- Prefixes
  - context, HELPMMAKE 613
  - program segments, debugging considerations 295
- PRELOAD attribute 504
- Preprocessing directives, NMAKE 573–575
- Preprocessing, makefile
  - conditional 572
  - directives 572
  - error codes 545
  - errors, forcing 572
  - exit codes 545
  - halting builds 572
  - indenting 572
  - macros 553
  - return codes 545
  - suppressing builds 531–532
- .previous command, HELPMMAKE 607
- Previous command, PWB
  - described 68
  - function 135
- Previous Error command, PWB
  - described 66
  - predefined macros 134
- Previous match command, PWB
  - described 65
  - predefined macros 133
  - searching 81
- Print command
  - CodeView 332–333
  - PWB 64
- Print dialog box, CodeView 333
- Print dialog box, CodeView 333
- Print function, PWB 142, 182–183
- Print Results command, PWB 69
- Printcmd switch, PWB 245, 247, 270
- Printfile entry, TOOLS.INI file, CodeView 302, 306
- Printing
  - cancelling, \_pwbcancelprint macro 215
  - directly to a printer in CodeView 333
  - files
    - CodeView 333
    - PWB 182–183
  - specifying program, PWB 270
- Printing (*continued*)
  - to a file, CodeView 333
- PRIVATE keyword, EXPORTS statement 506
- PRIVATELIB keyword, LIBRARY statement 496
- Privileged mode defined 867
- Procedure call defined 867
- Procedure defined 867
- Process defined 867
- Process Descriptor Block command block, CodeView 357
- Process identification number, defined 867
- Program Arguments command, PWB 66
- Program build errors 23
- Program Item, adding, PWB 58
- Program Maintenance Utility *See* NMAKE
- Program segment prefixes 295
- Program Step command, CodeView
  - generally 399, 425, 428
  - controlling execution 361
- Program step defined 867
- Programs
  - building 51–52
  - debugging, preparing for 293–297
  - PWB
    - building 40
    - debugging 26
    - editing 41–42, 49
    - multimodule 35
    - non-PWB makefiles 55–56
    - project dependencies 39, 41
    - running 40–41
- Project function, PWB 142, 183
- Project menu described, PWB 66
- Project menu, predefined macros, PWB 134
- Project Templates command, PWB 67
- Projects
  - building *See* NMAKE
  - opening automatically 265–266
  - PWB
    - adding files 38–39, 41, 44
    - closing 218
    - contents 38
    - defined 35
    - deleting files 42
    - dependencies 39, 41
    - editing 41–42
    - extending 52–55
    - makefiles 51–52
    - menu commands 66
    - moving files 42
    - opening 36, 183
    - status files 129
    - using 42–43
- Prompt function, PWB 106, 142, 183–184

## Prompts

- Askexit switch, PWB 248
- Askrtm switch, PWB 249
- LIB 582–583
- LINK 469, 472

## Protected mode

- defined 855, 868
- PROTMODE statement 499

## PROTMODE statement 499

## PROTO directive generated by H2INC 648

## Prototypes converted by H2INC 648

## Psearch function, PWB 97, 142, 184–185

## Pseudofiles

- creating, in PWB 175–176, 227–228
- Saveall function, PWB 195

## Pseudotargets

- dependents 541
- described 540–541
- time stamps 541

## PTR operator, debugging assembly language 391

## Public symbols

- browser database 616
- /CO option, LINK 473
- in a library, LIB 590
- /MAP option, LINK 478
- searching, CodeView 382–384

## PURE attribute 504

## PWB

## Browse menu

- described 68
- functions 134, 187

## build errors 23

## build options 18

## closing 7

## command line 131–132

## commands

- choosing 70–71
- cursor movement 144
- executing 70–74, 132, 160, 205

## configuration

- autoloading 121–122
- environment variables 127–128
- overview 120–121

## customizing colors 114–115

## Edit menu

- described 64
- predefined macros 133

## File menu

- described 64
- predefined macros 132

## files

- adding 41, 44
- deleting 42
- estimating size 94

PWB (*continued*)files (*continued*)

- moving 42

## functions 96–98, 106, 111–112, 114, 118, 140–141, 146–206

## help

- copying and pasting 668, 679
- getting 8, 664–673
- global searches 674–675
- keywords 669
- managing files 680–681
- opening files 673
- structure 663

## Help menu 70, 135, 665

## HELPMMAKE, restrictions 593

## key assignments 135, 140

## macros

- changing key assignments 109–111, 125–126
- executing 96–98, 160
- flow control statements 102–104
- overview 99
- recording 99–102
- user input statements 104–106

## makefiles

- loading 132
- opening 131

## multimodule programs

- project dependencies 39
- using existing projects 42–43

## options 18, 131–132

## Options menu 67

## predefined macros 132–135, 207, 209–244

## programs

- adding files 38–39, 44
- assembler options 47, 49–50
- build process 22, 51–52
- building 40
- editing 41–42, 49
- extending projects 52–55
- non-PWB makefiles 55–56
- opening projects 36
- overview 35
- project contents 38
- project dependencies 41
- running 25, 40–41

## project file list 38

## Project menu 66, 134

## prompt

- Askexit switch 248
- Askrtm switch 249

## quitting 41, 160–161, 233–234

## regular expressions syntax 281–282

## Run menu

- adding commands 115, 117

- PWB (*continued*)
- Run menu (*continued*)
    - described 66
    - predefined macros 134
  - Search menu
    - described 65
    - predefined macros 133
  - searching
    - find command 79–82
    - mark function 78
    - overview 77
    - regular expressions 82–84
  - single-module programs, building 18
  - single-module programs, debugging 26
  - source browser
    - browser database 55
    - building database 92
    - call tree, showing 91–92
    - combined database 96
    - creating database 89–90
    - estimating file size 94
    - finding symbols 90, 92–93
    - non-PWB project database 94–96
    - Pwbrowse functions 187
  - starting 57–59
  - status files 128–129
  - switches 112–114, 244, 247–275, 277, 279, 280–290
  - syntax 131–132, 247–248
  - undefined macros 210–212
  - View menu 678
  - Window menutabs 118–119, 123
  - text, replacing 85–88
  - TOOLS.INI file
    - line continuation 126
    - macros 103–105
    - switch syntax 126
    - tags 122–124
  - tutorial 7
    - described 69
    - predefined macros 135
  - \_pwb predefined macro 207
  - PWB Windows command, PWB 69
  - \_pwbarrange predefined macro 207, 212
  - \_pwbboxmode predefined macro 207, 213–214
  - \_pwbbuild predefined macro 207, 214
  - Pwbcancelbuild predefined macro 214–215
  - \_pwbcancelbuild predefined macro 207
  - \_pwbcancelprint predefined macro 207, 215
  - \_pwbcancelsearch predefined macro 215–216
  - \_pwbcascade predefined macro 207, 216
  - \_pwbclear predefined macro 207, 216–217
  - \_pwbclose predefined macro 207
  - \_pwbcloseall predefined macro 207, 217
  - \_pwbclosefile predefined macro 207, 217–218
  - \_pwbcloseproject predefined macro 207, 218
  - \_pwbcompile predefined macro 207, 218–219
  - \_pwbfilen predefined macro 207
  - \_pwbgotomatch predefined macro 207, 219
  - Pwbhelp function 142, 185
  - \_pwbhelp\_again predefined macro 207, 220
  - \_pwbhelp\_back predefined macro 207, 221
  - \_pwbhelp\_contents predefined macro 207, 221
  - \_pwbhelp\_context predefined macro 207, 222
  - \_pwbhelp\_general predefined macro 207, 223
  - \_pwbhelp\_index predefined macro 207, 223–224
  - Pwbhelpnext function 143, 186
  - \_pwbhelpnl predefined macro 207
  - \_pwbhelpnl predefined macro 219–220
  - Pwbhelpsearch function 143, 186–187
  - \_pwbhelp\_searchres predefined macro 207, 224
  - \_pwblinemode predefined macro 207, 224–225
  - \_pwblogsearch predefined macro 207, 225
  - \_pwbmaximize predefined macro 207, 226
  - \_pwbminimize predefined macro 209
  - \_pwbmove predefined macro 209, 227
  - \_pwbnewfile predefined macro 209, 227–228
  - \_pwbnewwindow predefined macro 209, 228
  - \_pwbnextfile predefined macro 209, 229
  - \_pwbnextlogmatch predefined macro 209, 229–230
  - \_pwbnextmatch predefined macro 209, 230
  - \_pwbnextmsg predefined macro 209, 231
  - \_pwbpreviouslogmatch predefined macro 209, 231
  - \_pwbpreviousmatch predefined macro 209, 232
  - \_pwbprevmsg predefined macro 209, 232–233
  - \_pwbprevwindow predefined macro 209, 233
  - \_pwbquit predefined macro 209, 233–234
  - \_pwbrebuild predefined macro 209, 234
  - \_pwbrecord predefined macro 209, 234–235
  - \_pwbredo predefined macro 209, 235–236
  - \_pwbrepeat predefined macro 209
  - \_pwbresize predefined macro 209, 236–237
  - \_pwbrestore predefined macro 209, 237
  - PWBRMAKE.EXE 615
  - Pwbrowseviewrel function 143
  - Pwbrowse1stdef function 143, 187
  - Pwbrowse1stref function 143, 187
  - Pwbrowsecalltree function 143, 187
  - Pwbrowseclhier function 143, 187
  - Pwbrowsecltree function 143, 187
  - Pwbrowsefuhier function 143, 187
  - Pwbrowsegotodef function 143, 187
  - Pwbrowsegotoref function 143, 187
  - Pwbrowselistref function 143, 187
  - Pwbrowsenext function 143, 187
  - Pwbrowseoutline function 143, 187
  - Pwbrowsepop function 143, 187
  - Pwbrowseprev function 143, 187
  - Pwbrowseviewrel function 187

Pwbrowsehref function 143, 187  
 \_pwbsaveall predefined macro 209, 237–238  
 \_pwbsavefile predefined macro 209, 238  
 \_pwbsetmsg predefined macro 209, 238  
 \_pwbshell predefined macro 209, 239  
 \_pwbstreammode predefined macro 209, 239–240  
 \_pwbtile predefined macro 209, 240  
 \_pwbundo predefined macro 209, 241  
 \_pwbusern predefined macro 209, 241  
 PWBUTILS, PWB Options menu 67  
 \_pwbviewbuildresults predefined macro 209, 242  
 \_pwbviewsearchresults predefined macro 209, 243  
 Pwbwindow function 143, 188  
 \_pwbwindow predefined macro 244  
 \_pwbwindowdown predefined macro 209  
 Pword function, PWB 143, 188

## Q

Q command, CodeView 399, 425  
 /Q option  
   EXP 656  
   LINK 485  
   NMAKE 532  
 q, quoted string, predefined expression syntax 846, 848, 853  
 QH command, MS-DOS 676  
 .QLB files defined 868  
 Qreplace function, PWB 143, 189  
 Question mark (?)  
   call tree, PWB 91  
   decorated names, C++ 385–386  
   Display Expression command, CodeView 400, 452–453  
   makefile syntax 555–556  
   Quick Watch command, CodeView 400, 453–454  
   wildcard character  
     regular expression syntax 847, 848, 850, 855  
     UNDEL 655  
   wildcard operator, HELPMAKE syntax 595  
   wildcards 536  
 Quick Watch command, CodeView 338, 342, 400, 453–454  
 Quick Watch dialog box  
   CodeView  
     described 342  
     displaying 453–454  
     exploring watch expressions 299  
 QuickHelp  
   commands 678  
   copying text 679  
   CVPACK option 633  
   EXP option 656  
   help files, opening, closing 677  
 QuickHelp (*continued*)  
   /HELP option 676  
   HELPMAKE option 599  
   IMPLIB option 653  
   pasting text 679  
   QH command, MS-DOS 676  
   specifying format, HELPMAKE 597  
   topics  
     displaying 677  
     navigation 678  
     selecting 670  
   UNDEL option 656  
 QuickHelp format  
   defining topics 600–601  
   described, HELPMAKE 599  
   dot commands 605–606, 608  
   formatting attributes 602–605  
   global contexts 603–604  
   linking topics 601–603  
   local contexts 603–604  
 /QUICKLIBRARY option, LINK 485  
 Quit command, CodeView 399, 425  
 Quitting  
   CodeView 334  
   PWB 41, 160–161, 234  
 Quotation marks, double (")  
   character strings 857  
   CodeView syntax 312–313  
   .DEF file syntax 494  
   LINK syntax 461  
   makefile syntax 537, 553  
   Pause command, CodeView 400, 445  
 Quotation marks, single (') , LINK syntax 461  
 Quote function, PWB 143, 190  
 Quoted string, predefined expression syntax 846, 848, 853

## R

R command, CodeView 399  
 :r command, HELPMAKE 607  
 /R option  
   CodeView 371  
   EXEHDR 515  
   EXP 656  
   NMAKE 532  
   PWB 132  
   RM 655  
 /r option  
   BSCMAKE 621  
   LINK 458  
 Radix  
   changing in CodeView 420–421  
   CodeView expression evaluators 384  
   defined 868

- Radix command, CodeView 399, 420–421
- RAM defined 868
- Random access memory defined 866
- rate option, CodeView 370
- .RC files defined 868
- RC macro (NMAKE) 559
- RC.HLP file 679
- RCVCOM option, CodeView 370–371
- RCVCOM.EXE file, remote debugging 370
- RCVWCOM option, CodeView 370–371
- Read Only command, PWB 64
- READONLY attribute 504
- Readonly switch, PWB 112, 245, 247, 270–271
- READWRITE attribute 504
- Real mode
  - defined 868
  - REALMODE statement 499–500
- REALMODE statement 500
- Realtabs switch, PWB 245, 271
- Realtabs switch, white space, PWB 118–119
- Rebuild All command, predefined macros, PWB 134
- Rebuilding, \_pwbrebuild macro 234
- Record function, PWB 143, 190–191
- Record On command, PWB
  - described 64
  - predefined macros 133
- Record Results, PWB 69
- Recording macros, PWB 99–102, 190–191, 234–235
- Records generated by H2INC 645
- Recursion, makefile
  - described 557–558
  - macros 557, 563
  - /V option, NMAKE 532
- Red color value 254
- Redirect Input and Output command, CodeView 400, 452
- Redirect Input command, CodeView 312–313, 450
- Redirect Output command, CodeView 312–313, 400, 450–451
- Redirection defined 868
- Redo command, PWB 64, 133
- Redraw command, CodeView 400, 454
- .ref command, HELPMMAKE 607
- Refresh function, PWB 143, 191
- Register command, CodeView 347–348, 366–367, 399
- Register indirection, debugging assembly language 391
- Register names, CodeView recognition 377, 395
- Register window
  - CodeView
    - debugging p-code 366–367
    - described 299
    - function 329–330
    - opening 348
    - overview 322
  - defined 868
- Registers
  - changing values, CodeView 426–428
  - CodeView expressions 377, 395
  - defined 868
  - display radix 420–421
  - displaying value, CodeView 329–330
  - flags, defined 862
  - math coprocessors, dumping 448–449
- Regular expressions
  - defined 868
  - finding, CodeView 335–336
  - global searches, in Microsoft Advisor 674
  - matching
    - non-UNIX 854–855
    - PWB 284–285
  - predefined *See* Predefined expressions
  - replacing text, PWB 85–88
  - searching for, CodeView 447–448
  - searching, PWB 77, 82–84
  - syntax
    - CodeView 847
    - non-UNIX 847–848, 854–855
    - PWB 84
    - UNIX 845–846, 848–849
  - tagged *See* Tagged expressions
- Relocatable defined 868
- Relocatable Object-Module Format, LINK 458
- Relocations
  - descriptions, EXEHDR 523
  - EXEHDR 630
  - far calls 476, 479
  - number, EXEHDR 517, 524
  - optimizing, LINK 475
  - table offset, EXEHDR 518
- relocs (segment attribute) 523
- Remote debugging
  - bit rate 370
  - options 370–371
  - overview 367
  - requirements 368–370
  - starting a session 371–373
  - syntax 370
  - with Windows-based target files 370
- Remove Custom Project Templates command, PWB 67
- Removing
  - breakpoints, CodeView 341–342
  - status bar, CodeView 321
- Repeat
  - command, PWB 64, 133
  - function, PWB 143, 192
  - regular expression syntax 845–849, 854–855
- Repeat Last Find command, CodeView 335–336
- Repeating function actions in PWB 262

Replace command  
LIB 589  
PWB 65

Replace function, PWB 143, 192–193

Replacing text  
Mreplace function, PWB 173–174  
Mreplaceall function, PWB 174  
Qreplace function, PWB 189  
Replace function, PWB 192–193

.RES files defined 868

Reserved words  
.DEF files 494, 510  
in MS-DOS header 521

Resetting  
CodeView command 412–413  
PWB 131

Resident names  
RESIDENTNAME keyword, EXPORTS statement 506  
table, EXEHDR 522

Resident option, CodeView 371

RESIDENTNAME keyword, EXPORTS statement 506

Resize function, PWB 143

Resizing windows, PWB 236–237

Resource-assembler source file, PWB 38

Response files  
*See also* Command files  
BSCMAKE 622  
defined 868  
inline, in makefiles 547  
LIB 583  
LINK 469–470

/RESERERROR option, EXEHDR 515

Restart command, CodeView 336–337, 398, 412–413

Restart macro, PWB 210, 212

Restcur function, PWB 143, 194

Restore command  
CodeView 347–348  
PWB  
described 69  
predefined macros 135

Restorelayout switch, PWB 245, 272

Restoring  
files, UNDEL 655  
status bar, CodeView 321  
windows, PWB 237

Return codes  
BSCMAKE 623  
CVPACK 633  
defined 861  
LIB 592  
LINK 490  
makefiles 531, 544–545, 571  
NMAKE 580

Return codes (*continued*)  
described 600, 609  
encoding 611  
formatting codes 610  
specifying 597

Right function, PWB 143, 195

RM  
command line 654–655  
options 654  
overview 631, 654  
SBRPACK 626

RFLAGS macro (NMAKE) 559  
Rich text format, HELPMMAKE  
syntax 654–655

Rmargin switch, PWB 245, 272

RND.ASM sample program 14

ROM defined 868

Root defined 868

Routines  
defined 869  
listing in CodeView 346–347

.RSP files defined 869

RTF *See* Rich text format, HELPMMAKE

Rules, inference *See* Inference rules

Run DOS Command command, PWB 66

Run menu  
CodeView 336–338  
PWB  
adding menu items 115, 117, 282–283  
custom items 241–242  
described 66  
predefined macros 134

Run OS/2 Command command, PWB 66

Run-time error defined 869

Running programs, PWB 40–41

## S

S option, CodeView 310

/S option  
BSCMAKE 621  
CodeView 313, 315  
EXEHDR 515  
NMAKE 532

Sample programs  
ONEOF.ASM 11  
PWB, SHOW 35–36, 38–43, 47, 49–50, 52–56, 89–93  
RND.ASM 14

Save All command, PWB 64, 132

Save As command, PWB 64

Save command, PWB  
described 64  
predefined macros 132



- Save Custom Project Template command, PWB 67
- Saveall function, PWB 143, 195
- Savecur function, PWB 143, 195–196
- Savescreen switch, PWB 245, 273
- Saving
  - CodeView environment 334
  - files
    - Autosave switch, PWB 250
    - PWB 64, 195, 237–238, 279
  - macros, PWB 102
  - marks, PWB 266–267
- .SBR file 616
- .SBR files
  - building browser database
    - non-PWB 95
    - PWB 89–90
  - defined 869
  - estimating size 94
- SBRPACK
  - See also* Browser database; BSCMAKE
  - and CL 616
  - command line 624
  - copyright message 625
  - creating .SBR files 616
  - error codes 626
  - exit codes 626
  - fatal errors 626
  - help 625
  - include files, excluding 624
  - operating system 624
  - options 625
  - overview 615–616, 623–624
  - return codes 626
  - rules 624
  - running requirements 624
  - .SBR file 616
  - syntax 624–625
  - system requirements 624
- Scope
  - defined 869
  - specifying, searching for symbols 443
- Scope operator (::), CodeView precedence 382
- Screen exchange
  - CodeView options 313, 315, 345, 422–424
  - defined 869
- Screen Exchange command, CodeView 400, 454
- Screen Swap command, CodeView 342, 345
- Scroll bars
  - CodeView
    - options 422–424
    - toggling options 345
  - PWB, window styles 207, 256
- Scrolling
  - defined 869
- Scrolling (*continued*)
  - Mlines function, PWB 171
  - Plines function 181
  - switches, PWB 264
  - Vscroll switch, PWB 284
- Sdelete function, PWB 143, 196
- /SE option, LINK 486
- Search command
  - CodeView 400, 447–448
  - QuickHelp 677
- Search logging, PWB 167, 225
- Search Memory command, CodeView 419–420
- Search menu
  - CodeView 335–336
  - PWB
    - described 65
    - predefined macros 133
- Search Results command, PWB
  - described 69–70
  - predefined macros 135
- Search Results dialog box, PWB 81
- Search Results window
  - PWB
    - clearing 152
    - described 243
    - Mgrep function 170–171
    - Nextsearch function 178
- Searchall function, PWB 143, 196–197
- Searchdialog switch, PWB 246, 273
- Searchflush switch, PWB 246, 274
- Searching
  - backwards, PWB 174–175
  - cancelling
    - \_pwbcascade macro 215–216
    - PWB 151
  - Find command, PWB 79–82
  - global, Microsoft Advisor 674–675
  - help system, in PWB 186–187
  - highlighting search strings, PWB 196–197
  - in CodeView, overview 335–336
  - logging searches in PWB 167, 225, 259
  - mark function, PWB 78
  - memory, CodeView 419–420
  - Mgrep function, PWB 170–171
  - Mgreplist macro, PWB 211–212
  - overview, PWB 77
  - regular expressions
    - CodeView 447–448
    - PWB 82–84
  - symbol definitions, PWB 90–93
  - symbols, CodeView 382–384, 397–398, 443
  - text, PWB 184–185
- Searchwrap switch, PWB 246, 274
- Section tags, TOOLS.INI file, PWB 122

- /SEG option, LINK 486
- Segmented-executable files
  - creating, LINK 459, 466
  - defined 869
  - header *See* EXEHDR
  - header format 515
  - MS-DOS stub 497
- Segmented-executable Linker *See* LINK
- Segments
  - aligning 472
  - attributes
    - code segments 501
    - data segments 501
    - EXEHDR 519–520, 523
    - keywords 503
    - SEGMENTS statement 502
  - class 502
  - code *See* Code segments
  - data *See* Data segments
  - defined 869
  - definitions 502
  - discardable 503
  - functions
    - assigning 508
    - explicit allocation 509
    - ordered 508
  - information 477–478
  - limit 483, 486, 502
  - listing 463
  - loading 504
  - moving 504
  - name 502
  - null bytes 474, 480
  - ordering 294, 474, 480
  - overlays 502
  - packing
    - code 481–482
    - data 483
  - permissions 503–504
  - sharing 503–504
  - table, EXEHDR 520, 522–523
- /SEGMENTS option, LINK 486
- SEGMENTS statement described 502
- Selcur function, PWB 143, 197
- Select function, PWB 144, 197
- Select To Anchor command, PWB
  - described 64
  - predefined macros 133
- Selected Text command, CodeView 336
- Selected text command, CodeView 335
- Selecting in PWB
  - selection mode 198, 224–225, 239–240, 259
  - text 197
  - windows 198
- Selection modes, PWB
  - changing 198, 224–225, 239–240, 259
  - setting 64
- Selmode function, PWB 144, 198
- Selwindow function, PWB 144, 198
- Semaphores defined 869
- Semicolon (;)
  - command separator, CodeView 312–313, 326–327
  - comments, PWB 126, 127
  - .DEF file syntax 494
  - LIB syntax 582–584
  - LINK syntax 461, 467, 469–470
  - makefile syntax 542, 544, 564
  - TOOLS.INI file syntax 301, 534
  - Separator, custom
    - predefined macros 133
- Set Breakpoint command, CodeView
  - described 338–341
  - line numbers 376
- Set Breakpoint dialog box, CodeView 339–341
- SET command, environment variables 562–563
- Set Line-Display Mode option, CodeView 53
- Sequence, NMAKE operations 576–578
- Sessions
  - defined 858
  - remote debugging, starting 371–373
- Set Anchor command, PWB
  - described 64
  - predefined macros 133
- Set Mark File command, PWB 65
- Set Project Templates command, PWB 67
- Set Record command, PWB 64
- Set Runtime Arguments command, CodeView 336–337
- Set Screen Swapping option, CodeView 315
- Set Screen-Exchange Method option, CodeView 313, 422–424
- Set Switch function, changing settings, PWB 114
- Setfile function, PWB 144, 199, 269
- Sethelp function, PWB 144, 200, 673
- SETUP program
  - CodeView, installing 299–301
  - help files, installing 679
- Setwindow function, PWB 144, 200
- SHARED attribute 504
- Shell Escape command, CodeView 399, 443–445
- Shell function, PWB 144, 201
- Shells
  - defined 869
  - DOS Shell command 333
- Shortcut keys
  - CodeView 320–321
  - PWB 71
- Shortnames switch, PWB 246, 275

- SHOW sample program, PWB 35–36, 38–43, 47, 49–50, 52–56, 89–93
- Showing call tree, PWB 91–92
- SI register, CodeView syntax 395, 426
- Sign-on banner *See* /NOLOGO option
- .SILENT directive 571
- SINGLE attribute 503
- Single precision defined 869
- Sinsert function, PWB 144, 201–202
- Size command, CodeView 347–348
- Size command, PWB  
described 69  
predefined macros 135
- Slash (/)  
EXEHDR syntax 514  
HELPMMAKE options 595  
LIB syntax 584  
LINK syntax 471  
NMAKE syntax 529  
Search command, CodeView 335–336, 400, 447–448
- Slow motion, CodeView execution 337, 344
- Small memory model defined 869
- SMARTDRV.SYS defined 869
- /Sn option, HELPMMAKE 597
- Snow, suppressing, CodeView option 314
- Softer switch, PWB 246, 275
- Source 92
- Source 1 command, CodeView 347–348
- Source 2 command, CodeView 347–348
- Source browser  
*See also* Browser database; BSCMAKE  
browser database, PWB  
building 92–93, 96  
case sensitivity 286  
combined 96  
creating 89–90  
estimating file size 94  
finding symbols 93  
makefiles 55  
non-PWB projects 94–96  
specifying 287  
makefiles, PWB 55  
menu commands, PWB 68  
Pwbrowse functions 187  
searching, PWB 78  
switches 286–287
- Source code, displaying, CodeView 324, 433–436
- .source command, HELPMMAKE 608
- Source files  
decoding, HELPMMAKE 597–598  
defined 869  
HELPMMAKE formats  
minimally formatted ASCII 612  
QuickHelp 599–608
- Source files (*continued*)  
HELPMMAKE formats (*continued*)  
rich text format 609–610  
loading, CodeView 333  
opening, CodeView 333  
PWB project file list 38  
specifying type, HELPMMAKE 597
- Source mode defined 869
- Source window  
CodeView  
arranging display 299  
displaying 433–436  
function 324  
getting help 664  
opening 348  
overview 321–322  
setting mode 429–430  
options and view source (VS) command 343
- Source1 Window command, CodeView 342
- Source2 Window command, CodeView 342
- SP register, CodeView syntax 395, 426
- Space  
inserting, PWB 201–202  
optimizing, PWB 47
- Spaces  
CodeView expression evaluators 382  
.DEF file syntax 494  
LINK syntax 461, 463, 469  
makefile syntax 551–552, 560, 564–565, 570  
trailing, display mode 279–280
- Specifiers  
CodeView Options command 422–424  
displaying source code 433–436  
memory format  
dumping memory 414–415  
entering data 416–418  
viewing memory 431–433  
scope, searching for symbols 443
- Specify Interrupt Trapping option, CodeView 314
- Specifying  
color, PWB display 252, 254  
execution model, CodeView 305  
expression evaluators, CodeView 303  
file type, HELPMMAKE 597  
filename, HELPMMAKE 596, 598  
interrupt trapping, CodeView 314  
symbol handlers, CodeView 306
- Speed of execution  
CodeView 429  
PWB switches 261, 263
- Splitting help files 681
- SS register, CodeView syntax 395, 426
- /ST option, LINK 487

- Stack
  - address 517–518
  - defined 869
  - frame defined 869
  - machine, debugging p-code 363
  - setting
    - .DEF file 500
    - /STACK option, EXEHDR 515
    - /STACK option, LINK 487
  - size, EXEHDR 518
  - trace defined 869
- /STACK option
  - EXEHDR 515
  - LINK 487
- Stack Trace command, CodeView 398, 411–412
- STACKSIZE statement 500
- Standard
  - error, defined 870
  - input, defined 870
  - library, defined 870
  - mode, defined 870
  - output, defined 870
- Starting PWB
  - command line 57–58
  - Windows Program Manager 58
- Startup
  - code defined 870
  - files, PWB configuration 127
- STARTUP.CMD, PWB configuration 127
- State file, CodeView
  - overview 316–317
  - toggleing status 315
- Statefile read entry, TOOLS.INI file, CodeView 302, 306, 315
- Statements
  - .DEF file *See* Module-definition files
  - flow control, PWB 102–104
  - multiple, debugging 294
  - TOOLS.INI syntax, PWB 124–126
  - user input, PWB 104–106
- Static
  - library defined 870
  - linking defined 870
- Status Bar
  - overview, CodeView 321
  - showing, CodeView option 422–424
- Status bar defined 870
- Status Bar command, CodeView 342, 345
- Status files, PWB 128–129
- Stream Mode command, PWB 64, 133
- Stream selection mode, setting in PWB 239–240
- String literals, CodeView expression evaluators 385
- String literals, CodeView expression operators 385
- Strings
  - CodeView expression evaluators 385
  - debugging assembly language 392
  - defined 870
  - null terminated
    - viewing in memory window 392
    - viewing with memory dump ASCII (MDA) command 392
  - searching, PWB 77–82
- Structure member defined 870
- Structures
  - debugging assembly language 392
  - defined 870
  - expanding and contracting, CodeView 342, 453–454
  - H2INC, generated by 643
  - nested, expanding and contracting 453
- Stub file defined 870
- STUB statement
  - described 497
  - EXETYPE statement interaction 498–499
- Subdirectories, copying file to, PWB 87
- Subroutine defined 870
- .SUFFIXES directive
  - dependents 546
  - described 571
  - inference rules 563, 568, 570
  - inferred dependents 569
  - /P option, NMAKE 531
  - priority 564–565
  - /R option 532
  - recursion 558
- Suppress Snow option, CodeView 314
- Swapping
  - defined 870
  - screen exchange, CodeView 313, 315, 345, 422–424
- Switches
  - PWB 83, 112–114, 118–119, 244, 247–275, 277, 279, 280–282, 284–290
  - syntax, TOOLS.INI file, PWB 126
- Switching, Window function, PWB 206
- Symbol handler, specifying, CodeView 306
- Symbolhandler entry, TOOLS.INI file
  - CodeView 299–300, 302, 306–307
  - remote debugging 368–369
- Symbolic Debugging Information 473
  - compressing 296–297
  - defined 295, 870
  - loading 314
  - memory requirements 296
  - preserving, with CVPACK 633
  - searching 336
- Symbolic information *See* Symbolic Debugging Information

## Symbols

defined 90–93, 857–858, 863  
 format, CodeView 385–386  
 .SBR files, PWB 94  
 searching for, CodeView 397–398, 443  
 searching order with C, C++ expression evaluators 382

## Syntax

*See also* specific tool, command, or statement

## CodeView

command line 308–316  
 commands 357–360  
 context operator 382–384, 397–398  
 expressions 376–379, 394, 395–397  
 regular expressions 844  
 TOOLS.INI file entries 302–308

## CVPACK 632

## EXP 656

Filename-Parts Syntax, PWB switches 247

## HELPMAKE 599

decoding 597–598  
 encoding 595–597  
 overview 595

## IMPLIB 653

macros, TOOLS.INI file, PWB 125

## non-UNIX

predefined expressions 846  
 regular expressions 845–846, 852–853

## PWB

Boolean switches 248  
 options 131–132  
 regular expressions 84, 281–282

remote debugging 370

## RM 654–655

## TOOLS.INI file

switches, PWB 126  
 tags, PWB 122, 124

## UNDEL 655

## UNIX

predefined expressions 846, 848, 853  
 regular expressions 845–846, 848–849

.SYS files defined 870

SYSTEM environment variable defined 870

System include files, finding symbols, PWB 92

## T

T command, CodeView 399, 408, 428–429

## /T option

HELPMAKE 597–598, 605  
 LINK 487  
 NMAKE 532  
 PWB 132

\tab formatting code, HELPMAKE 610

Tab function, PWB 118, 144, 202

Tab Set command, CodeView 400, 445

Tabalign switch, PWB 118–119, 246, 276

Tabdisp switch, PWB 118, 246, 276

## Tabs

.DEF file syntax 494  
 HELPMAKE syntax 595  
 hyperlinks, navigating with 666–668  
 makefile syntax 551–552, 564–565, 570  
 PWB 118–119, 123, 126, 149, 262, 271, 276–277  
 regular expressions, PWB 85  
 setting, CodeView 445

Tabstops switch, PWB 113, 118, 246, 277

## Tagged expressions

Build:message switch 852  
 justifying 852  
 overview 840–851  
 regular expression syntax 845–848, 853–855  
 replacing text, PWB 85–88

Tags, TOOLS.INI file, PWB 122–124, 301

## Targets

accumulating 539  
 build rules 538–542  
 checking timestamps 532  
 compiling, PWB 153–154  
 defined 528  
 described 538  
 filenames 555–556  
 forcing builds 530, 540–541  
 function, PWB 52–55  
 keeping 571  
 length limit 538, 540  
 macros, predefined 555–556  
 makefiles, PWB 56  
 multiple description blocks 539–540  
 pseudotargets 540–541

Tell dialog box, PWB 202–204

Tell function, PWB 98, 112, 144, 202–204

TEMP environment variable defined 871

## Temporary files

defined 871  
 LINK 489–490

## Terminate-and-stay-resident programs

defined 871  
 DOS Shell command 333  
 Shell function, PWB 201

Terminating CodeView execution 362

Ternary operator defined 871

## Text

Arg function, PWB 96–98  
 argument, Arg function, PWB 96–98  
 box, PWB 73  
 copying  
 CodeView commands 327–328

Text (*continued*)

- copying (*continued*)
    - Microsoft Advisor 668
    - QuickHelp 679
  - defined 871
  - deleting, PWB 156, 216–217
  - editing menu commands, PWB 64
  - files *See* Files
  - finding, PWB 83–85
  - formatting, HELPMMAKE topics 604–605
  - indenting, PWB 275
  - pasting
    - Microsoft Advisor 668
    - QuickHelp 679
  - replacing
    - PWB 85–88
    - Qreplace function, PWB 189
    - Replace function, PWB 192–193
  - searching, PWB 77–82, 184–185
  - selecting, PWB 197
  - strings, searching, PWB 77–82
  - switches, PWB 112
- Text Argument dialog box, PWB
- default key assignments 139
  - Lasttext function 164–165
  - Prompt function 183, 184
- TEXTEQU directive generated by H2INC 638
- TH register, CodeView syntax 395, 426
- Thread defined 871
- Thread ID defined 871
- Thread of execution defined 871
- Thunk defined 871
- Tilde (~) menu command, PWB 116
- Tile command
- CodeView 347–348
  - PWB
    - described 69
    - predefined macros 135
- Tilemode switch, PWB 246, 278
- Tiling windows, PWB 240, 278
- Time
- current, PWB 156
  - stamps
    - 2-second resolution 530
    - changing, NMAKE 532
    - checking 532
    - checking targets 531
    - defined 528, 871
    - dependency 538
    - displaying, NMAKE 530
    - macros, NMAKE 555
    - pseudotargets 541
- Timersave switch, PWB 246, 279
- Tiny memory model defined 871
- /TINY option, LINK 487
- TL register, CodeView syntax 395, 426
- .TMP files defined 871
- TMP environment variable 490, 548
- defined 871
  - starting PWB 59
- Tmpsav switch, PWB 246, 279
- Toggle State-File Reading option, CodeView 315
- Toggling defined 871
- TOOLS.INI file
- CodeView
    - configuring 301
    - entries 302–308
    - installing 299–301
    - remote debugging 368–369
    - setting options 317
  - comments 534
  - defined 871
  - makefiles 534–535, 552, 572
  - PWB
    - autoloading extensions 121–122
    - comments 126–127
    - extension switches 246
    - filename-extension tags 123
    - Initialize function 162
    - line continuation 126
    - macros 103–105
    - named tags 124
    - operating-system tags 122
    - sections tags 122
    - switch syntax 126
- TOOLS.PRE file, installing, CodeView 299–300
- .topic command, HELPMMAKE 608
- Topic command
- CodeView 349
  - PWB 70, 135
- Topic lists, Microsoft Advisor 673
- Topic: command described, PWB 665
- Topics, help files, linking 600–603
- Touch (time stamps), NMAKE 532
- Trace command, CodeView 361, 399, 428
- Trace speed command, CodeView 342, 344, 399, 408, 429
- Tracepoint defined 871
- Tracing
- defined 871
  - functions, CodeView 428
- Traildisp switch, PWB 246, 279
- Trailing
- lines, display mode, in PWB 280
  - spaces, display mode, in PWB 279–280
- Trailines switch, PWB 246, 280
- Traillinesdisp switch, PWB 246, 280
- Trailspace switch, PWB 246, 280

Translating white space, PWB 119  
 Transport entry, TOOLS.INI file  
   CodeView 299–302, 307–308  
   remote debugging 368–369  
 Transport layer, specifying, CodeView 307–308  
 Trapping, interrupting, CodeView 314  
 TSF option, CodeView 310  
 /TSF option, CodeView 315  
 TSR  
   defined 871  
   programs *See* Terminate-and-stay resident programs  
 Tutorial  
   conventions 5  
   PWB 7  
 Twips, defined 611  
 .TXT files defined 871  
 Type casting defined 871  
 TYPEDEF directive generated by H2INC 647, 649

## U

U command, CodeView 399, 429–430  
 \u formatting attribute, HELPMMAKE 604–605  
 \ul formatting code, HELPMMAKE 610  
 Unary operators  
   CodeView precedence 382  
   defined 871  
   preprocessing directives, NMAKE 574  
 Unassemble command, CodeView 399, 429–430  
 Unassembling  
   defined 858, 871  
   p-code 367  
 Unassigned function, PWB 144, 204  
 !UNDEF directive  
   macros 553  
   precedence rules 563  
 !UNDEF preprocessing directive, NMAKE 573  
 Undefined macros, PWB 210  
 UNDEL  
   command line 655  
   options 656  
   overview 631, 654  
   syntax 655  
 Undelcount switch, PWB 246, 281  
 Underlining, HELPMMAKE code 610  
 Underscore (\_), symbol format, CodeView 385–386  
 Undo command  
   CodeView 334  
   PWB  
     described 64  
     predefined macros 133  
 Undo function, PWB 144, 204  
 Undocount switch, PWB 112, 246, 281  
 Unions generated by H2INC 642

UNIX  
   predefined expression syntax 846, 853  
   regular expression syntax 281–282, 843, 845–846,  
     848–849  
 Unixre switch 83, 281–282, 843  
 UNKNOWN keyword, EXETYPE statement 499  
 Unresolved external defined 872  
 Unsigned integer, predefined expression syntax 846, 848,  
   853  
 Unsigned numbers, predefined expression syntax 846,  
   848, 853  
 Up function, PWB 144, 205  
 Use 8514 Displays option, CodeView 311  
 Use Black-and-White Display option, CodeView 312  
 USE command, CodeView 399, 430  
 Use Language command, CodeView 399, 430  
 Use Two Displays option, CodeView 310  
 Use VGA Displays option, CodeView 311  
 User input statements 104–106  
 User switch, PWB 246–247, 282–283  
 User-defined constants  
   and H2INC 660  
   converting 660  
 User-defined type defined 872  
 Usercmd function, PWB 144, 205  
 UTILERR.HLP file 679  
 Utilities  
   extension, PWB Options menu 67  
   H2INC 634  
 UTILS.HELP file 679  
 UTILS.HLP file 681

## V

\v formatting attribute, HELPMMAKE 602, 604–605  
 \v formatting code, HELPMMAKE 610  
 /V option  
   EXEHDR 515, 521, 630  
   HELMMAKE 599  
   NMAKE 532, 563  
 /v option, BSCMAKE 621  
 Values, entering, CodeView 416–418  
 Variables  
   addresses, debugging assembly code 391  
   defined 872  
   editing, CodeView 324–325  
   environment *See* Environment variables  
   local, CodeView 328–329  
   .SBR files, PWB 94  
   scope, CodeView 422–424  
 VCPI server  
   *See also* Virtual Control Program Interface server  
   defined 872  
 /VERBOSE option, EXEHDR 515, 521, 630

Verbose output, HELPMAKE option, HELPMAKE option 599  
Vertical Scrollbars command, CodeView 342, 345  
VGA  
    and EGA displays, with CodeView 311  
    defined 872  
    display, specifying, CodeView 311  
Video graphics adapter defined 872  
View Back command, QuickHelp 678  
View History command, QuickHelp 678  
View Last command, QuickHelp 678  
View Memory command, CodeView 399, 412–413, 431–433  
View menu, PWB 678  
View Next command, QuickHelp 678  
View Output command, CodeView 347–349  
View References command, searching, PWB 78  
View Relationship command, PWB 68, 134  
View Source Command, CodeView 376  
View Source command, CodeView 399, 433–436  
VIO, /PM option 485  
Virtual Control Program Interface server, memory management, CodeView 308  
Virtual memory  
    browser database 617–618  
    defined 872  
VM command, CodeView 399, 412–413, 431–433  
VM.TMP 490  
VS command, CodeView 376, 399, 433–436  
Vscroll switch, PWB 246, 284

## W

W? command, CodeView 399, 436  
w, English word, predefined expression syntax 846, 848, 853  
/W option  
    HELMAKE 597, 605  
    LINK 488  
/WARNFIXUP option, LINK 488  
Watch command, CodeView 347–348  
Watch expressions  
    adding 339, 436  
    deleting 437  
    listing 339, 441  
    saving 317  
    setting 298–299  
Watch window  
    CodeView  
        exploring watch expressions 299  
        function 324–325  
        opening 348  
        overview 322

Watch window (*continued*)  
    expressions  
        adding, in CodeView 325  
        changing contents of, in CodeView 325  
Watchpoint defined 872  
WC command, CodeView 399, 437  
WDG command, CodeView 351, 357, 362, 399, 437–438  
WDL command, CodeView 351, 358, 399, 438  
WDM command, CodeView 358, 399, 439  
WGH command, CodeView 351, 360, 399, 439–440  
Which Reference? command, PWB  
    described 68  
    function 134  
White  
    color value 254  
    space  
        converting, PWB 257, 258  
        predefined expression syntax 846, 848, 853  
        searching, PWB 83, 85  
        tab switches, PWB 118–119  
        translating, PWB 271  
Width  
    HELMAKE text 597  
    switch, PWB 246, 284  
Wildcards  
    defined 872  
    HELMAKE syntax 595  
    makefiles 536  
    regular expression syntax 845, 847–848  
Window function, PWB 144, 206  
Window menu, PWB  
    described 69  
    predefined macros 135  
WINDOWAPI keyword, NAME statement 495  
WINDOWCOMPAT keyword, NAME statement 495  
Windows  
    CodeView  
        8087 window 330  
        Command window 326–328, 393  
        Help window 332  
        Local window 328–329  
        Memory windows 330–332  
        navigation 323  
        opening 347  
        overview 320–322  
        Register window 329–330  
        Source windows 324  
        Watch window 324–325  
    PWB  
        activating 244  
        cascade arrangement 216  
        closing 217  
        maximizing 168, 226  
        minimizing 171, 226



Windows (*continued*)PWB (*continued*)

- moving 172, 227
- opening 188, 206, 228
- resizing 236–237
- restoring 237
- selecting 198
- styles in 207, 256
- tiling 240, 278

Windows Dereference Global Handle command, CodeView 351, 360, 399

Windows Dereference Local Handle command, CodeView 351, 360, 399

Windows Display Global Heap command, CodeView 351, 357, 399, 437–438

Windows Display Local Heap command, CodeView 351, 358, 399, 438

Windows Display Modules command, CodeView 351, 358, 399, 439

Windows File Manager, starting PWB 59

WINDOWS keyword, EXETYPE statement 499

Windows Kill Application command, CodeView 360, 362, 399, 440–441

Windows menu, CodeView 347

Windows Program Manager

- help, getting 676
- starting, in PWB 58

Windows, programs for

- application type 514, 523
- character-mode application 485, 495
- creating, LINK 459, 466
- custom loader 498
- EXETYPE statement 499
- FORTRAN 498
- full-screen application 485, 495
- inserting text 496
- LIBRARY statement 496
- loader 498
- module-definition files *See* Module-definition files
- MS-DOS stub 497
- NAME statement 495
- /PM option, LINK 485
- private library 496
- protected mode 499
- real mode 499–500
- text window 485, 495
- version 499

Winstyle function, PWB 144, 207

WKA command, CodeView 351, 360, 362, 440–441

WL command, CodeView 399, 441

WLH command, CodeView 351, 360, 399, 441–442

WO operator, CodeView 381, 390–392

Word

- processor formatting, HELPMMAKE text 610

Word (*continued*)

- rich text format, HELPMMAKE 609
- switch, PWB 246, 284–285
- wrapping, PWB switches 246, 272, 286

Words

- English, regular expression syntax 846, 848, 853
- finding in CodeView 335–336

Wordwrap switch, PWB 246, 286

WX

- /? 659
- /A option 659
- /B option 659
- environment variable 660
- /H option 659
- /N option 659
- running 659
- running synchronously with the MS-DOS prompt 659
- using 659
- /W option 659

WX/WXServer

- about dialog box 658
- overview 657
- setting request check interval with timer delay 658

WXServer

- icon, hiding 658
- running 657
- using 657

**X**

(x), grouping 847, 854

x, repeat, regular expression syntax 845, 847–849

/x option, LINK 486

/X option, NMAKE 532

X command, CodeView 399, 443

:x command, HELPMMAKE 606

\{x\}, grouping, regular expression syntax 847

\(x), tagged expression 843

\(x), tagged expression 847

x#, repeat, syntax 845, 852

x\*, repeat, syntax 843, 845, 847, 852

x+, repeat, syntax 843, 845, 852

x@, repeat, syntax 845

x^n, 845, 853

XMS

*See also* Extended memory manager

- defined 872
- Keepmem switch, PWB 265
- server defined 872

(x!y!z!) alternation 854

xyz thing, alternation, syntax 843, 845, 847

## Y

:y command, HELPMAKE 606  
Yellow color value 254

## Z

:z command, HELPMAKE 606  
z, unsigned integer, predefined expression syntax 844,  
846, 851  
/Zd option  
    CL 296, 385–386  
    ML 296  
/Zd option, CL  
    and /CO option, LINK 473  
    and /LINE option, LINK 478  
/Zi option  
    CL 296, 385–386  
    ML 296  
/Zi option, CL  
    and /CO option, LINK 473  
    and /LINE option, LINK 478  
/Zn option and BSCMAKE 616  
/Zs option and BSCMAKE 616